



**HOTT 010**  
without LCD display



**HOTT 010D**  
with LCD display

**Features**

- **Outputs**
  - Humidity and temperature  
2 x 0-10 Vdc or 2 x 4-20 mA
  - As option passive (direct) temperature output  
such PT100, PT1000, Nickel, NTC 10K, NTC 1.8K,  
NTC 20K and PTC
- **Humidity measuring range range**  
0 to 100% r.H.  
(output corresponding to 0-10 Vdc or 4-20 mA)
- **Temperature measuring ranges**  
4 different measuring temperature ranges  
selectable by jumpers on pcb  
-35°C to +35°C, -35°C to +75°C, 0 to 50°C or 0 to +80°C.
- **Accuracy**
  - Humidity  
+/- 3% (20 to 80% r.H.), at +20°C  
otherwise +/- 5%
  - Temperature +/- 0.8 Kelvin at +20°C.
- **Long-term stability**
- **Small hysteresis**
- **Easy to fix penetration dept with mounting flange**
- **With or without LCD display**

**Ordering**

Type no.	Humidity output	Temp. output	LCD display
----------	-----------------	--------------	-------------

**Outdoor Humidity & Temperature Transmitter**

<b>HOTT 010</b>	0-10 Vdc	0-10 Vdc	No
<b>HOTT 420</b>	4-20 mA	4-20 mA	No
<b>HOTT 010D</b>	0-10 Vdc	0-10 Vdc	Yes
<b>HOTT 420D</b>	4-20 mA	4-20 mA	Yes

On request, extra passive output such  
PT100, PT1000, NI1000, NTC 1.8K, NTC 10K, NTC 20K.  
Ordering example: HRTT 010 PT1000.

**Technical data**

<b>Power supply</b>	24 Vac (+/-20%) and 15-36 Vdc (+/-10%) for 0-10 Vdc output 15-36 Vdc (+/- 10%) for 4-20 mA output (depending on working resistance)
<b>Power consumption</b>	< 1.1 Va / 24 Vdc ; < 2.2 VA / 24 Vac
<b>Sensor</b>	Digital humidity sensor with integrated temperature sensors, dew proof, small hysteresis, high long-term stability
<b>Sensor protection</b>	Membrane filter, plastic, exchangeable
<b>Humidity Measuring range</b>	0 to 100% r.H.
<b>Humidity Operation range</b>	0 to 95% r.H.
<b>Humidity Accuracy</b>	+/- 3% (20 to 80% r.H.), at +20°C otherwise +/- 5%
<b>Humidity Output</b>	0-10 Vdc or 4-20 mA
<b>Temperature Measuring range</b>	-35°C to +35°C, -35°C to +75°C, 0 to 50°C or 0 to +80°C. See table
<b>Temperature Operation range</b>	-35°C to +80°C
<b>Temperature Accuracy</b>	+/- 0.8 Kelvin at +20°C, depending on place of installation and mounting position.
<b>Ambient Temperature</b>	storage -25°C to +50°C, operation -50 to +50°C
<b>Enclosure</b>	Plastic material, polyamide, 30% glass-globe-reinforced with quick locking screws. color pure white (similar RAL9010)
<b>Cable gland</b>	M16, including strain relief
<b>Tube</b>	stainless steel, dia. 16 mm
<b>Probe length</b>	230 mm, on request 400 mm and 500 mm
<b>Mounting</b>	With supplied (attached) flange
<b>Long-term stability</b>	+/- 1% per year
<b>Protection class</b>	III (according to EN 60730)
<b>Protection type</b>	IP65 (according to EN 60529)
<b>Standards</b>	CE conformity according to EMC directive 2004/108/EC according to EN 61326-1:2006 according to EN 61326-2-3:2006

### Application/Description

The outdoor humidity and temperature transmitter HOTT measures the relative humidity and temperature.

It converts the measurands into standard signals of 0-10 Vdc or 4-20 mA and is optional available with or without display.

Display-versions show actual humidity and actual temperature.

Terminal box enclosure made of impact-resistant plastic with enclosure cover with quick-locking screws.

It has four switchable temperature ranges and is applied in non-aggressive dust-free ambiances in refrigeration, air conditioning, ventilation and clean room technology.

Relative humidity (in % r. H.) is the quotient of water vapour partial pressure divided by the saturation vapour pressure at the respective gas temperature.

These measuring transducers are designed for exact detection of humidity.

A digital long-term stable sensor is used as measuring element for humidity measurement.

Fine adjustment by the user is possible.

### Accessories

Sensor shield / protection TSWS for sun and weather 184x180x80mm, stainless steel





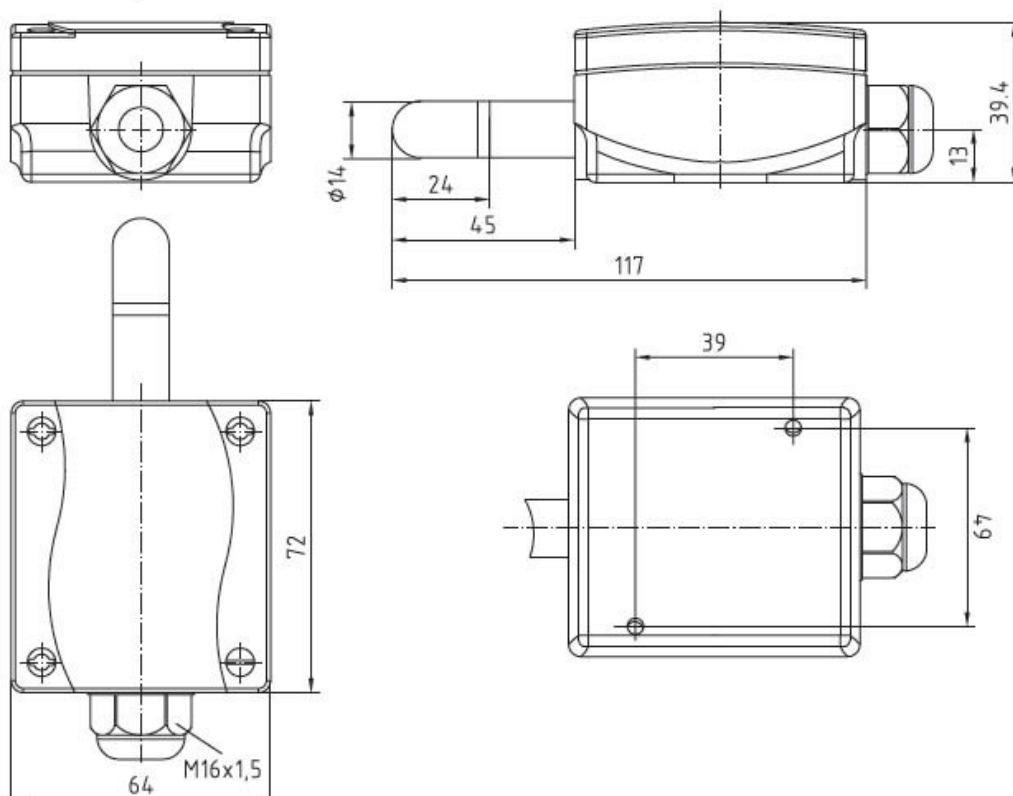

### Dimensions (mm)

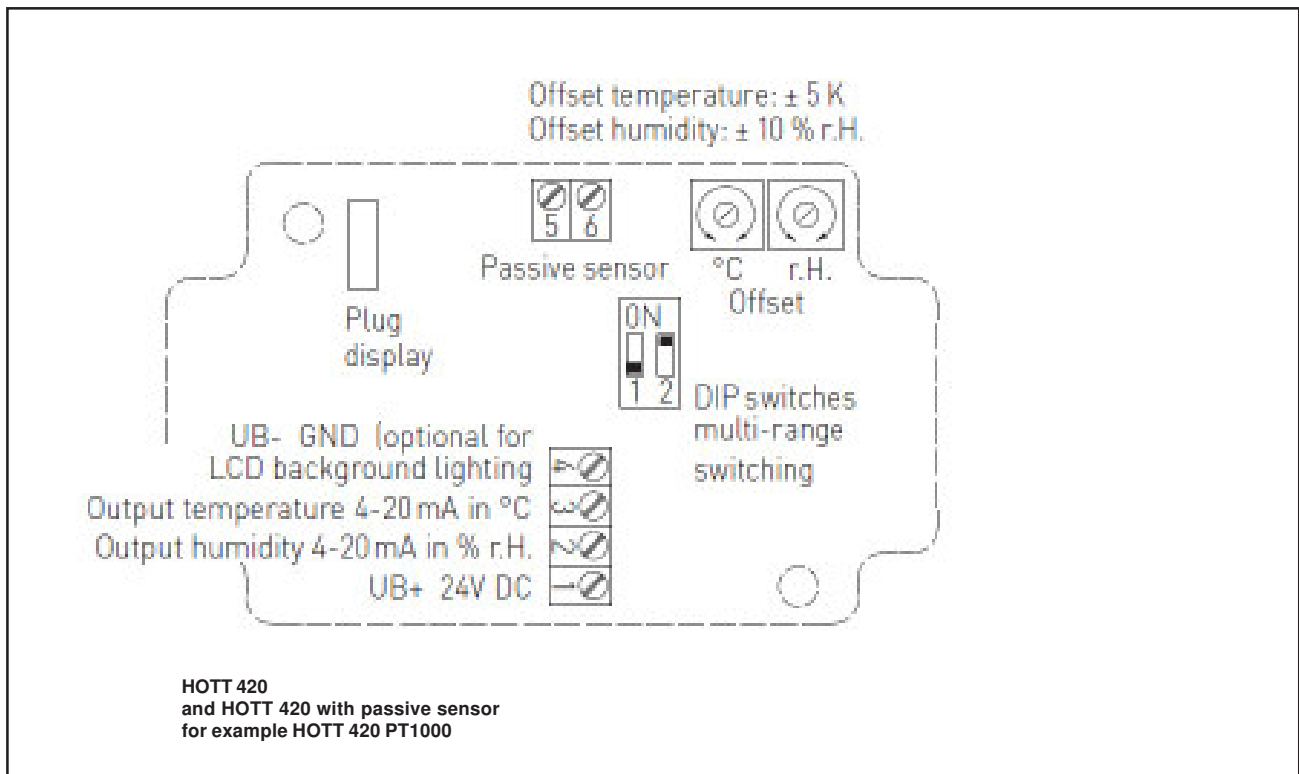
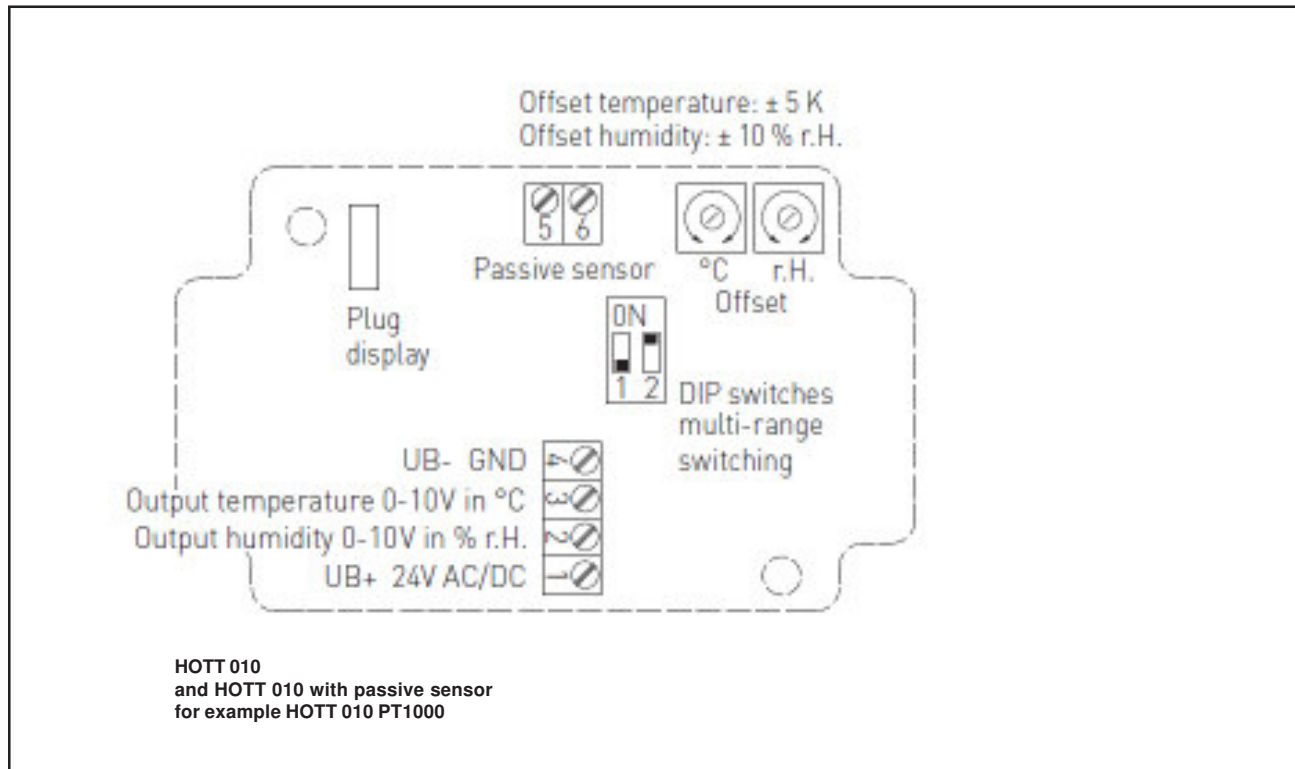









**Schematic diagrams**







**Electrical connection****HOTT 010**

-  1 +UB 24V AC/DC
-  2 Output humidity in % r.H. 0-10V
-  3 Output temperature in °C 0-10V
-  4 -UB-GND









**HOTT 010 with passive sensor**

-  1 +UB 24V AC/DC
-  2 Output humidity in % r.H. 0-10V
-  3 Output temperature in °C 0-10V
-  4 -UB-GND
  
-  5 Passive element 
-  6 e.g. Pt1000, Ni1000, 

**HOTT 420**

-  1 +UB 24V DC
-  2 Output humidity in % r.H. 4-20mA
-  3 Output temperature in °C 4-20mA
-  4 -UB-GND (optional for backlighting)

**HOTT 420 with passive sensor**

-  1 +UB 24V AC/DC
-  2 Output humidity in % r.H. 4-20mA
-  3 Output temperature in °C 4-20mA
-  4 -UB-GND (optional for backlighting)
  
-  5 Passive element 
-  6 e.g. Pt1000, Ni1000, 

**Temperature table** Range: -35...+75 °C

°C	U <sub>A</sub> in V	I <sub>A</sub> in mA
-35	0.0	4.0
-30	0.5	4.7
-25	0.9	5.5
-20	1.4	6.2
-15	1.8	6.9
-10	2.3	7.6
-5	2.7	8.4
0	3.2	9.1
5	3.6	9.8
10	4.1	10.5
15	4.5	11.3
20	5.0	12.0
25	5.5	12.7
30	5.9	13.5
35	6.4	14.2
40	6.8	14.9
45	7.3	15.6
50	7.7	16.4
55	8.2	17.1
60	8.6	17.8
65	9.1	18.5
70	9.5	19.2
75	10.0	20.0

**Temperature table** Range: -35...+35 °C

°C	U <sub>A</sub> in V	I <sub>A</sub> in mA
-35	0.0	4.0
-30	0.7	5.1
-25	1.4	6.3
-20	2.1	7.4
-15	2.9	8.6
-10	3.6	9.7
-5	4.3	10.9
0	5.0	12.0
5	5.7	13.1
10	6.4	14.3
15	7.1	15.4
20	7.9	16.6
25	8.6	17.7
30	9.3	18.9
35	10.0	20.0

Temperature measuring ranges (adjustable)	DIP 1	DIP 2
-35 °C ... +75 °C	<b>ON</b>	<b>ON</b>
-35 °C ... +35 °C	OFF	OFF
0 °C ... +50 °C	OFF	<b>ON</b>
0 °C ... +80 °C	<b>ON</b>	OFF

**Temperature table** Range: 0...+50 °C

°C	U <sub>A</sub> in V	I <sub>A</sub> in mA
0	0	4.0
5	1	5.6
10	2	7.2
15	3	8.8
20	4	10.4
25	5	12.0
30	6	13.6
35	7	15.2
40	8	16.8
45	9	18.4
50	10	20.0

**Temperature table** Range: 0...+80 °C

°C	U <sub>A</sub> in V	I <sub>A</sub> in mA
0	0.0	4.0
5	0.6	5.0
10	1.3	6.0
15	1.9	7.0
20	2.5	8.0
25	3.1	9.0
30	3.8	10.0
35	4.4	11.0
40	5.0	12.0
45	5.6	13.0
50	6.3	14.0
55	6.9	15.0
60	7.5	16.0
65	8.1	17.0
70	8.8	18.0
75	9.4	19.0
80	10.0	20.0

**Humidity table**

Range: 0...100 % r. H.

% r.H.	U <sub>A</sub> in V	I <sub>A</sub> in mA
0	0	4.0
5	0.5	4.8
10	1.0	5.6
15	1.5	6.4
20	2.0	7.2
25	2.5	8.0
30	3.0	8.8
35	3.5	9.6
40	4.0	10.4
45	4.5	11.2
50	5.0	12.0
55	5.5	12.8
60	6.0	13.6
65	6.5	14.4
70	7.0	15.2
75	7.5	16.0
80	8.0	16.8
85	8.5	17.6
90	9.0	18.4
95	9.5	19.2
100	10.0	20.0

**Note**

For 4...20 mA devices, DC voltage must be used (without residual ripple, see permissible range of load resistance diagram). Do not use pulsating DC voltage.

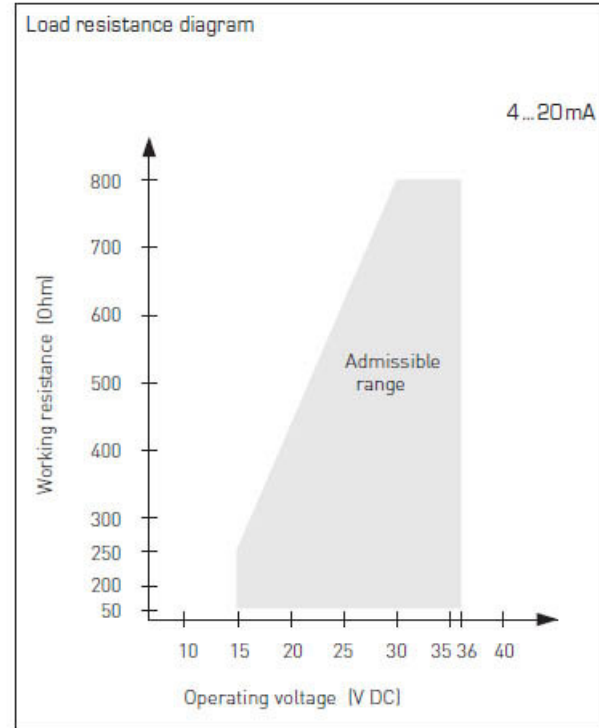

**Notes regarding products HOTT-series**

- This device may only be used in pollutant-free non-precipitating air without above-atmospheric or below-atmospheric pressure at the sensor element.
- On outdoor and duct sensors, the sinter filter of the sensor element protects the humidity sensor against potential dust exposure. In case of pollution / contamination, this filter should be cleaned on a regular basis.
- Dust and pollution falsify measurement results and are to be avoided. Slight pollution and dust sediments can be removed by using compressed air.
- Touching the humidity element is under any circumstances to be avoided, as that would result in considerable mismeasurements.
- In case of pollution, we recommend cleaning and recalibration in the factory.
- In any case, the sensor must not get in contact with chemicals or other cleaning agents.
- The relative humidity of 0...100 % is indicated by an output signal of 0 -10 V or 4...20 mA.

The device operating range covers 10.0...99.9 % r. H. Outside of that range, mismeasurements or increased deviations may occur.

- When several sensors (0 -10 V) are connected to one voltage supply of 24 V AC, correct polarity must be regarded as otherwise the alternating voltage source may be short-circuited.
- The voltage outputs are short-circuit proof. Applying overvoltage or voltage supply to the voltage output will destroy the device.
- If this device is operated beyond the specified range, all warranty claims are forfeited.

**General notes:**

- Devices must only be connected to safety extra-low voltage.
- To avoid damages and errors at the device (e.g. by voltage induction) shielded cables are to be used, laying parallel with current-carrying lines is to be avoided, and EMC directives are to be observed.
- This device shall only be used for its intended purpose. Respective safety regulations issued by the VDE, the states, their control authorities, the TUV and the local energy supply company must be observed.
- The purchaser has to adhere to the building and safety regulations and has to prevent perils of any kind.
- No warranties or liabilities will be assumed for defects and damages arising from improper use of this device.
- Consequential damages caused by a fault in this device are excluded from warranty or liability.
- These devices must be installed by authorised specialists only.
- The technical data and connecting conditions of the mounting and operating instructions delivered together with the device are exclusively valid. Deviations from the catalogue representation are not explicitly mentioned and are possible in terms of technical progress and continuous improvement of our products.
- In case of any modifications made by the user, all warranty claims are forfeited.
- This device must not be installed close to heat sources (e.g. radiators) or be exposed to their heat flow. Direct sun irradiation or heat irradiation by similar sources (powerful lamps, halogen spotlights) must absolutely be avoided.
- Operating this device close to other devices that do not comply with EMC directives may influence functionality.
- This device must not be used for monitoring applications, which solely serve the purpose of protecting persons against hazards or injury, or as an EMERGENCY STOP switch for systems or machinery, or for any other similar safety-relevant purposes.
- Dimensions of enclosures or enclosure accessories may show slight tolerances on the specifications provided in these instructions.
- Modifications of these records are not permitted.
- In case of a complaint, only complete devices returned in original packing will be accepted.

Our "General Terms and Conditions for Business" together with the "General Conditions for the Supply of Products and Services of the Electrical and Electronics Industry" (ZVEI conditions) including supplementary clause "Extended Retention of Title" apply as the exclusive terms and conditions".

We reserve the right to make changes in our products without any notice which may effect the accuracy of the information contained in this leaflet.