

AUTO POUR

USER SUPPLEMENT

PUBLICATION N° 812877

LANGUAGE: ENGLISH



Auto Pour System for Molten Metal Temperature Measurement



LAND
AMETEK[®]
PROCESS & ANALYTICAL INSTRUMENTS



QUALITY CUSTOMER SOLUTIONS

Health and Safety Information



Read all of the instructions in this booklet - including all the **WARNINGS** and **CAUTIONS** - before using this product. If there is any instruction which you do not understand, **DO NOT USE THE PRODUCT.**

Safety Signs



WARNING

Indicates a potentially hazardous situation which, if not avoided, could result in death or personal injury.



CAUTION

Indicates a potentially hazardous situation which, if not avoided, could result in minor or moderate injury to the user or users, or result in damage to the product or to property.

NOTE

Indicates a potentially hazardous situation which, if not avoided, could result in damage or loss of data.

Signs and Symbols used on equipment and Documentation



Caution, risk of electric shock.



Caution, attention to possibility of risk of damage to the product, process or surroundings. Refer to instruction manual.



Caution, hot surface.



Protective Conductor Terminal.



Observe precautions for handling electrostatic discharge sensitive devices.

Equipment Operation

Use of this instrument in a manner not specified by AMETEK Land may be hazardous. Read **and understand** the user documentation supplied **before** installing and operating the equipment.

The safety of any system incorporating this equipment is the responsibility of the assembler.

Protective Clothing, Face and Eye Protection

It is possible that this equipment is to be installed on, or near to, machinery or equipment operating at high temperatures and high pressures. Suitable protective clothing, along with face and eye protection must be worn. Refer to the health and safety guidelines for the machinery/equipment before installing this product. If in doubt, contact AMETEK Land.

Electrical Power Supply

Before working on the electrical connections, all of the electrical power lines to the equipment must be isolated. All the electrical cables and signal cables must be connected exactly as indicated in these operating instructions. If in doubt, contact AMETEK Land.

Storage

The instrument should be stored in its packaging, in a dry sheltered area.

The maximum storage temperature is 10°C (18°F) higher than the maximum operating temperature.

The minimum storage temperature is 10°C (18°F) lower than the minimum operating temperature.

Refer to the Technical Specification for details of the operating temperature limits.

Unpacking

Check all packages for external signs of damage. Check the contents against the packing note.

Lifting Instructions

Where items are too heavy to be lifted manually, use suitably rated lifting equipment. Refer to the Technical Specification for weights. All lifting should be carried out in accordance with local and national regulations.

Contact Us

UK - Dronfield

Land Instruments International

Tel: +44 (0) 1246 417691

China

AMETEK Land China Service

Tel: +86 21 5868 5111 ext 122

USA - Pittsburgh

AMETEK Land, Inc.

Tel: +1 412 826 4444

India

AMETEK Land India Service

Tel: +91 - 80 67823240

Email: land.enquiry@ametek.com

Web: www.ametek-land.com

For further details on all AMETEK Land offices, distributors and representatives, please visit our website.

Return of Damaged Goods

IMPORTANT If any item has been damaged in transit, this should be reported to the carrier and to the supplier immediately. Damage caused in transit is the responsibility of the carrier not the supplier.

DO NOT RETURN a damaged instrument to the sender as the carrier will not then consider a claim. Save the packing with the damaged article for inspection by the carrier.

Return of Goods for Repair

If you need to return goods for repair please contact our Customer Service Department for details of the correct returns procedure.

Any item returned to AMETEK Land should be adequately packaged to prevent damage during transit.

You must include a written report of the problem together with your own name and contact information, address, telephone number, email address etc.

Design and Manufacturing Standards

The Quality Management System of Land Instruments International is approved to BS EN ISO 9001 for the design, manufacture and on-site servicing of combustion, environmental monitoring and non-contact temperature measuring instrumentation.

Registered ISO 9001 Management System approvals apply in the USA.

UK Calibration Laboratory: UKAS 0034.

USA Calibration Laboratory: ANAB Accredited ISO/IEC 17025.

National Accreditation Board for Testing and Calibration Laboratories approvals apply in India.

Operation of radio transmitters, telephones or other electrical/electronic devices in close proximity to the equipment while the enclosure doors of the instrument or its peripherals are open, may cause interference and possible failure where the radiated emissions exceed the EMC directive.

The protection provided by this product may be invalidated if alterations or additions are made to the structural, electrical, mechanical, pneumatic, software or firmware components of this system. Such changes may also invalidate the standard terms of warranty.

Copyright

This manual is provided as an aid to owners of AMETEK Land's products and contains information proprietary to AMETEK Land. This manual may not, in whole or part, be copied, or reproduced without the expressed written consent of AMETEK Land.

Copyright © 2018 Land Instruments International.



Contents

1	Introduction	1-1
1.1	About this Supplement Guide	1-1
1.2	About the Processor	1-1
2	Installing the Auto Pour System	2-1
2.1	System Installation	2-1
2.2	Electrical Connections	2-2
3	Using the Processor	3-1
3.1	Getting Started (accessing the menu system)	3-1
3.2	About the Channel Configuration Menu	3-2
3.3	Adjusting items in the Channel Configuration Menu	3-3
3.4	Thermometer Type	3-3
3.5	Non Greyness	3-4
3.6	Auto Pour Time Function	3-4
4	Software	4-1
4.1	To connect your LMG MkII to SPOTViewer	4-1
4.2	Logging On Value Change	4-1

A decorative graphic in the top left corner. It features a large, bold, black number '1' on a light gray background. To the right of the '1', there are several overlapping, semi-transparent gray parallelograms that create a sense of depth and movement. A bright green parallelogram is positioned at the top right of this graphic, pointing towards the right edge of the page.

1

INTRODUCTION



1 Introduction

1.1 About this Supplement Guide

This supplement guide gives you the specific information necessary for you to install and operate a Landmark Graphic MkII signal processor (LMG MkII) with an Auto Pour processing card & Spot Viewer logging software.

This guide must be read in conjunction with the standard LMG MkII User Guide and the standard Spot Viewer Software User Guide.

It covers the electrical installation, Auto Pour specific touchscreen displays and menu system, explains the Auto Pour signal processing, and explains how to connect the Spot Viewer Software to the LMG MkII.

Electronic copies of this User Guide can be obtained from the LAND website **www.ametek-land.com**.

1.2 About the Processor

The LMG MkII signal processor with Auto Pour card is designed to be used in conjunction with AMETEK Land R1 infrared thermometers and Auto Pour specific software for data logging.

The processor features include:

- Large, clear, bright full colour LCD touchscreen with wide viewing angle
- Easy to use configuration menu system, with security code, context-sensitive help display and 'Quick Key' selection of the most commonly changed parameters
- Language choice for the display text
- An additional Auto Pour function processing algorithm
- A choice of time function processing options for each thermometer input
- Current and voltage retransmission output for SCADA connections
- +24 V dc Power input (separate DIN rail power supply for mains inputs)
- Serial communications as standard in RS 485 format
- A front panel cover which provides sealing to IP65 standards

The software features include:

- Automatic 'logging on value change' which logs the final average temperature value of each pour

END OF SECTION

A decorative graphic at the top of the page. It features a large, bold, dark grey number '2' on the left. To the right of the '2' is a series of overlapping, semi-transparent grey rectangular shapes that create a sense of depth and movement. On the far right, a solid green triangle points towards the center, partially overlapping the grey shapes.

2

INSTALLING THE AUTO POUR SYSTEM

2 Installing the Auto Pour System

2.1 System Installation

This guide gives you the specific information necessary for you to install and operate a Landmark Graphic MkII signal processor (LMG MkII) with an Auto Pour processing card.

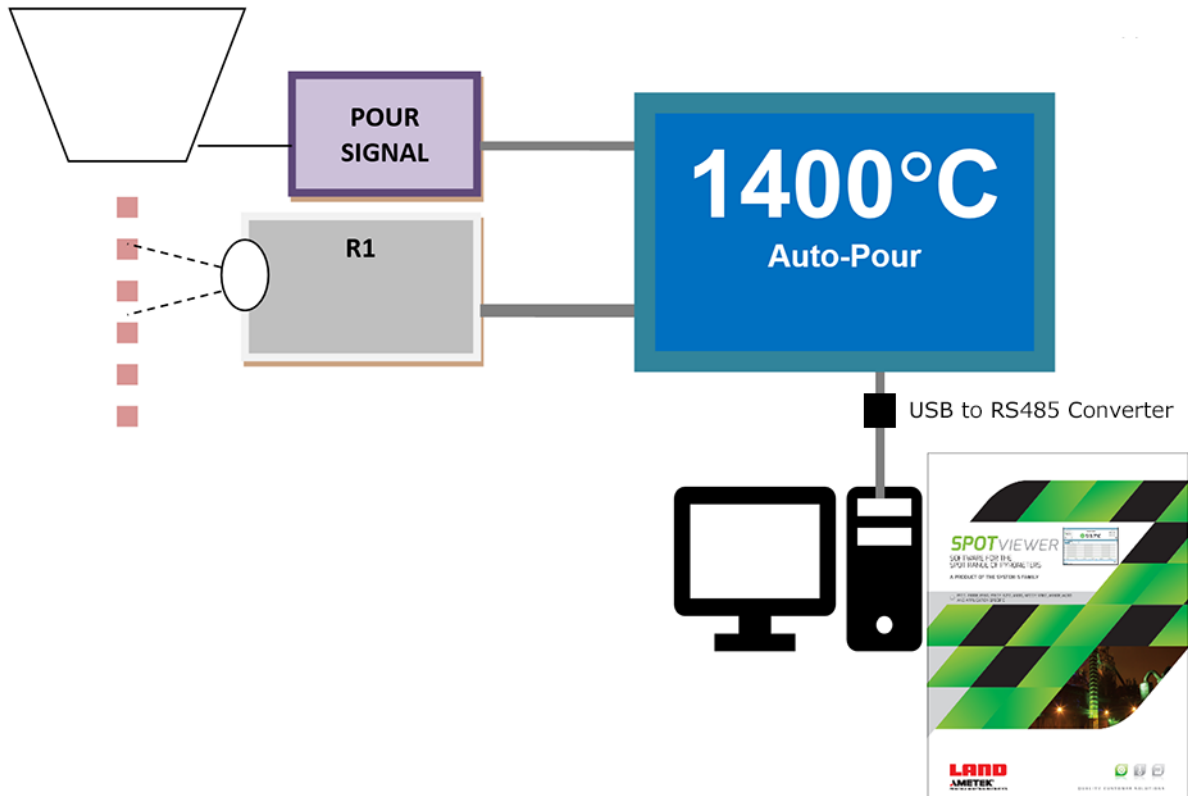


Fig. 2-1 Auto Pour System Overview

- The system requires the user to provide a signal indicating when the pour is taking place
- A System 4 R1 thermometer is aimed to cover the area where the pour emerges – it is not necessary to fill the field of view of the thermometer with the hot pouring metal
- The LMG MkII will calculate the average temperature of the poured metal
- The result of the calculation will be logged by the SPOT Viewer Software

2.2 Electrical Connections

The electrical connections to and from the processor are all made via connectors on the rear panel of the processor. Fig. 2-2 shows the location of the connectors.

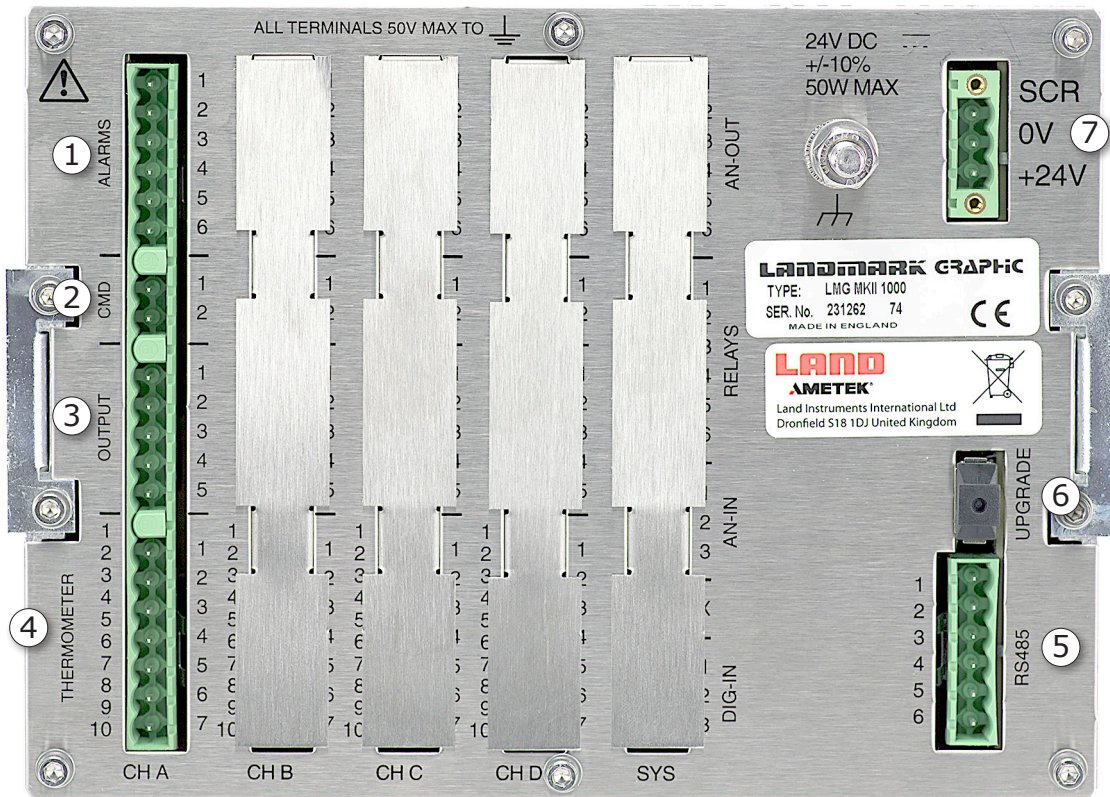


Fig. 2-2 Rear panel electrical connections

1	Alarm output (optional)
2	Command input (CMD) - connect to the Pour signal - See 2.2.1
3	Retransmission output (optional)
4	Thermometer connector – connect to the R1 thermometer – see 2.2.2
5	RS485 serial communications output – connect to the computer – see 2.2.4
6	USB update port (optional)
7	Power input +24Vdc – connect to the power supply – see 2.2.3

2.2.1 CMD (Command) input connection schedule

The CMD (Command) input connection schedule is given in Fig. 2-3.

The command signal is inactive when the voltage is >3.0 V or open circuit (i.e. Track)

The command signal is active when the voltage is <1.5V or short circuit (i.e. Hold).

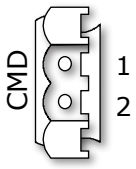
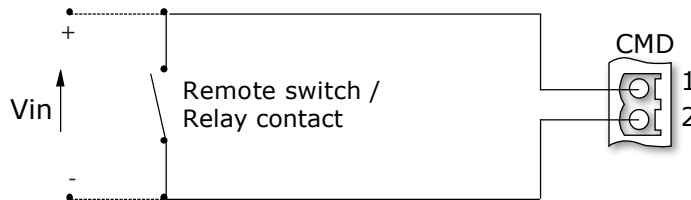
Pin N°	Function	Description	
	1	CMD+	Command input drive Command input return
	2	CMD-	

Fig. 2-3 CMD (Command) cable connection schedule

The command input can be controlled via a remote switch/relay contact, as shown in Fig. 2-4.



	Peak Picker	Track & Hold
Switch open	Peak Pick	Track
Switch closed	Reset	Hold

Fig. 2-4 CMD (Command) input control via a remote switch/relay contact

2.2.2 Thermometer connection schedule

The thermometer connection schedule is given in Fig. 2-5.

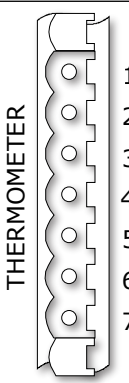
Pin N°	Cable Colour	Function		
	1	Yellow	T+	T Temperature signal from thermometer
	2	Blue	T-	
	3	White	E+	E Emissivity signal to thermometer
	4	Screen	Screen	
	5	Red	V+	V Power supply to thermometer
	6	Black	V-	
	7	Green	E-	

Fig. 2-5 Thermometer connection schedule

2.2.3 DC power input

The dc power input connection schedule is given in Fig. 2-6.

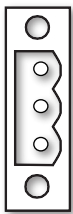
Pin N°	Function
	SCR
	0V
	+24V

Fig. 2-6 DC power input connection schedule

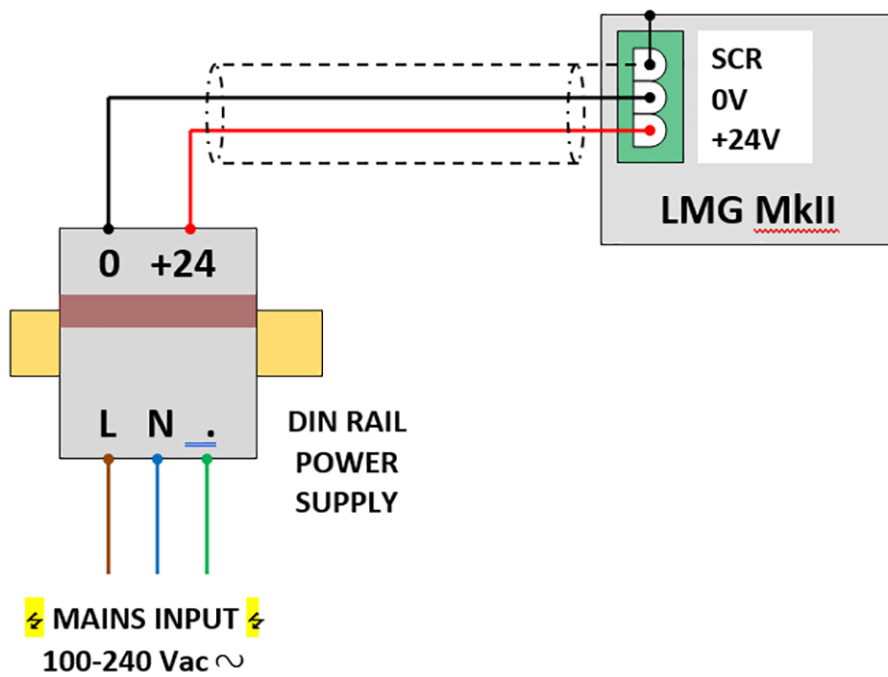


Fig. 2-7 DC power input from Power Supply

2.2.4 RS485 connections

The signals available on the RS485 connector, on the rear panel of the Landmark Graphic MkII Processor, are shown in Fig. 2-8.

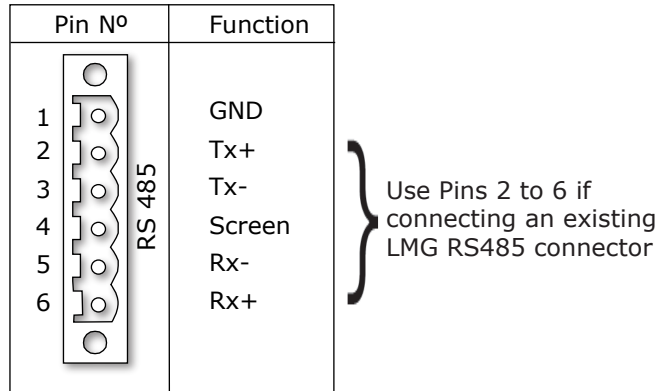
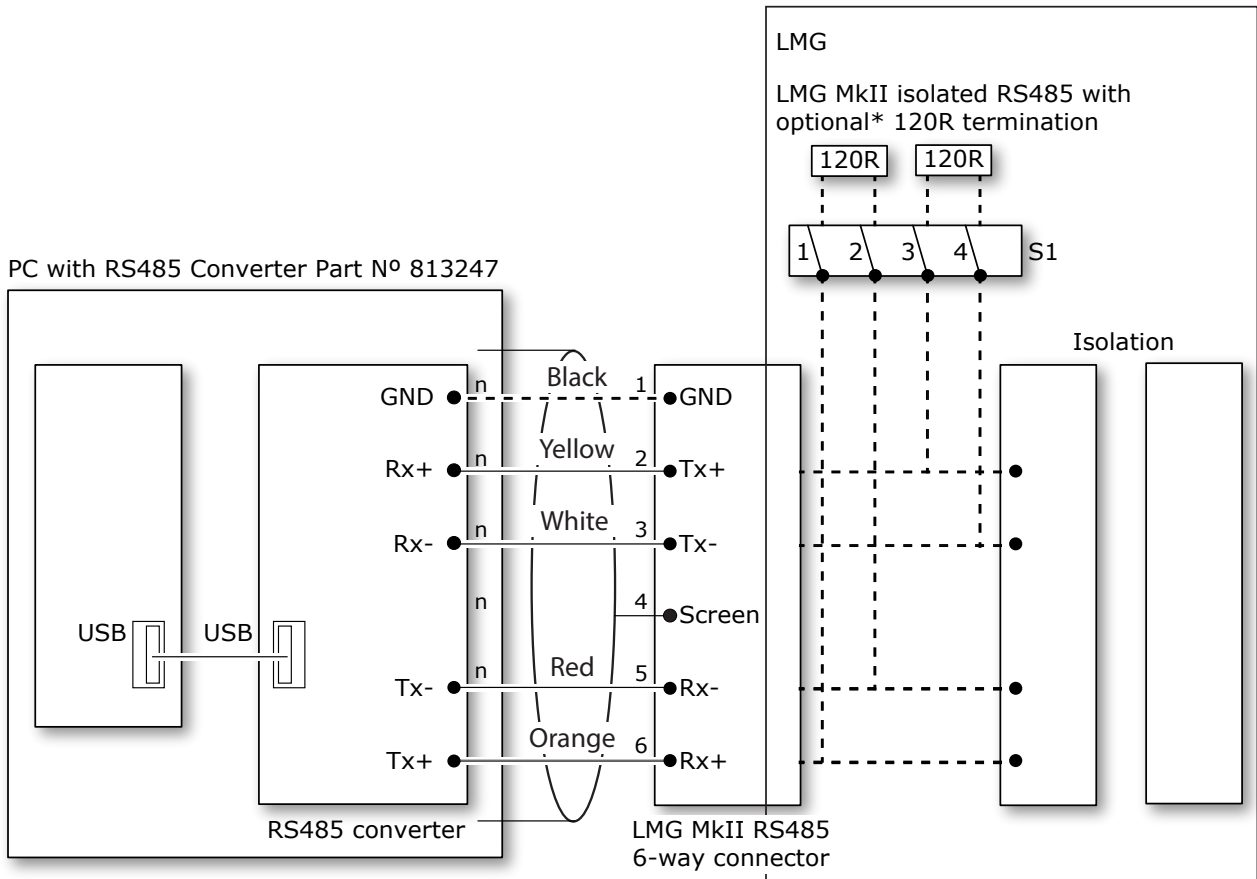


Fig. 2-8 RS485 interface connector on rear panel of processor



*Remove rear cover of LMG MkII to access S1

Fig. 2-9 RS485 interface connections

A decorative graphic at the top of the page. It features a large, bold, dark grey number '3' on the left. To the right of the '3' is a series of overlapping, semi-transparent grey rectangular shapes that create a sense of depth and movement. On the far right, a solid green triangle points towards the top right corner.

3

USING THE PROCESSOR

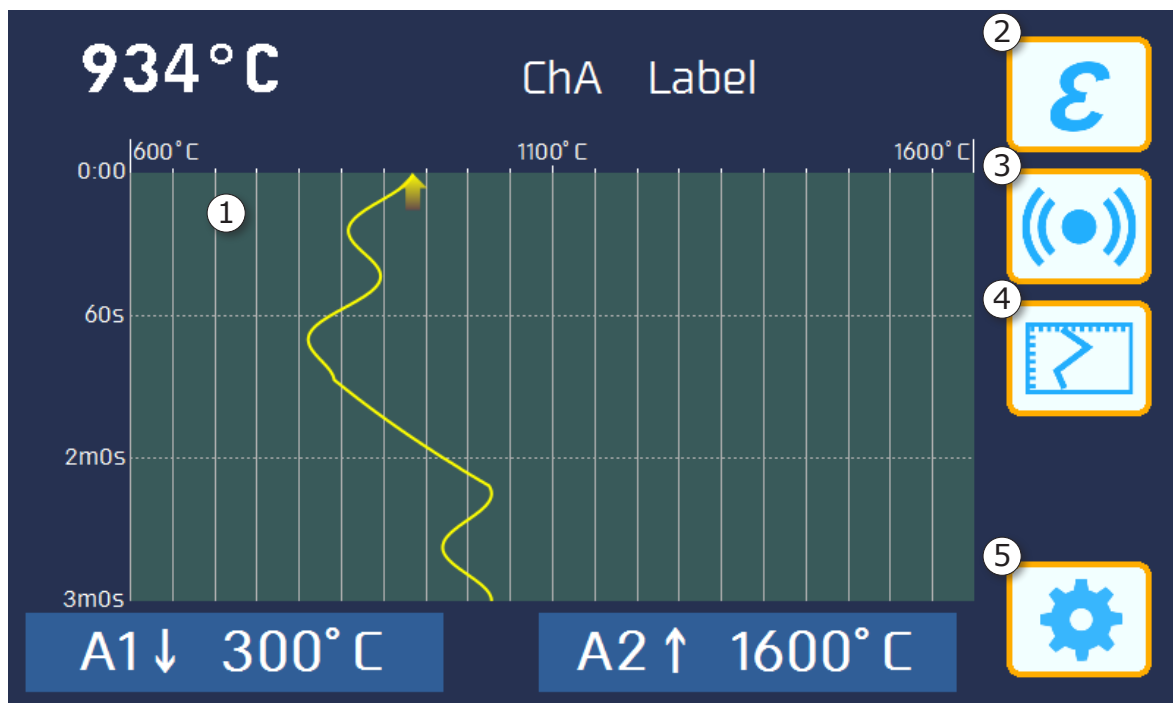
3 Using the Processor

Once the processor has been installed as described in Section 2, it must be configured, via the processor’s menu system, using the touchscreen display on the front panel. The location of the controls is given in Fig. 3-1.

3.1 Getting Started (accessing the menu system)

When the Landmark Graphic MkII processor is connected to a System 4 R1 thermometer and a suitable power supply, the processor display will be similar to that shown in Fig. 3-1.

On the left is the Temperature Display area (1). On the right are 3 ‘Quick’ buttons (2), (3) & (4), to access the commonly adjusted parameters quickly. To access the configuration menus, and set up your system to your particular requirements, press the **Settings** button (5)



1	Touch screen display
2	Emissivity adjustment ‘Quick button’
3	Alarm settings ‘Quick button’
4	Display selector ‘Quick button’
5	Settings menu

Fig. 3-1 Front panel touchscreen display and controls

3.2 About the Channel Configuration Menu

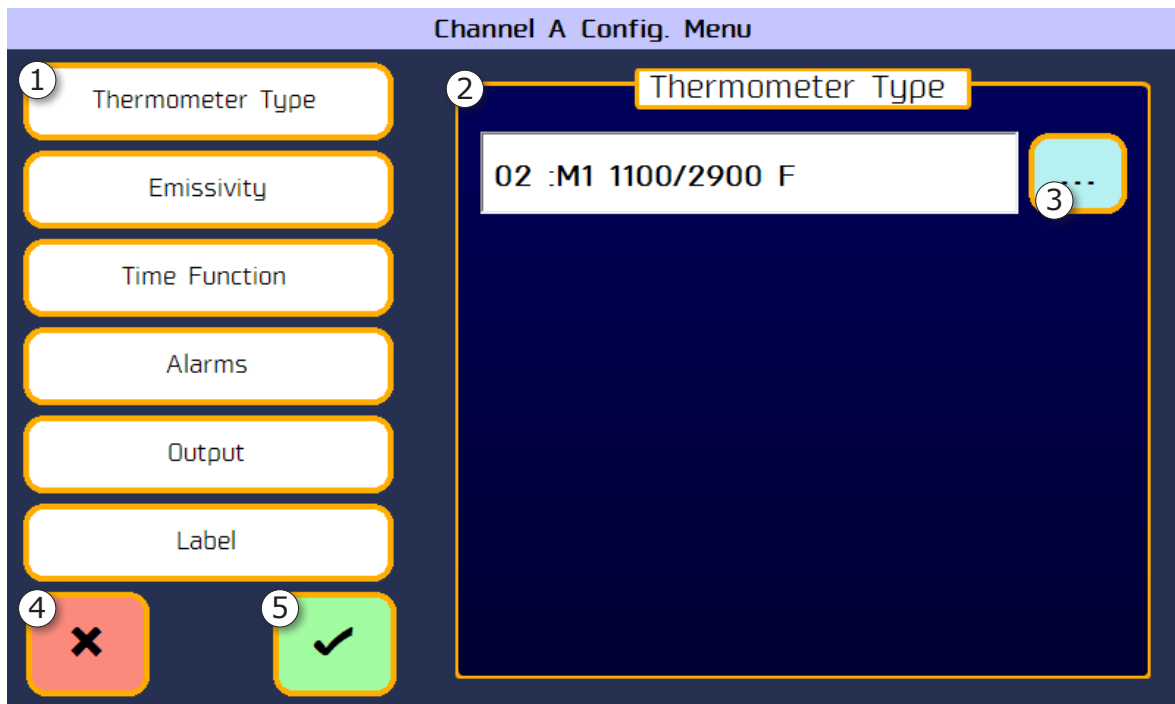


Fig. 3-2 Configuration Menu components

Each Channel Configuration Menu comprises the components shown in Fig. 3-2.

The function of each component of the menu is as follows.

- | | |
|------------------|----------------------------------------------------------------------------------------|
| ① Main Menu | This shows the items that can be altered in the Configuration Menu. |
| ② Sub Menu | This shows the list of options available for each main item in the Configuration Menu. |
| ③ Browse Button | Allows selection of the options available in this item. |
| ④ Cancel Button | Discards any changes and returns to the previous screen. |
| ⑤ Confirm Button | Saves and applies any changes and returns to the previous screen. |

3.3 Adjusting items in the Channel Configuration Menu


- 1) Select an item from the Main Menu ①
The sub-menu ② relating to the selected item is activated.
- 2) Use the on-screen controls ③ to select the required value for the item.
- 3) To save your changes and exit the Configuration menu, press the Confirm button ⑤ (or to discard your changes press Cancel ④).
The Main Configuration menu is displayed.
- 4) To exit the Main Configuration Menu, press Cancel ④.

Details of the configurations available are in the main LMG MkII Processor User Guide as follows:

The following items must be set for correct operation of the auto pour system

- Thermometer Type - Section 3.4
- Emissivity/Non Greyness - Section 3.5
- Time Functions - Section 3.6

3.4 Thermometer Type

- 1) To access the Configuration Menu, press the Settings button 
- 2) Select the Thermometer Type option. A typical Thermometer Type display is shown in Fig. 3-3.

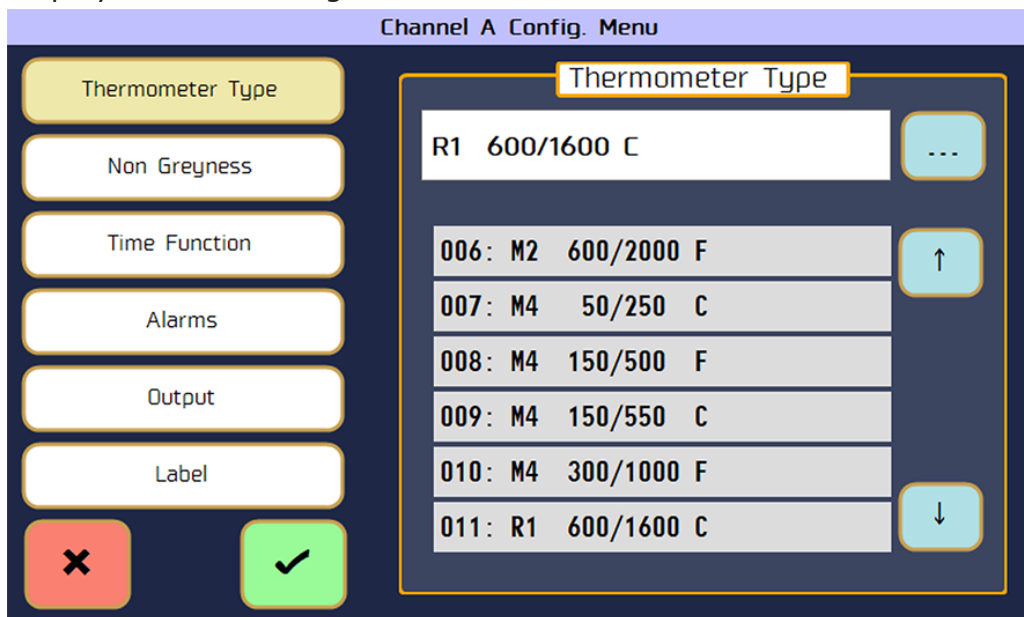


Fig. 3-3 Thermometer Type display

- 3) Navigate through the list of thermometer types and select **R1 600/1600 C** the exact System 4 thermometer type & temperature range that you have connected to a particular channel.
This is important because the LMG MkII applies additional corrections based on the thermometer type in order to achieve the highest possible system accuracy.
If an incorrect type is selected, then the wrong correction will be applied. It also sets the range of temperature values allowed in other channel configuration parameters.

3.5 Non Greyness

Select the Non-Greyness option. The Set Non Greyness display is shown in Fig. 3-4.



Fig. 3-4 Non Greyness display

3.6 Auto Pour Time Function

The LMG MkII contains a number of Time Function algorithms which help deliver a more consistent temperature reading from a sometimes noisy, changeable reading from the infrared thermometer.

In particular the Auto Pour function works as follows.

The Pour signal controls an averager function within the LMG MkII. For the duration of the Pour signal being active the LMG MkII will compute the average of the signal during that time, and will update its output on the falling edge

Although the R1 thermometer is designed to work with an incomplete field of view, Upper and Lower thresholds are set above and below the temperature range of interest. The LMG MkII will exclude from the averager all values above and below these thresholds.

These help to exclude high temperature and low temperature anomalies from the data stream from affecting the average value.

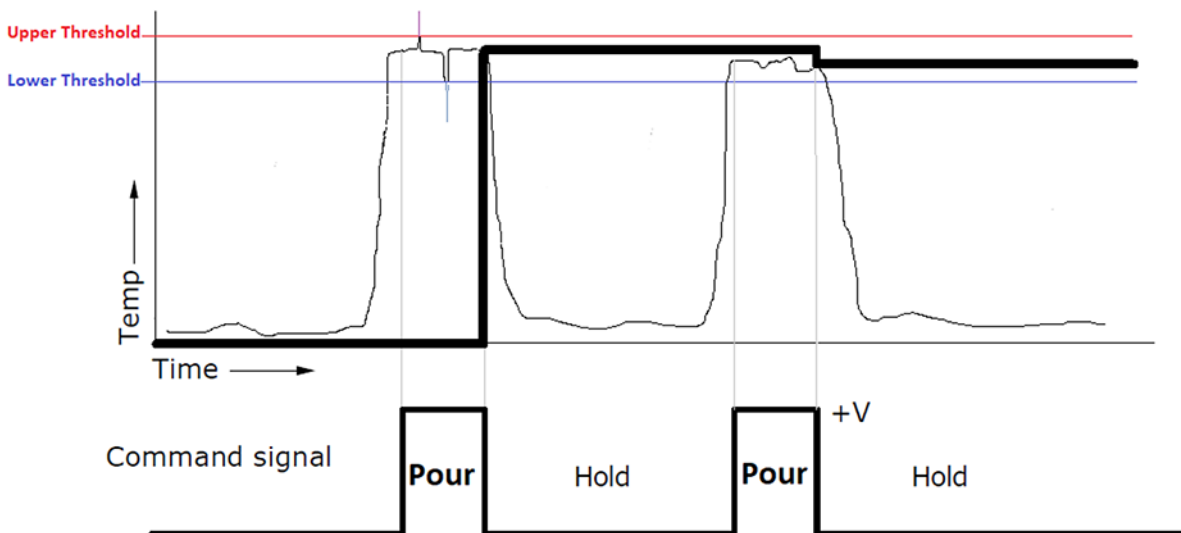


Fig. 3-5 Auto Pour Time Function Processing

The following sections help you select and configure the Auto Pour function. The time functions available are shown in Fig. 3-6.

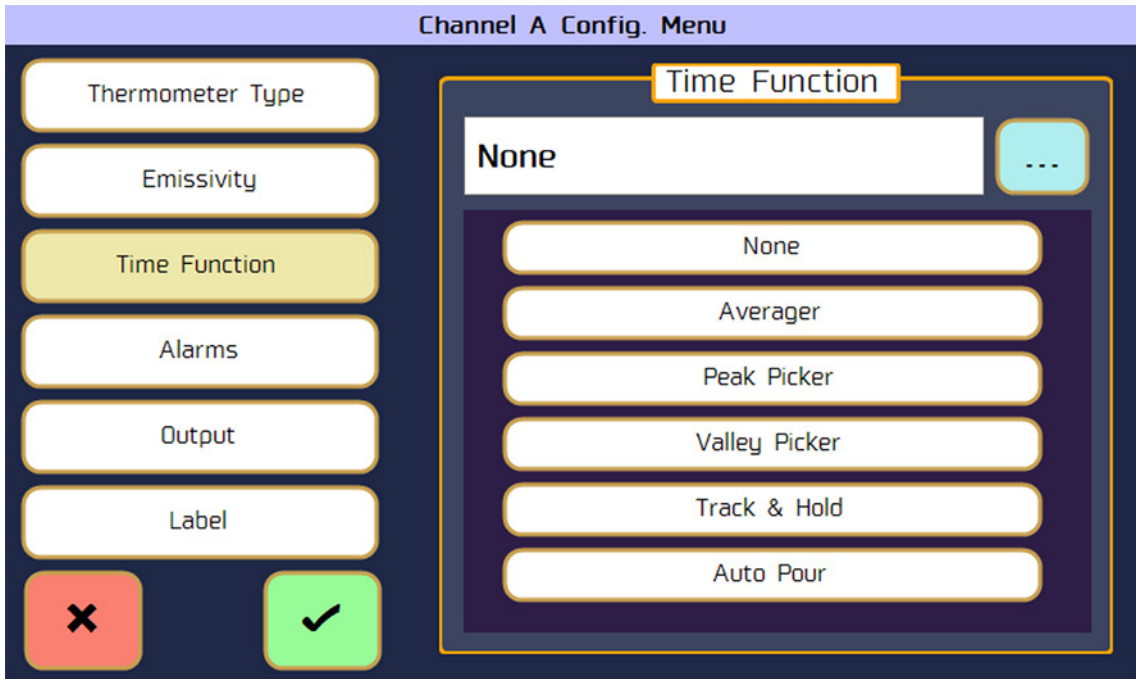


Fig. 3-6 Time Function processing menu

Choose the **Auto Pour** function from the bottom of the list. This then brings up the **Auto Pour** configuration screen in which you can select the upper and lower thresholds, as shown in Fig 3-7.

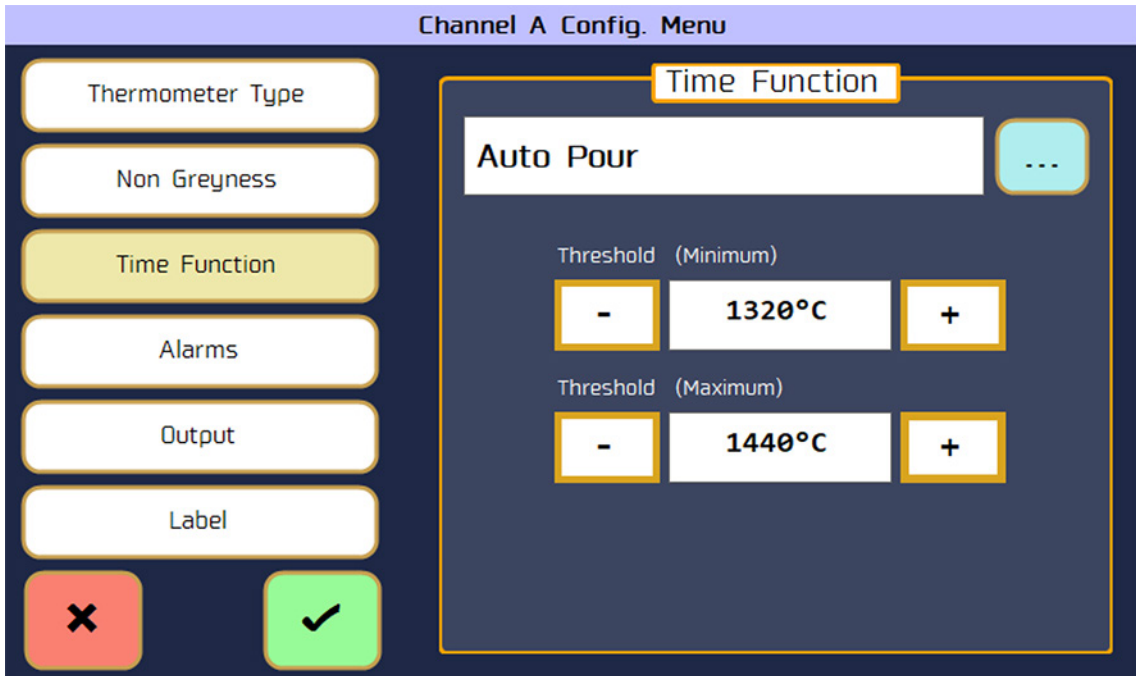


Fig. 3-7 Auto Pour configuration menu

END OF SECTION

A decorative graphic at the top of the page. It features a large, bold, black number '4' on the left. To the right of the '4' is a series of overlapping, semi-transparent gray parallelograms that create a sense of depth and movement. On the far right, a solid green parallelogram is positioned, partially overlapping the gray ones.

4

SOFTWARE

4 Software

SPOTViewer is a free software application for Windows PCs which is available for download from the AMETEK Land Website. Versions 5.1.1 and above support LMG MkII with Auto Pour functionality.

An RS485 to USB interface is required to connect the LMG MKII to a Windows PC. Refer to Section 2.2.4 for further information.

For general installation and operational instructions of SPOTViewer, please refer to the SPOTViewer user guide.

4.1 To connect your LMG MkII to SPOTViewer

- 1) Open the Devices window by clicking on the **Devices** button on the menu.
- 2) Remove the pre-configured SPOT and Actuator devices from the Devices list by selecting them and pressing the **Delete** button.



- 3) Press the manual **Add** button to add a new device.



- 4) Enter a name for the device and select **LMG MkII** from the Type drop-down box.
- 5) Select the **COM Channel** to which the LMG MkII device is connected on your PC.
- 6) The remaining connection settings must match the settings applied in the LMG MkII.
- 7) Press **OK**. SPOTViewer will connect to the LMG MkII Auto Pour card.

Add Device

Name	<input type="text" value="LMG"/>
Type	<input type="text" value="LMG MkII"/>
Serial Communications	
COM Channel	<input type="text"/>
LMG Address	<input type="text" value="0"/>
Card	<input type="text" value="A"/>
Baud Rate	<input type="text" value="57600"/>
Data Bits	<input type="text" value="8"/>
Parity	<input type="text" value="None"/>
Stop Bits	<input type="text" value="1"/>
<input type="button" value="OK"/> <input type="button" value="Cancel"/>	

4.2 Logging On Value Change

To log data only when the value is changed:

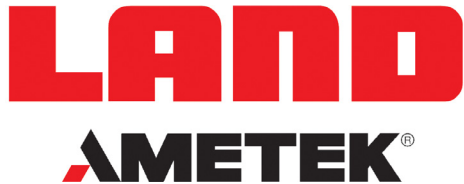
- 1) Click on the **Data > Triggers** menu option.
- 2) Create a new Trigger.
- 3) Name the trigger and select the **Conditional** type and press Next.
- 4) Select the Data to log and press Next.
- 5) Change the **Mode** to **OnValueChanged**.
- 6) Press **Next** and **Exit**.
- 7) Go to the **Data** tab of the Data Logging window.
- 8) Select the Data to log and press **Add**.
- 9) On the **Mode** column of the data added, select the trigger you have just created.
- 10) Press **OK**. Data will now only be logged on data change.

END OF SECTION



AUTO POUR

APPLICATION DEDICATED SYSTEM



Land Instruments International

Dronfield, S18 1DJ,
England
Tel: +44 (0) 1246 417691
Email: land.enquiry@ametek.com
www.ametek-land.com

AMETEK Land - Americas

150 Freeport Road, Pittsburgh,
PA 15238, U.S.A.
Tel: +1 (412) 826 4444
Email: irsales@ametek.com
www.ametek-land.com

AMETEK Land China Service

Part A1 & A4, 2nd Floor #1
No. 26 Fute 3rd Road East,
Pilot Free Trade Zone 200131
Shanghai, China
Tel: +86 21 5868 5111 ext 122
Email: land.enquiry@ametek.com
www.ametek-land.com

AMETEK Land India Service

Divyasree N R Enclave, Block A,
4th Floor, Site No 1, EPIP Industrial Area
Whitefield, Bangalore- 560066 Karnataka,
India
Tel: +91 - 80 67823240
Email: land.enquiry@ametek.com
www.ametek-land.com

For a full list of international offices, please visit our website www.ametek-land.com

Copyright © 2019 LAND Instruments International.

Continuous product development may make it necessary to change these details without notice.

Auto Pour System User Supplement, Issue 2, 22 May 2019