



Installation and operating instructions

Intelligent paperless recorder

DS 500 mobile



I. Foreword

Dear customer,

thank you very much for deciding in favour of the DS 500 mobile. Please read this installation and operation manual carefully before mounting and initiating the device and follow our advice. A riskless operation and a correct functioning of the DS 500 are only guaranteed in case of careful observation of the described instructions and notes.



II. Table of contents	
I. Foreword	2
II. Table of contents	3
1 Safety instructions	7
1.1 General	7
1.1 Installation	8
2 Application area	9
3 Intended use	10
4 Technical data DS 500	11
5 Input signal	12
6 Cable cross-section	12
7 Connection diagrams of the different sensor types	13
7.1 Connector pin assignment for all sensors A.1 – A.4, B.1 – B.4, C.1 – C.4	13
7.2 Connection diagrams	14
7.2.1 Connection CS dew point sensors, serial FA 415/FA 300	14
7.2.2 Connection for dew point- and consumption sensors, serial FA/VA 400	14
7.2.3 Connection for dew point- and consumption sensors, serial FA/VA 5xx.....	14
7.2.4 Connection pulse sensor	15
7.2.5 Analogue two-, three-, and four-wire current signal.....	16
7.2.6 Three- and four-wire power supply 0 - 1/10/30 VDC	17
7.2.7 Two-, three-, and four-wire connector pin assignments for PT100/PT1000/KTY81.....	18
7.3 Connection with RS485	18
8 Connect the DS 500 with a PC	19

9	Operation DS 500	20
9.1	Main menu (Home)	20
9.1.1	Initialization	20
9.1.2	Main menu after initialization	21
9.2	Shutdown	21
9.3	Settings	22
9.3.1	Password settings	22
9.3.2	Sensor settings	23
9.3.2.1	Choice of the sensor type (For example type CS-Digital sensor)	23
9.3.2.2	Label and setting the description fields	26
9.3.2.3	Name the measurement data and define the decimal places	26
9.3.2.4	Recording measurement data	27
9.3.2.5	Alarm settings	28
9.3.3	Dewpoint sensor with type CS-Digital	30
9.3.4	Flow sensor VA 400 / VA 420 of type CS-Digital (SDI Bus)	31
9.3.4.1	More-Settings (scale analogue output)	34
9.3.5	Dew Point Sensor of type FA 5xx (RS 485 Modbus)	35
9.3.5.1	Settings Dew point sensor FA 500 / FA 510	36
9.3.5.1.1	Unit selection for temperature and humidity	36
9.3.5.1.2	Definition of the System pressure (relative pressure value)	36
9.3.5.1.3	Definition of Reference pressure (absolute pressure value)	37
9.3.5.1.4	Calibration	38
9.3.5.1.5	More Settings Analogue output 4-20mA	38
9.3.6	Flow sensor of type VA 5xx (RS 485 Modbus)	39
9.3.6.1	Settings for Flow sensor VA 5xx	40
9.3.6.1.1	Diameter settings	40
9.3.6.1.2	Gas Constant settings	41
9.3.6.1.3	Definition of the reference conditions	42
9.3.6.1.4	Definition Unit of flow and velocity	42
9.3.6.1.5	Definition consumption counter value and consumption unit	43
9.3.6.2	Settings analogue output 4-20mA of VA 5xx	44
9.3.6.3	Settings Pulse / Alarm output of VA 5xx	45
9.3.6.4	Settings ZeroPoint or Low Flow Cut off for VA 5xx	46
9.3.7	Configuration of analogue sensors	47
9.3.7.1	Type 0 - 1/10/30 Volt and 0/4 - 20 mA	47
9.3.7.2	Type PT100x and KTY81	48
9.3.7.3	Type Pulse (Pulse ration)	49
9.3.7.4	Type No Sensor	51
9.3.8	Typ Modbus	52
9.3.8.1	Auswahl und Aktivierung des Senortypes	52
9.3.8.2	Modbus settings	52
9.3.9	Option Modbus extended channels	56
9.3.9.1	Activation of extended Modbus channel	56
9.3.9.2	Settings of the extended Modbus channels	56
9.3.9.3	Modbus Settings	57
9.3.10	Sensor Settings storing/importing (Custom Sensor)	58
9.3.10.1	Sensor Settings Storing	58
9.3.10.2	Sensor Settings import	59
9.4	Logger settings (data logger)	60

9.5	Device settings	64
9.5.1	Set language.....	64
9.5.2	Date & Time.....	64
9.5.3	Network settings.....	65
9.5.4	ModBus Slave.....	66
9.5.5	Relay settings.....	66
9.5.6	SD-Card.....	66
9.5.7	Update System.....	67
9.5.7.1	Saving System settings.....	67
9.5.7.2	Update FW (Main and channel).....	68
9.5.8	Factory Reset.....	69
9.6	Report settings (optional)	70
9.7	Virtual Channels (optional)	71
9.7.1	Option „Virtual Channels“ activation.....	71
9.7.2	Virtual Channels Settings.....	72
9.7.3	Selection of Sensor-type.....	72
9.7.4	Configuration of each single virtual value.....	74
9.7.4.1	Activation of a single virtual value.....	74
9.7.4.2	Definition of Operands.....	74
9.7.4.3	Definition of Operations.....	75
9.7.4.4	Definition of Unit.....	76
9.7.4.5	Value name, resolution of decimal places and recording of values.....	77
9.7.4.6	Calculation Example „Specific Performance“.....	78
1.1.1	Result in <i>V1c</i> is the complete consumption with <i>V1a</i> + <i>V1b</i> see range “result”.....	79
9.8	Analog Total (optional)	80
9.8.1	Option „Analog Total“ activation.....	80
9.8.1.1	Selection of sensor type.....	81
9.9	Chart	82
9.10	Chart/Real time values	87
9.11	Channels	89
9.12	Real time values	90
9.13	Alarm overview	91
9.14	Further setting options	92
9.14.1	Set backlight.....	92
9.14.2	Calibrate touch-screen.....	93
9.14.3	Cleaning.....	93
9.14.4	System Status.....	93
9.14.5	About DS 500.....	94
9.15	Consumption report with cost settings, export data and webserver	95
9.15.1	Consumption report (optional).....	95
9.15.2	Cost settings (optional).....	97
9.16	Webserver (optional)	98
9.16.1	Option „Webserver“ activation.....	98
9.16.2	Setup the Webserver Admin Password.....	98
9.16.3	Webserver start.....	99
9.16.3.1	Webserver assignment of rights (Administrator).....	100
9.16.3.1.1	Access rights Webserver.....	100
9.16.3.1.2	Webserver Login.....	100
9.16.3.1.3	New users and password definition.....	101
9.16.3.2	Webserver E-Mail Configuration (Administrator).....	102
9.16.3.3	Webserver MailOnAlarm (Administrator & Operator).....	103
9.16.3.4	Webserver Chart (Administrator, Operator & Anwender).....	104
9.16.3.5	Webserver Screen.....	105
9.16.3.6	Webserver Actuals.....	106
9.16.3.7	Webserver Status.....	106

9.17	Import / Export	107
9.17.1	Export Logger data	107
9.17.2	Screenshots export	108
9.17.3	Export System Settings	109
9.17.4	Export Report.....	109
9.17.5	Import system settings	110
10	Screenshot function	111
10.1	Screenshot saving	111
11	Cleaning	112

1 Safety instructions

1.1 General



Please check whether this manual corresponds with the device type.

Please attend to all notes indicated in this instruction manual. It contains essential information which has to be followed during installation, operation and maintenance. Therefore this instruction manual has to be read categorically by the technician as well as by the responsible user/qualified personnel before installation, initiation and maintenance.

This instruction manual has to be available at any time at the operation site of the DS 500.

Regional and national regulations respectively, have to be observed in addition to this instruction manual if necessary.

In case of any obscurities or questions with regard to this manual or the instrument please contact CS Instruments GmbH.



Warning!

Inadmissible operating parameters!

Undercutting and exceeding respectively of limit values may cause danger to persons and material and may lead to functional and operational disturbances.

Measures:

- Make sure that the DS 500 is only operated within the admissible limit values indicated on the type label.
- Strict observance of the performance data of the DS 500 in connection with the application.
- Do not exceed the admissible storage and transportation temperature.

Further safety instructions:

- Attention should also be paid to the applicable national regulations and safety instructions during installation and operation.
- The DS 500 is not allowed to be used in explosive areas.

Additional remarks:

- Do not overheat the instrument!
- Change of battery or SD-Card are only allowed to be carried out by authorized qualified personnel. and in strainless state!



Attention!

Malfunctions at the DS 500!

Faulty installation and insufficient maintenance may lead to malfunctions of the DS 500 which may affect the measuring results and which may lead to misinterpretations.

1.1 Installation

**Warning!****Supply voltage!**

Contact with supply voltage carrying non-insulated parts may cause an electric shock with injury and death.

Measures:

- Note all applicable regulations for electrical installations (e.g. VDE 0100)!
- **Carry out maintenance only in strain less state!**
- All electric works are only allowed to be carried out by authorized qualified personnel.

**Danger!****Missing earth connection!**

When the earth connection (protective earth) is missing, there is the risk in the event of malfunction, that contactable, conductive components may carry supply voltage. Touching of such parts leads to an electric shock with injuries and death.

It is imperative to connect the plant to earth or to connect the protective conductor according to the regulations.

Do not use plug adapters at the power plug.

Have the power plug replaced by qualified skilled persons, if required.

The plug of the power supply cord is used as a separator. This separator must be clearly recognizable and easily accessible by the user. A plug connector with a CEE7/7 system is necessary.

All the electrical lines carrying supply voltage or another voltage that is dangerous in the case of contact (power supply cord, alarm and indicator relays), must additionally be equipped with double or reinforced insulation (EN 61010-1). This can be ensured by using plastic-sheathed cables, a second insulation (e.g. flexible insulating tubing), or correspondingly suitable lines with reinforced insulation.

The connecting cables can be equipped, for example, with flexible insulating tubing.

The additional flexible insulating tubing must withstand the electrical and mechanical stresses which can occur during the intended use (see EN 61010-1, Clause 6.7.2.2.1).

2 Application area

Our long-term hands-on experience in measurement and control technology was implemented in the new DS 500.

From recording of the measured data, automatic sensor identification, indication on a big colour screen, alerting, storage up to remote read-out via web server, all that is possible with DS 500. By means of the CS-Soft, software alarms can be sent via SMS or e-mail.

On the big 7" colour screen with touch panel all information is available at a glance. The operation is very easy. All measured values, measured curves and threshold exceedings are indicated. The progression of the curve, since the beginning of the measurement, can be viewed by an easy slide of the finger.

Daily, weekly and monthly reports, with costs in € and counter reading in m³, for each consumption sensor are completing the sophisticated system concept.

The huge difference to ordinary paperless chart recorders reveals in the easy initiation as well as in the evaluation of the measured data. All sensors are identified directly and powered by DS 500. Everything is matched and tuned.

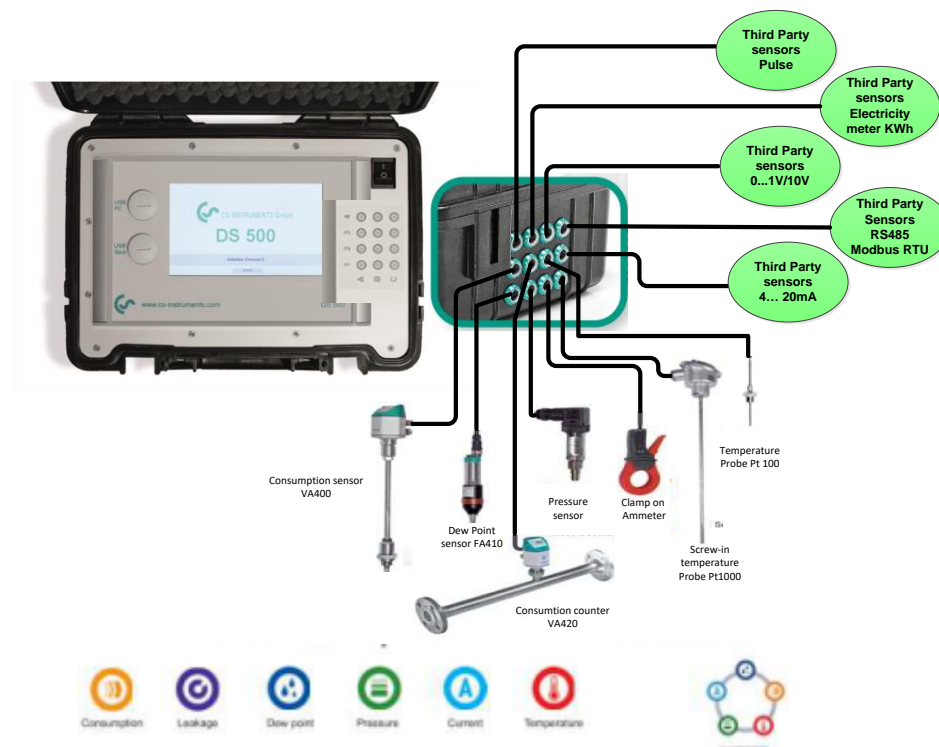

Versatile:

Up to 12 sensors, incl. all CS sensors (consumption, dewpoint, pressure, current, KTY, PT 100, PT 1000) are identified automatically by DS 500. Optional analogue sensors (0/4 - 20 mA, 0 - 1/10/30 V, pulse) can be configured easily and quickly. Digital sensors can be connected via RS 485, Modbus RTU and SDI.

Flexible:

Network-compatible and worldwide remote data transmission via Ethernet, integrated web server.

Remark:

Alarm relays are not accessible at DS 500 mobile only at DS500 stationary.

3 Intended use

The DS 500 data logger serves for the stationary measured data acquisition and storage of analogue and digital input signals.

The DS 500 data logger is exclusively designed and constructed for the proper application purpose that is described herein and must only be used correspondingly.

A check in order to ascertain whether or not the device is suitable for the chosen employment must be carried out by the user. It must be ensured that the medium is compatible with the components which come into contact with it. The technical data listed in the data sheet are binding.

Improper handling or operation outside the technical specifications is impermissible. Claims of any kind on the basis of improper use are excluded.

4 Technical data DS 500

Dimensions of housing	360x270x150 mm
Connections	4/8/12 x PG 12 for sensors and supply 1 x RJ 45 Ethernet connection
Weight	4.5 kg
Material	impact resistant HDPE/HWU –plastic (ABS), front screen polyester.
Sensor inputs	4/8/12 sensor inputs for analogue and digital sensors freely allocable. Digital CS sensors for dew point and consumption with SDI interface FA/VA 400 Series. Digital third-party sensors RS 485/Modbus RTU, other bus systems realizable on request. Analogue CS sensors for pressure, temperature, clamp-on ammeters preconfigured. Analogue third-party sensors 0/4 – 20 mA, 0 - 1/10/30 V, pulse, Pt100/Pt1000, KTY.
Power supply for sensors	Output voltage: 24 VDC \pm 10% galvanically isolated Output current: 130 mA by continuous operation, peak 180mA Maximum output current over all channels with - one power supply: 400mA - two power supplies: 1Ampere Maximum power input with - one power supply: 25VA - two power supplies: 50VA
Interfaces	USB stick, USB cable, Ethernet/RS 485 Modbus RTU/TCP, SDI other bus systems on request, web server optionally
Outputs	Analogue output, pulse in case of sensors with own signal output looped, like e. g. VA/FA Series.
Memory card	Memory size 2 GB SD memory card standard, optionally up to 4 GB
Power supply	100 - 240 VAC/50 - 60 Hz, special version 24 VDC
Battery ¹⁾	CR 2032
Colour screen	7" touch panel TFT transmissive, graphics, curves, statistics
Accuracy	See sensor specifications
Operating temperature	0 - 50 °C
Storage temperature	-20 - 70 °C
Optionally	Web server
Optionally	Quick measurement with 10 ms sampling rate for analogue sensors, Max/Min indication per second.
Optionally	Option "consumption report" statistics, daily/weekly/monthly report.

¹⁾ Lithium manganese dioxide Battery, Panasonic CR2032 / 3 V / 225 mAh

5 Input signal

Input signal		
Current signal (0 – 20 mA / 4 – 20 mA) internal or external power supply	Measuring range	0 – 20 mA / 4 – 20 mA
	Resolution	0,0001 mA
	Accuracy	$\pm 0,03 \text{ mA} \pm 0,05 \%$
	Input resistance	50 Ω
Voltage signal (0 - 1V)	Measuring range	0 - 1 V
	Resolution	0,05 mV
	Accuracy	$\pm 0,2 \text{ mV} \pm 0,05 \%$
	Input resistance	100 k Ω
Voltage signal (0 - 10 V / 30 V)	Measuring range	0 - 10 V/30 V
	Resolution	0,5 mV
	Accuracy	$\pm 2 \text{ mV} \pm 0,05 \%$
	Input resistance	1 M Ω
RTD Pt100	Measuring range	-200 - 850 °C
	Resolution	0,1 °C
	Accuracy	$\pm 0,2 \text{ °C}$ at -100 - 400 °C $\pm 0,3 \text{ °C}$ (further range)
RTD Pt1000	Measuring range	-200 - 850 °C
	Resolution	0,1 °C
	Accuracy	$\pm 0,2 \text{ °C}$ at -100 - 400 °C $\pm 0,3 \text{ °C}$ (further range)
Pulse	Measuring range	minimal pulse length 100 μs frequency 0 - 1 kHz max. 30 VDC

6 Cable cross-section

6.1 Power supply 100 - 240 VAC, 50 - 60 Hz, special version 24 VDC:

Cable cross section power supply: 0,75 mm²

6.2 Sensor circuit points/Output signal:

ODU Medi Snap 8 pin

AWG16 – AWG28, cable cross-sections: 0,14 - 1,5 mm²

7 Connection diagrams of the different sensor types

7.1 Connector pin assignment for all sensors A.1 – A.4, B.1 – B.4, C.1 – C.4

The interface connector to be used is a ODU Medi Snap 8 pin – Reference: K11M07-P08LFD0-6550

Available connection cables at CS-Instruments are:

ODU with Open ends: Order no 0553 0501, cable length: 5 m.
Order no 0553 0502, cable length: 10 m.

ODU with M12 Connector: Order no 0553 0503, cable length: 5 m.

Extention cable (ODU/ODU): Order no 0553 0504, cable length: 10 m.

Connection scheme:

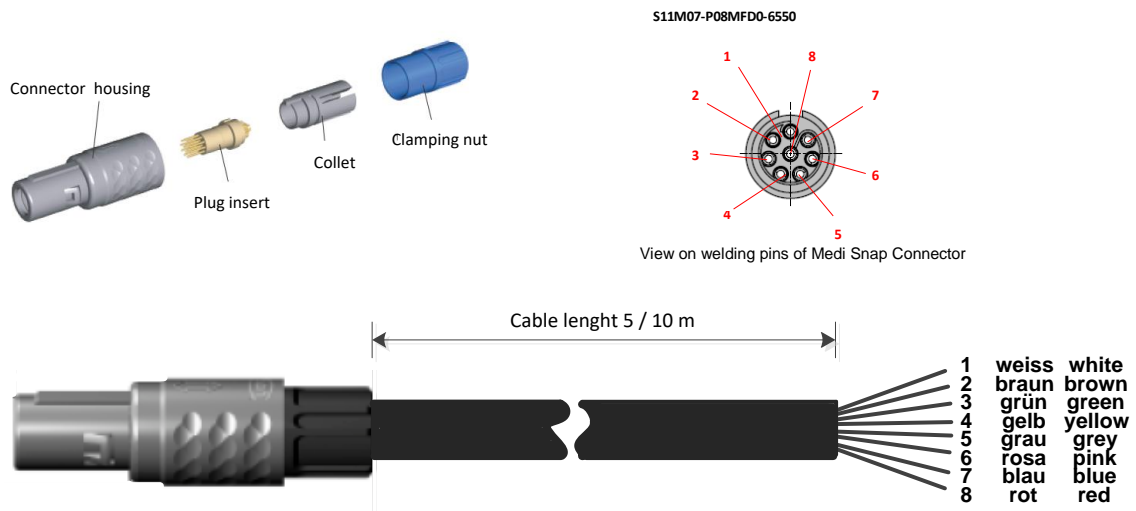

<p>A.1 – A.4 B.1 – B.4 C.1 – C.4</p> <table border="1" style="width: 100%; border-collapse: collapse;"> <tr><td style="text-align: center;">+ RS485</td><td style="text-align: center;">● 1</td><td style="text-align: center;">White</td></tr> <tr><td style="text-align: center;">- RS485</td><td style="text-align: center;">● 2</td><td style="text-align: center;">Brown</td></tr> <tr><td style="text-align: center;">SDI</td><td style="text-align: center;">● 3</td><td style="text-align: center;">Green</td></tr> <tr><td style="text-align: center;">Analog IN +</td><td style="text-align: center;">● 4</td><td style="text-align: center;">Yellow</td></tr> <tr><td style="text-align: center;">Analog IN -</td><td style="text-align: center;">● 5</td><td style="text-align: center;">Grey</td></tr> <tr><td style="text-align: center;">I (500µA)</td><td style="text-align: center;">● 6</td><td style="text-align: center;">Pink</td></tr> <tr><td style="text-align: center;">+VB 24Vdc</td><td style="text-align: center;">● 7</td><td style="text-align: center;">Blue</td></tr> <tr><td style="text-align: center;">-VB GND</td><td style="text-align: center;">● 8</td><td style="text-align: center;">Red</td></tr> </table>	+ RS485	● 1	White	- RS485	● 2	Brown	SDI	● 3	Green	Analog IN +	● 4	Yellow	Analog IN -	● 5	Grey	I (500µA)	● 6	Pink	+VB 24Vdc	● 7	Blue	-VB GND	● 8	Red	<p>+ RS485</p> <p>- RS485</p> <p>SDI (CS-internal data transfer for all dew point and consumption sensors)</p> <p>ANALOGUE IN + (current signal and voltage signal)</p> <p>ANALOGUE IN - (current signal and voltage signal)</p> <p>CURRENT SOURCE 500 µA</p> <p>+VB, 24V DC sensor power supply</p> <p>- VB-, GND sensor</p>
+ RS485	● 1	White																							
- RS485	● 2	Brown																							
SDI	● 3	Green																							
Analog IN +	● 4	Yellow																							
Analog IN -	● 5	Grey																							
I (500µA)	● 6	Pink																							
+VB 24Vdc	● 7	Blue																							
-VB GND	● 8	Red																							

7.2 Connection diagrams

The following connection diagrams in Chapter 7 apply to A.1 to C.4!

FA serial: dew point sensors from CS Instruments

VA serial: consumption sensors from CS Instruments

7.2.1 Connection CS dew point sensors, serial FA 415/FA 300

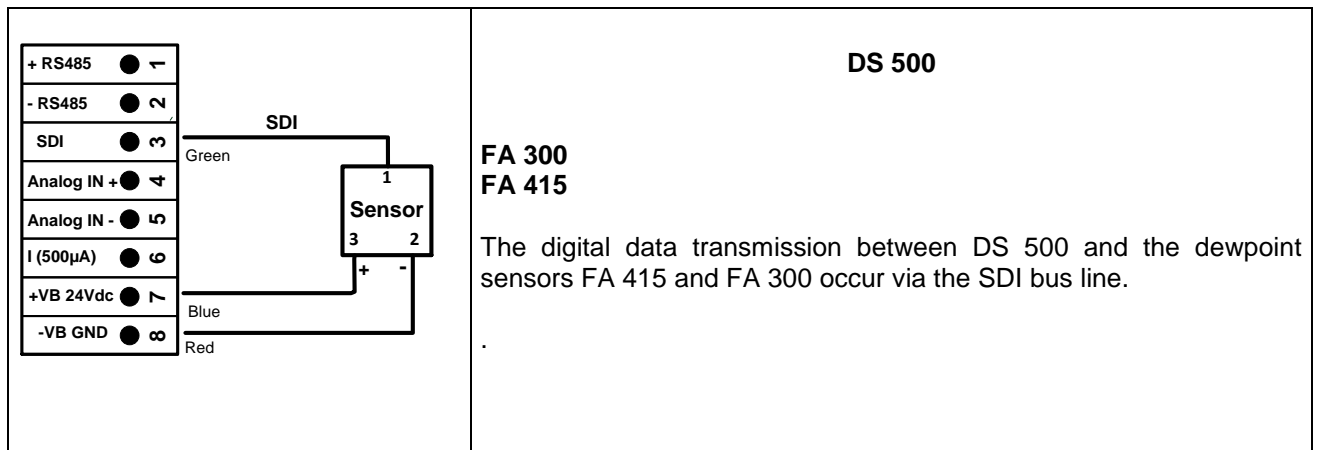

7.2.2 Connection for dew point- and consumption sensors, serial FA/VA 400

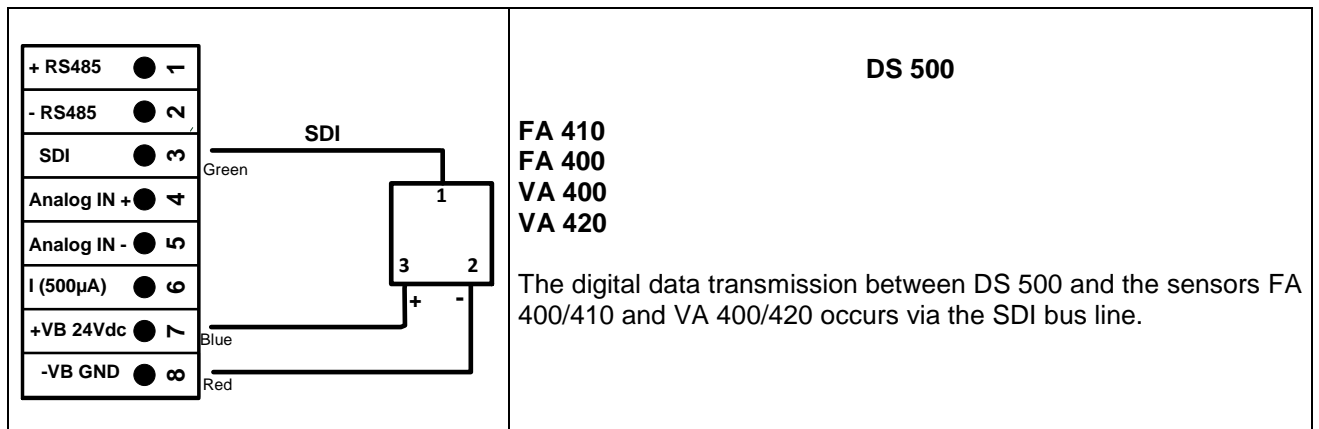

7.2.3 Connection for dew point- and consumption sensors, serial FA/VA 5xx

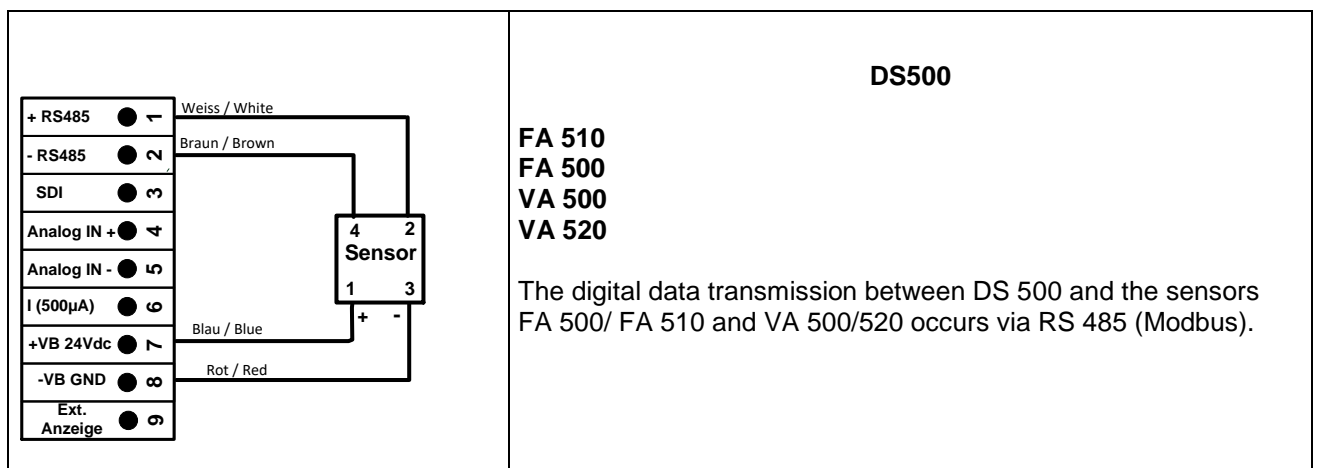

7.2.4 Connection pulse sensor

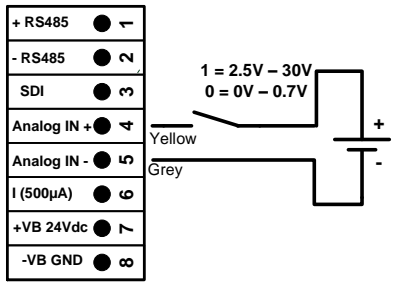
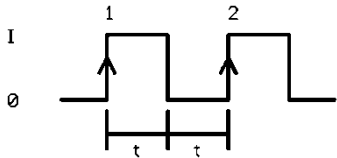
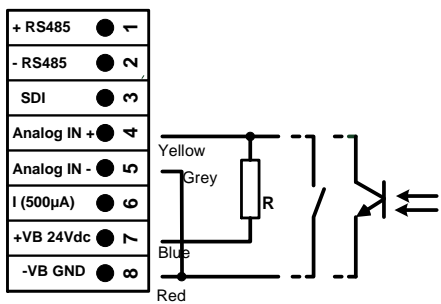
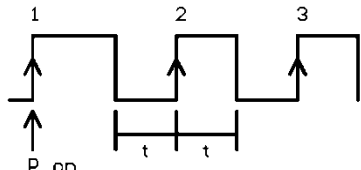
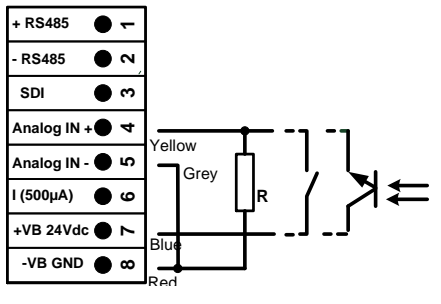
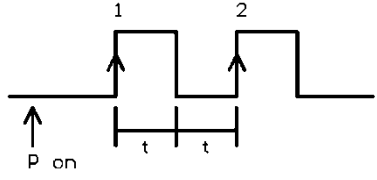
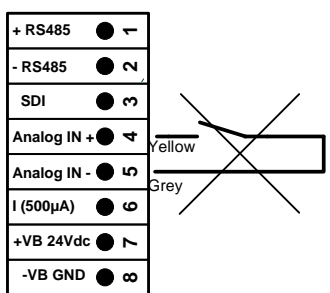
		<p>signal level 0: low = 0 – 0,7 VDC</p> <p>signal level 1: high = 2,5 – 30 VDC</p> <p>t = 400 µs</p> <p>max. frequency (duty cycle 1:1) = 1000 Hz</p> <p>input resistance: min. 100 kilo ohm</p>
		<p>external essential R = 4K7</p> <p>Attention: The DS 500 is counting a consumption unit, by switching „power on“.</p>
		<p>external essential R = 4K7</p>
		<p>It won't work!</p>

7.2.5 Analogue two-, three-, and four-wire current signal

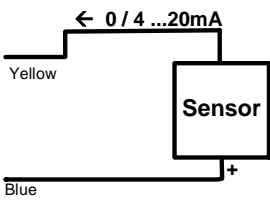
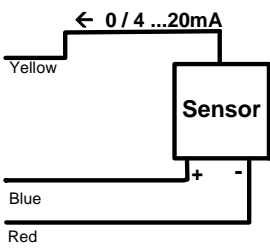
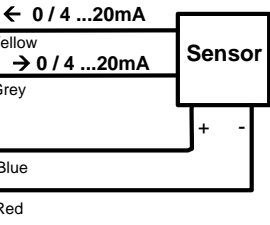
Sensors with 4 - 20 mA output in 2-wire technology																									
<table border="1" style="width: 100%; border-collapse: collapse;"> <tr><td>+ RS485</td><td>●</td><td>1</td></tr> <tr><td>- RS485</td><td>●</td><td>2</td></tr> <tr><td>SDI</td><td>●</td><td>3</td></tr> <tr><td>Analog IN +</td><td>●</td><td>4</td></tr> <tr><td>Analog IN -</td><td>●</td><td>5</td></tr> <tr><td>I (500µA)</td><td>●</td><td>6</td></tr> <tr><td>+VB 24Vdc</td><td>●</td><td>7</td></tr> <tr><td>-VB GND</td><td>●</td><td>8</td></tr> </table> 	+ RS485	●	1	- RS485	●	2	SDI	●	3	Analog IN +	●	4	Analog IN -	●	5	I (500µA)	●	6	+VB 24Vdc	●	7	-VB GND	●	8	DS 500
+ RS485	●	1																							
- RS485	●	2																							
SDI	●	3																							
Analog IN +	●	4																							
Analog IN -	●	5																							
I (500µA)	●	6																							
+VB 24Vdc	●	7																							
-VB GND	●	8																							
Sensors with 4 - 20 mA output in 3-wire technology																									
<table border="1" style="width: 100%; border-collapse: collapse;"> <tr><td>+ RS485</td><td>●</td><td>1</td></tr> <tr><td>- RS485</td><td>●</td><td>2</td></tr> <tr><td>SDI</td><td>●</td><td>3</td></tr> <tr><td>Analog IN +</td><td>●</td><td>4</td></tr> <tr><td>Analog IN -</td><td>●</td><td>5</td></tr> <tr><td>I (500µA)</td><td>●</td><td>6</td></tr> <tr><td>+VB 24Vdc</td><td>●</td><td>7</td></tr> <tr><td>-VB GND</td><td>●</td><td>8</td></tr> </table> 	+ RS485	●	1	- RS485	●	2	SDI	●	3	Analog IN +	●	4	Analog IN -	●	5	I (500µA)	●	6	+VB 24Vdc	●	7	-VB GND	●	8	DS500
+ RS485	●	1																							
- RS485	●	2																							
SDI	●	3																							
Analog IN +	●	4																							
Analog IN -	●	5																							
I (500µA)	●	6																							
+VB 24Vdc	●	7																							
-VB GND	●	8																							
Sensors with 4 - 20 mA output in 4-wire technology																									
<table border="1" style="width: 100%; border-collapse: collapse;"> <tr><td>+ RS485</td><td>●</td><td>1</td></tr> <tr><td>- RS485</td><td>●</td><td>2</td></tr> <tr><td>SDI</td><td>●</td><td>3</td></tr> <tr><td>Analog IN +</td><td>●</td><td>4</td></tr> <tr><td>Analog IN -</td><td>●</td><td>5</td></tr> <tr><td>I (500µA)</td><td>●</td><td>6</td></tr> <tr><td>+VB 24Vdc</td><td>●</td><td>7</td></tr> <tr><td>-VB GND</td><td>●</td><td>8</td></tr> </table> 	+ RS485	●	1	- RS485	●	2	SDI	●	3	Analog IN +	●	4	Analog IN -	●	5	I (500µA)	●	6	+VB 24Vdc	●	7	-VB GND	●	8	DS500
+ RS485	●	1																							
- RS485	●	2																							
SDI	●	3																							
Analog IN +	●	4																							
Analog IN -	●	5																							
I (500µA)	●	6																							
+VB 24Vdc	●	7																							
-VB GND	●	8																							

7.2.6 Three- and four-wire power supply 0 - 1/10/30 VDC

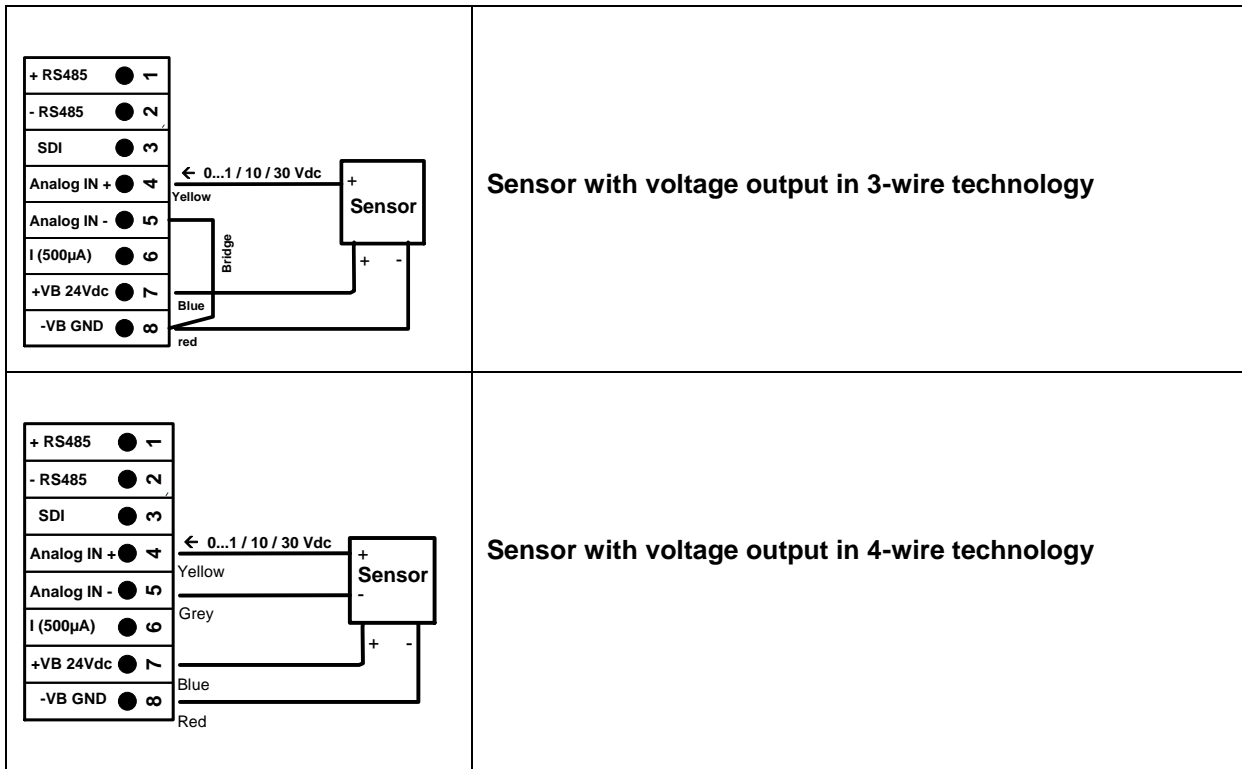

7.2.7 Two-, three-, and four-wire connector pin assignments for PT100/PT1000/KTY81

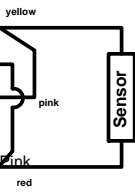
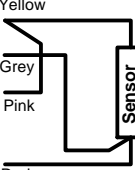
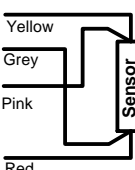
<table border="1"> <tr><td>+ RS485</td><td>1</td></tr> <tr><td>- RS485</td><td>2</td></tr> <tr><td>SDI</td><td>3</td></tr> <tr><td>Analog IN +</td><td>4</td></tr> <tr><td>Analog IN -</td><td>5</td></tr> <tr><td>I (500µA)</td><td>6</td></tr> <tr><td>+VB 24Vdc</td><td>7</td></tr> <tr><td>-VB GND</td><td>8</td></tr> </table> 	+ RS485	1	- RS485	2	SDI	3	Analog IN +	4	Analog IN -	5	I (500µA)	6	+VB 24Vdc	7	-VB GND	8	<p>2-wire PT100/PT1000/KTY81</p>								
+ RS485	1																								
- RS485	2																								
SDI	3																								
Analog IN +	4																								
Analog IN -	5																								
I (500µA)	6																								
+VB 24Vdc	7																								
-VB GND	8																								
<table border="1"> <tr><td>+ RS485</td><td>1</td><td>Red</td></tr> <tr><td>- RS485</td><td>2</td><td></td></tr> <tr><td>SDI</td><td>3</td><td></td></tr> <tr><td>Analog IN +</td><td>4</td><td>Yellow</td></tr> <tr><td>Analog IN -</td><td>5</td><td>Grey</td></tr> <tr><td>I (500µA)</td><td>6</td><td>Pink</td></tr> <tr><td>+VB 24Vdc</td><td>7</td><td></td></tr> <tr><td>-VB GND</td><td>8</td><td>Red</td></tr> </table> 	+ RS485	1	Red	- RS485	2		SDI	3		Analog IN +	4	Yellow	Analog IN -	5	Grey	I (500µA)	6	Pink	+VB 24Vdc	7		-VB GND	8	Red	<p>3-wire PT100/PT1000/KTY81</p>
+ RS485	1	Red																							
- RS485	2																								
SDI	3																								
Analog IN +	4	Yellow																							
Analog IN -	5	Grey																							
I (500µA)	6	Pink																							
+VB 24Vdc	7																								
-VB GND	8	Red																							
<table border="1"> <tr><td>+ RS485</td><td>1</td><td></td></tr> <tr><td>- RS485</td><td>2</td><td></td></tr> <tr><td>SDI</td><td>3</td><td></td></tr> <tr><td>Analog IN +</td><td>4</td><td>Yellow</td></tr> <tr><td>Analog IN -</td><td>5</td><td>Grey</td></tr> <tr><td>I (500µA)</td><td>6</td><td>Pink</td></tr> <tr><td>+VB 24Vdc</td><td>7</td><td></td></tr> <tr><td>-VB GND</td><td>8</td><td>Red</td></tr> </table> 	+ RS485	1		- RS485	2		SDI	3		Analog IN +	4	Yellow	Analog IN -	5	Grey	I (500µA)	6	Pink	+VB 24Vdc	7		-VB GND	8	Red	<p>4-wire PT100/1000/KTY81</p>
+ RS485	1																								
- RS485	2																								
SDI	3																								
Analog IN +	4	Yellow																							
Analog IN -	5	Grey																							
I (500µA)	6	Pink																							
+VB 24Vdc	7																								
-VB GND	8	Red																							

7.3 Connection with RS485

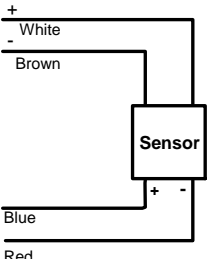
<table border="1"> <tr><td>+ RS485</td><td>1</td></tr> <tr><td>- RS485</td><td>2</td></tr> <tr><td>SDI</td><td>3</td></tr> <tr><td>Analog IN +</td><td>4</td></tr> <tr><td>Analog IN -</td><td>5</td></tr> <tr><td>I (500µA)</td><td>6</td></tr> <tr><td>+VB 24Vdc</td><td>7</td></tr> <tr><td>-VB GND</td><td>8</td></tr> </table> 	+ RS485	1	- RS485	2	SDI	3	Analog IN +	4	Analog IN -	5	I (500µA)	6	+VB 24Vdc	7	-VB GND	8	<p>Sensor with RS485 interface</p>
+ RS485	1																
- RS485	2																
SDI	3																
Analog IN +	4																
Analog IN -	5																
I (500µA)	6																
+VB 24Vdc	7																
-VB GND	8																

8 Connect the DS 500 with a PC

Important:

The IP addresses of PC and DS 500 must be statically assigned (DHCP off) and have to be in the same network.

If the IP-address of the DS 500 has changed, you have to reboot!

Remark:

IP-address of the DS 500: See chapter, [9.5.3 Network settings](#)

Reboot the DS 500: See chapter, [9.5.7 Factory Reset](#)

The DS 500 can be connected with the PC by a crossover cable, which has a RJ45 plug on each side, or an Ethernet cable with a crossover adapter.

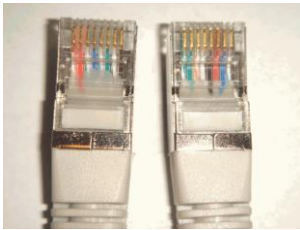

Crossover cable with RJ45-plug



Crossover-Adapter

After connecting the DS 500 via a suitable cable to the PC, you can make graphical and tabular data evaluations with the CS Soft Basic software.

Windows PC's, network settings:

Windows 7:

Start → Control Panel → Network and Sharing Center → adapter → Networking → Properties → Internet Protocol Version 4 (TCP/IPv4) → Use the Following IP address → enter IP address and Subnet mask

After this: OK → OK → Close

Windows Vista:

Start → Control Panel → Network and Sharing Center → Network connection → Networking → Properties → Internet Protocol Version 4 (TCP/IPv4) → Use the Following IP address → enter IP address and Subnet mask

After this: OK → OK → Close

Windows XP:

Start → Properties → Control Panel → Network connection → Networking → Properties → Internet Protocol Version 4 (TCP/IPv4) → Use the Following IP address → enter IP address and Subnet mask

After this: OK → OK → Close

9 Operation DS 500

The operation is largely self-explanatory and menu-driven via the touch panel. The selection of the respective menu items occur via short "tapping" with the finger or a soft round pen.

**Attention: Please use no pens or other objects with sharp edges!
The foil can be damaged!**

After sensors are connected, they also have to be configured.

Inputs or changes can be made with all white deposit fields. The measured values can be represented as a curve or values.

Words in **green font** refer mainly to the pictures in the section of the chapter, but also on important menu paths or menu items that are related to are in **green font**.

The menu navigation is generally in a **green font**!

The table of contents and chapter references in **blue font** contain links to the respective chapter title.

9.1 Main menu (Home)

From the main menu, you can reach every available item.

9.1.1 Initialization



After switching on the DS 500 all channels are initialized and the main menu will appear.

Attention:
For the first initiation, there may be no channels preset!

Please see chapter **9.3.2 Sensor settings**, then select appropriate configurations and set!

9.1.2 Main menu after initialization

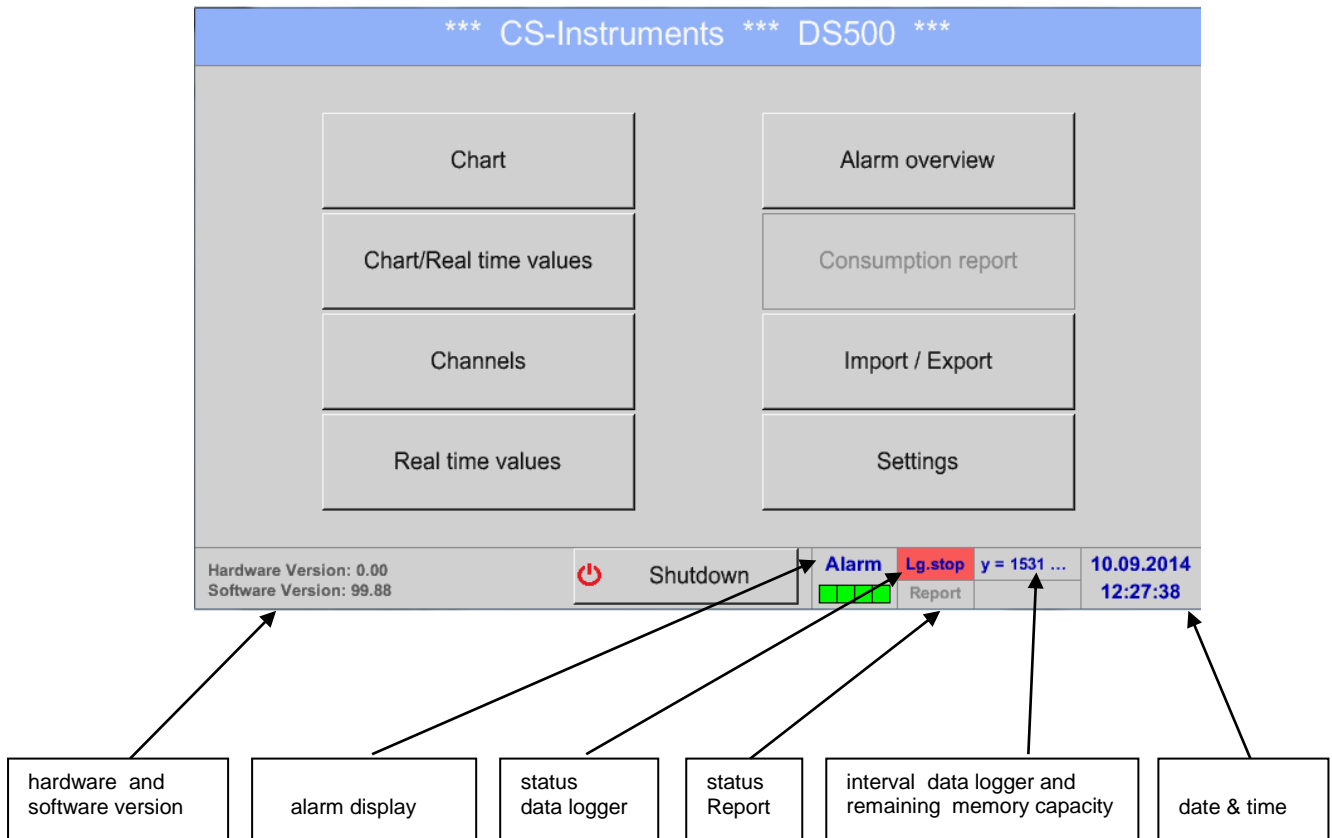

Important:

Before the first sensor setting is made, the language and time should be set!

Remark:

Chapter [9.5.1 Set language](#)

([Main menu](#) → [Settings](#) → [Device Settings](#) → [Set Language](#))

Chapter [9.5.2 Date & Time](#)

([Main menu](#) → [Settings](#) → [Device Settings](#) → [Date & Time](#))

9.2 Shutdown



Important: In case the DS500 has to be set into a strainless state, e.g. by turn off the main switch after finishing the measurements, it needs a defined termination / storage of the recorded data by a proper shutdown

[Main menu](#) → [Shutdown](#)

This process must always be confirmed by entering the password.

9.3 Settings

The settings are all protected by a password!

Settings or changes are generally confirmed with **OK!**

Remark:

If you go back to main menu and then again one of the setting menus is called, you must enter the password again.

Main menu → Settings

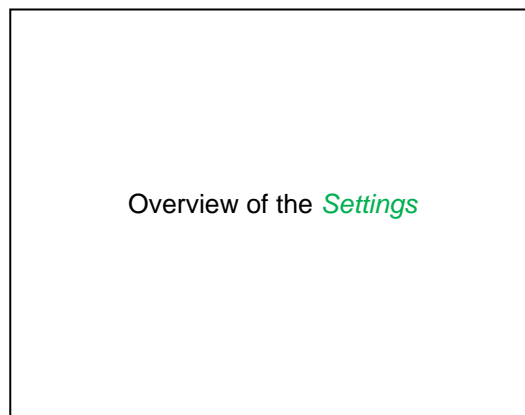
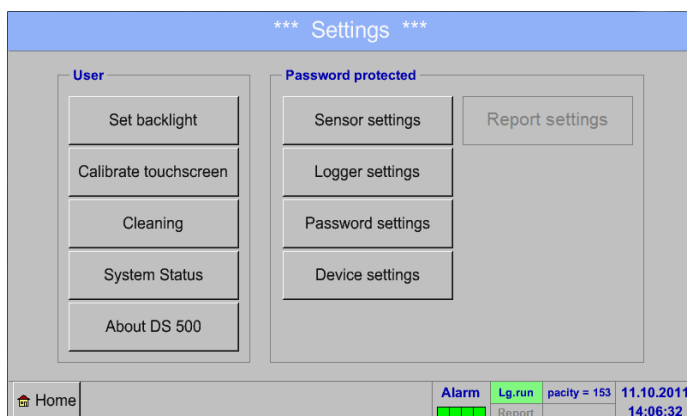

The optional *Report settings* and the appendant *Cost settings*, you will find in chapter 19.15 *Report settings (optional)* and 9.15.2 *Cost Settings (optional)*. The out of it resultant summary table, you can see in the *Consumption report* in chapter 9.15.1 *Consumption report (optional)*.

9.3.1 Password settings

Main menu → Settings → Password settings

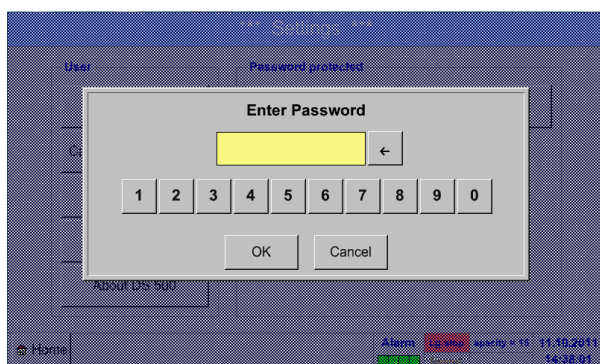

Factory settings for password at the time of delivery: 0000 (4 times zero).

If required, the password can be changed in the *Password settings*.

The new password must be entered two times in a row and in each case confirmed with **OK**.



If an incorrect password is entered there appears *Enter password* or *New password repeat* in red font.

If you can't remember the password, please use Master password in order to enter a new password.

Remark:

The master password is supplied together with the instrument's documentation.

9.3.2 Sensor settings

Important:

Sensors from CS Instruments are generally pre-configured and can be connected directly to a free sensor channel!

Main menu → Settings → Sensor settings

A1	A2	A3	A4
unused	unused	unused	unused
B1	B2	B3	B4
unused	unused	unused	unused
C1	C2	C3	C4
unused	unused	unused	unused
Back	Alarm Lg.stop pacity = 153 11.10.2011 Report 14:06:32		

An overview of the available channels appears after entering the password. Depending on the version, 4, 8 or 12 channels.

Remark:
Usually no channels preset!

Remark:

Depending on the DS 500:

- No extension board → 4 channels/setups
- One extension board → 8 channels/setups
- Two extension boards → 12 channels/setups

9.3.2.1 Choice of the sensor type (For example type CS-Digital sensor)

Main menu → Settings → Sensor settings → A1

*** Channel A1 ***

Name

Type

No Sensor defined

Back

If still no sensor has been configured, the *Type No Sensor* appears.

By pushing the description field *Type No Sensor* the list of sensor types appears (see next step).

Main menu → Settings → Sensor settings → A1 → Type description field → CS-Digital

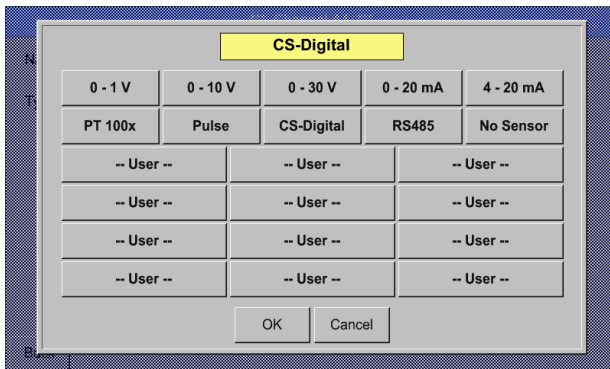

Now the *Type CS-Digital* is elected for the VA/FA 400 series.

Main menu → Settings → Sensor settings → A1 → diameter description field

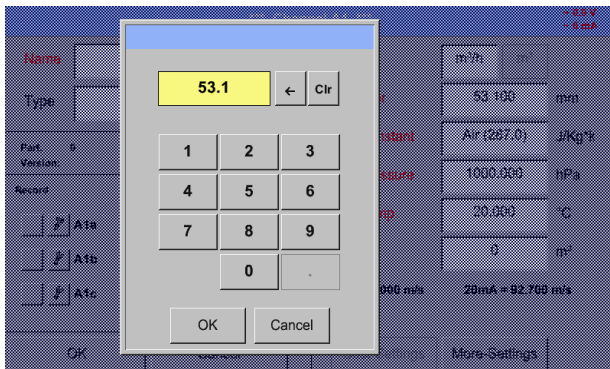

Important:

The *inner diameter* of flow tube can be entered here, if this was not automatically correctly set.

Important:

The *inner diameter* should be entered as precisely as possible, because otherwise the measurement results are not correct!

There is no uniform standard for the tube *inner diameter*!
(Please, inquire at the manufacturer or measure by your own !)

Main menu → Settings → Sensor settings → A1

Now you can enter a *Name* and the *counter* status of the old sensor, if the sensor was changed.

This completes the configuration of the sensor.

After label and confirm with *OK*.

Remark:

After confirm with *OK*, the font is black again and the values and settings are accepted.

Attention:

Reference temperature and reference pressure (factory setting 20 °C, 1000 hPa):
All volume flow values (m³/h) and consumption values indicated in the display are related to 20 °C, 1000 hPa (according to ISO 1217 intake condition)
0 °C and 1013 hPa (= standard cubic meter) can also be entered as a reference.
Do not enter the operation pressure or the operation temperature under reference conditions!

9.3.2.2 Label and setting the description fields

Main menu → Settings → Sensor settings → A1 → Text filed Name

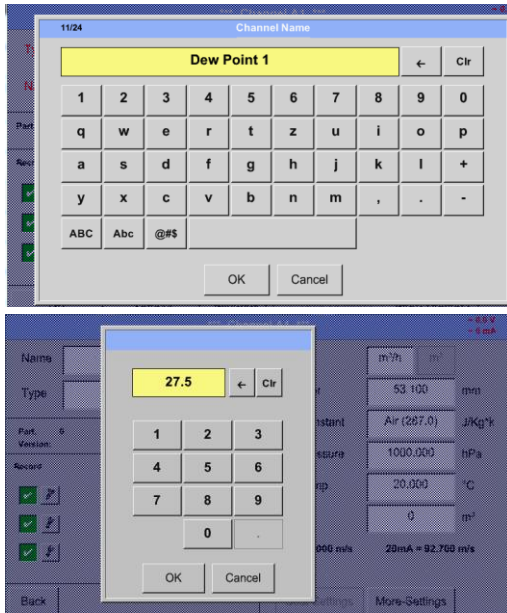

In the case of text description field, a menu opens with the corresponding selection

- For name fields, a keyboard as you can see left side.
- For value fields a keypad as you can see left
- In case of a selection field a corresponding menu with possible entries will be displayed. See therefore chapter Sensor settings.

For the sensor name it is possible to enter a name with up to 24 characters.
For values names are max. 10 characters and for the short name max. 3 characters possible.

9.3.2.3 Name the measurement data and define the decimal places

Remark:

The *Resolution* of the decimal places, the *Short Name* and *Value Name* are found under the **Tool button!**



Tool button:

Main menu → Settings → Sensor settings → A1 → Tool Button

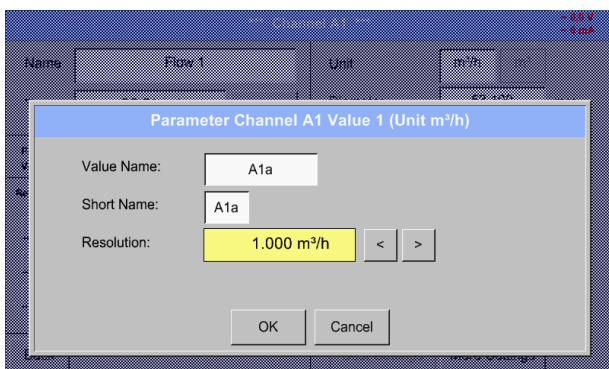

For the recorded *Value* there can be entered a *Name* with 10 characters and later in menu item *Graphics/Real time values* it is easier to identify it.

Otherwise the *Name* is, for example, *A1a*. The channel name is *A1* and *a* is the first measurement data at the channel, the Second *b* and the Third *c*. The *Resolution* of the decimal places is simply adjustable by pushing right and left (0 to 5 decimal places).

See also chapter 9.3.2.2 Label and setting the description fields

Important:

In the menu items *Main → Settings → Sensor settings* and *Main → Real time values*, the *Value Name* displayed only by the DS 500 standard version with 4 channels!

The *Short Name* is used only in these two menu items, by the DS 500 versions with one or two extension boards (8 or 12 channels).

9.3.2.4 Recording measurement data

Main menu → Settings → Sensor settings → A1 → Record Button

*** Channel A1 *** - 0.0 V
- 0 mA

Name	Flow 1	Unit	m ³ /h <input type="checkbox"/> m ³
Type	CS-Digital <input type="button" value="Store"/>	Diameter	53.100 mm
Part: 0	Serial: 1	Gas Constant	Air (287.0) J/Kg*k
Version:	Max Velocity 92.700 m/s	Ref. Pressure	1000.000 hPa
Record		Ref. Temp.	20.000 °C
<input checked="" type="checkbox"/> A1a	1165.2 m ³ /h	counter	27366 m ³
<input checked="" type="checkbox"/> A1b	27366 m ³	4mA = 0.000 m/s	20mA = 92.700 m/s
<input checked="" type="checkbox"/> A1c	180.0 m/s		

Use the *Record* buttons to select the measurement data that will be stored by **activated data logger**.

Attention:

Before the selected measurement data are recorded, the data logger must be activated after the settings (See chapter [9.4 Logger settings \(data logger\)](#))

9.3.2.5 Alarm settings

Remark:

For DS500 mobile only the alarm-warnings on the display are available, alarm-relays are not accessible.

Main menu → Settings → Sensor settings → A1 → Alarm Button

By pushing an alarm button, the following window appears:

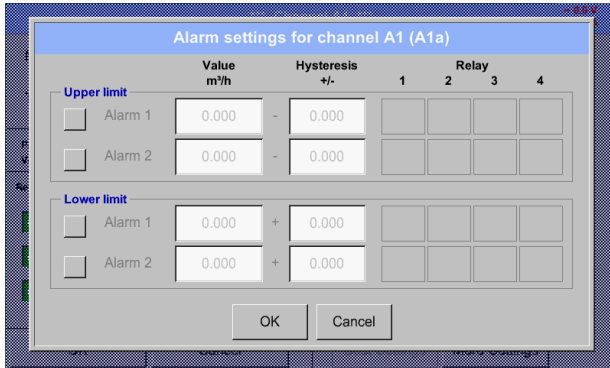

In the alarm settings an *Alarm 1* and *Alarm 2* incl. *Hysteresis* can be entered for each channel.

In the menu *Alarm overview* (can be reached from the main menu), the alarm settings are clearly represented.

Main menu → Settings → Sensor settings → A1 → Alarm Button → Alarm 1 and 2 Buttons → Relais Buttons

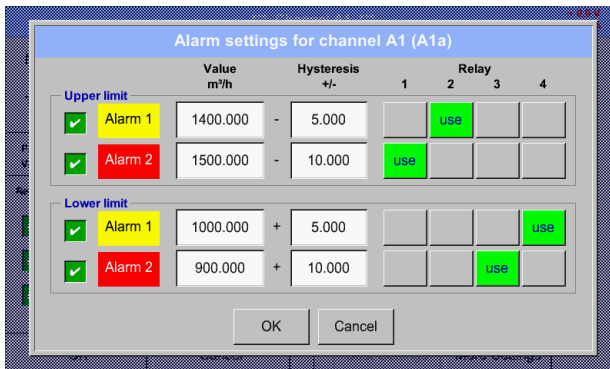

E.g. set the *Alarm 1* to relay 2 and relay 4 and the *Alarm 2* to relay 1 and relay 3.

Remark: It can be set one of any relay as *Alarm 1* or *Alarm 2* thirty-two times.

Main menu → Settings → Sensor settings → A1 → Alarm-Button → Relay-buttons

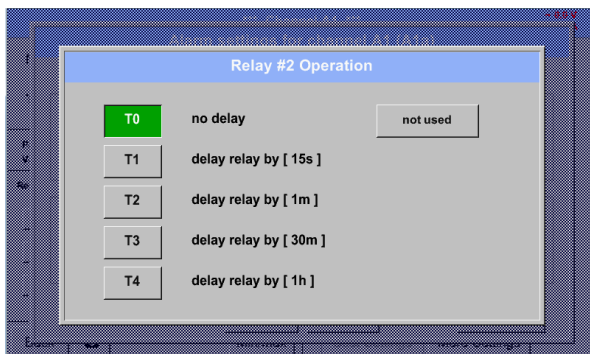

It is possible to select from 5 different delays.

T0 is preset to no delay.

The delays (T1 to T4) are free definable but are common valid for all relays.

Main menu → Settings → Sensor settings → A1 → Alarm-Button → Setup Delay

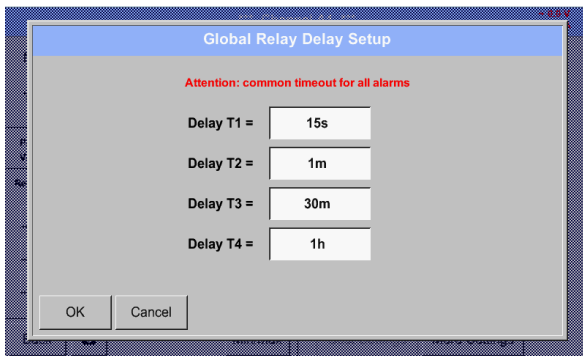

The delays (T1 to T4) are free definable but are common valid for all relays.

Main menu → Settings → Sensor settings → A1 → Alarm-Button → description field Delay T1

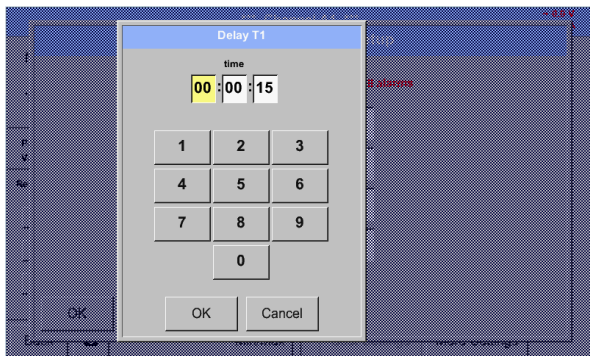

By changing the text field values the new delay time could be defined. Here for *Delay T1*.

Delay T0 is preset and can't be changed and it is an immediate alarm.

Confirmation by pressing the *OK* button.

Same procedure for the remaining delay times T2-T4 is to apply.

Main menu → Settings → Sensor settings → A1

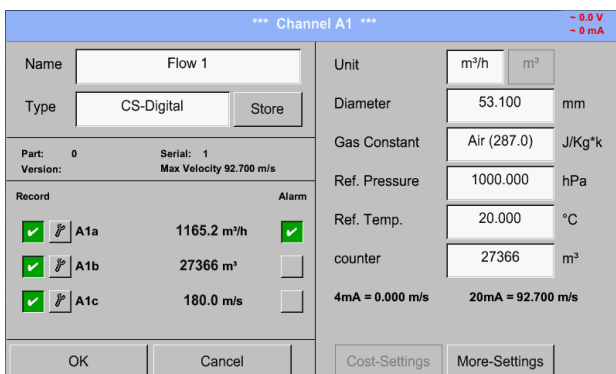

After the alarm activation at channel A1.

The settings finished by pushing the *OK* button!

9.3.3 Dew point sensor with type CS-Digital

First step: choose an unused sensor channel

Main menu → Settings → Sensor settings → A1

Second step: choose type CS-Digital

Main menu → Settings → Sensor settings → A1 → Type description field → CS-Digital

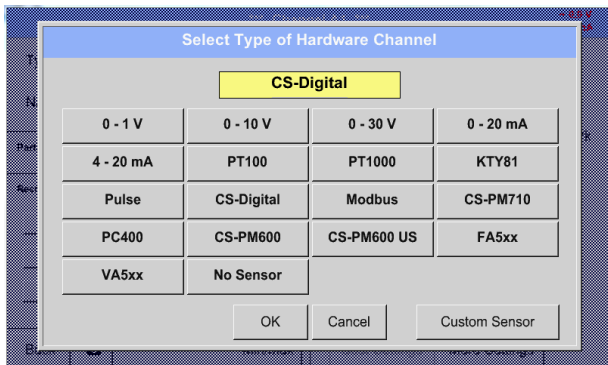

Now the **Type CS-Digital** is selected for the VA/FA 400 series and confirmed by pressing the **OK** button.

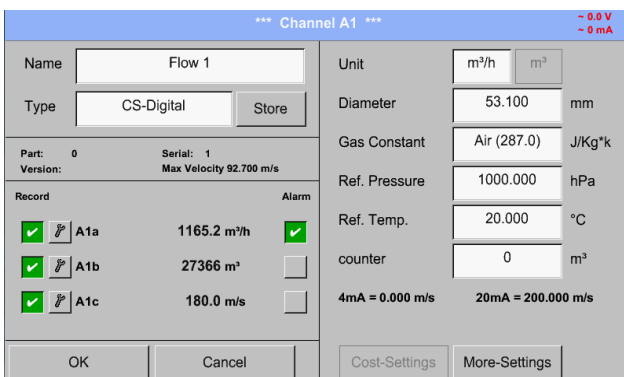

The DS 500 detects, if the connected sensor is a flow or dew point sensor of **CS Instruments** and set the **CS-Digital** subtype automatically correct.

Now, a **Name** (See chapter 9.3.2.2 Label and setting the description fields), the **alarm settings** (See chapter 9.3.2.5 Alarm settings) and **recording settings** (See chapter 9.3.2.4 Recording measurement data), and the **Resolution of the decimal places** (See chapter 9.3.2.3 Name measurement data and define the decimal places) can be determined.

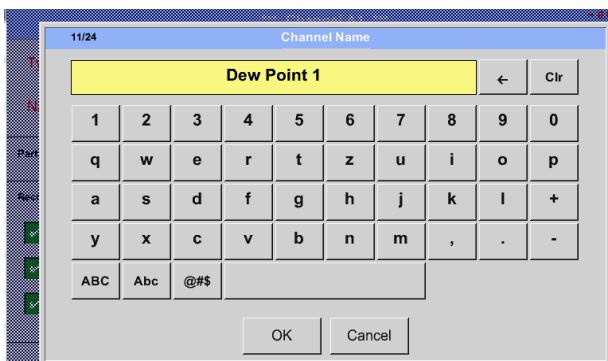

It is possible to enter a name with 24 characters.

Third step: confirm with **OK** two times

9.3.4 Flow sensor VA 400 / VA 420 of type CS-Digital (SDI Bus)

First step: choose an unused sensor channel
 Main menu → Settings → Sensor settings → A1

Second step: choose type CS-Digital
 Main menu → Settings → Sensor settings → A1 → Type description field → CS-Digital

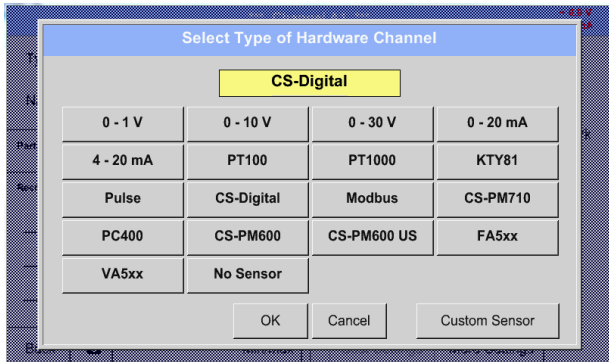

Now the *Type CS-Digital* is selected for the VA/FA 400 series and confirmed by pressing the **OK** button.

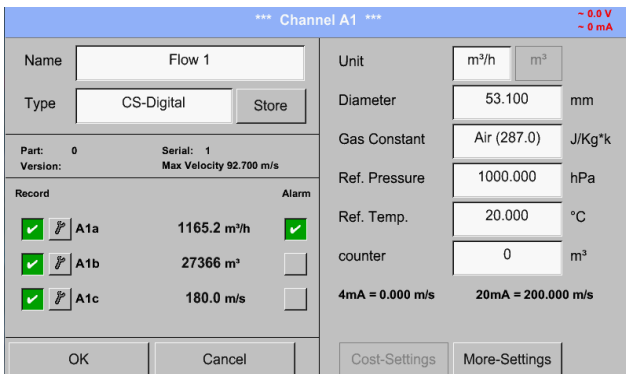

The DS 500 detects, if the connected sensor is a flow or dew point sensor of **CS Instruments** and set the **CS-Digital** subtype automatically correct.

Now, a **Name** (See chapter 19.3.2.2 Label and setting the description fields), the **alarm settings** (See chapter 9.3.2.5 Alarm settings) and **recording settings** (See chapter 9.3.2.4 Recording measurement data), and the **Resolution** of the decimal places (See chapter 9.3.2.3 Name measurement data and define the decimal places) can be determined.

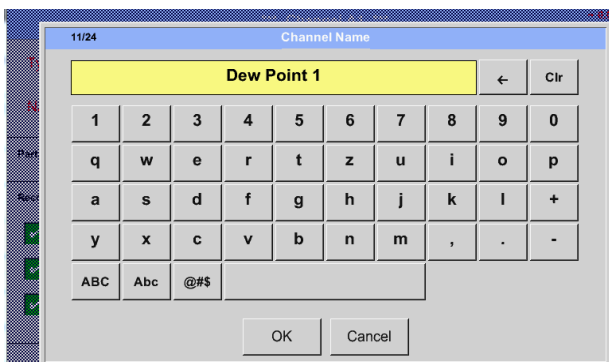

It is possible to enter a name with 24 characters.

Third step: confirm with **OK** two times

Main menu → Settings → Sensor settings → A1

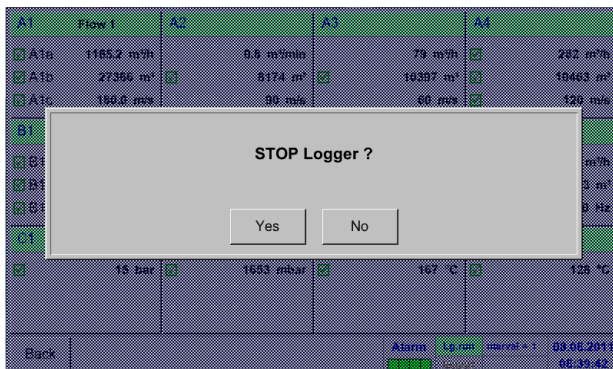

If the data logger is activated, the following window will appear and via pushing **Yes** it can be disabled.

(Only activated, if already settings and recordings are made)

Remark:

If sensor settings are defined or changed, the data logger must be stopped.

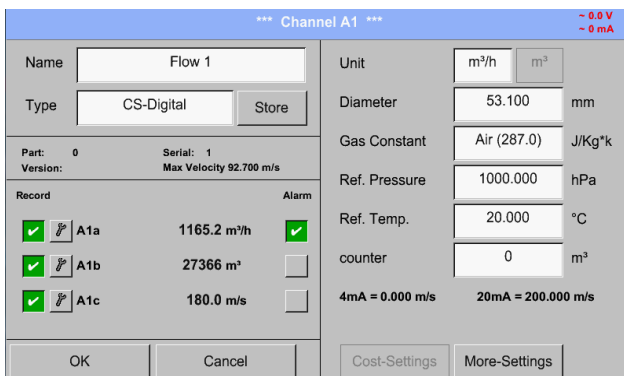

Changes or entries can be made by pressing the highlighted white fields.

Main menu → Settings → Sensor settings → A1 → description field of numerical value

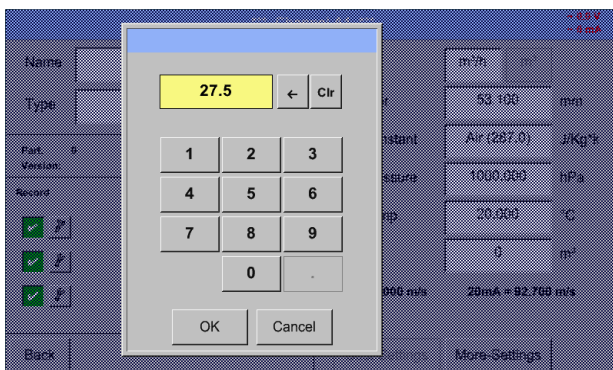

Important:

The **inner diameter** of flow tube can be entered here, if this was not automatically correctly set.

Inner diameter is entered here for example 27.5 mm.

Important:

The **inner diameter** should be entered as precisely as possible, because otherwise the measurement results are not correct!

There is no uniform standard for the tube **inner diameter**!
(Please, inquire at the manufacturer or measure by your own!)

Main menu → Settings → Sensor settings → A1 → Gas Constant description field

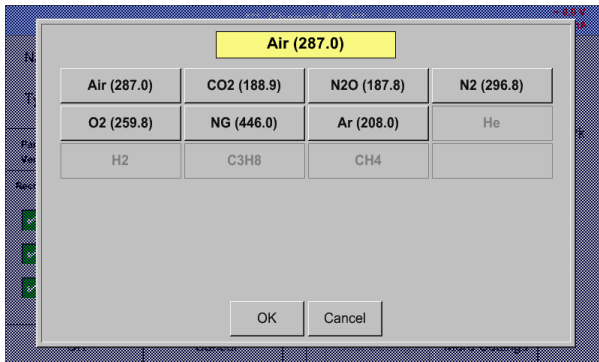

A preset selection of suitable *Gas Constants*.

In the same way as here in chapter 9.3.2.2 Label and set the description fields described, the remaining description fields can be labelled.

Main menu → Settings → Sensor settings → A1

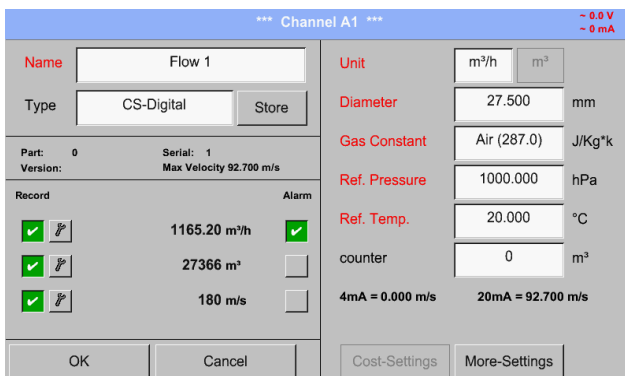

The red labeled description fields indicates that different values, such as the *Diameter* and the *Name*, have been changed or added.

The three parameters of flow, consumption and velocity will be recorded (green hook) after the data logger has been activated.

See also chapter 9.3.2.1 Choice of the sensor types (For example type CS-Digital sensor)

Remark:

After confirming with **OK**, the font is black again and the values and settings are accepted.

Attention:

Reference temperature and reference pressure (factory setting 20 °C, 1000 hPa):
 All volume flow values (m³/h) and consumption values indicated in the display are related to 20 °C, 1000 hPa (according to ISO 1217 intake condition)
 0 °C and 1013 hPa (= standard cubic meter) can also be entered as a reference.
 Do not enter the operation pressure or the operation temperature under reference conditions!

9.3.4.1 More-Settings (scale analogue output)

Main menu → Settings → Sensor settings → A1 → More-Settings

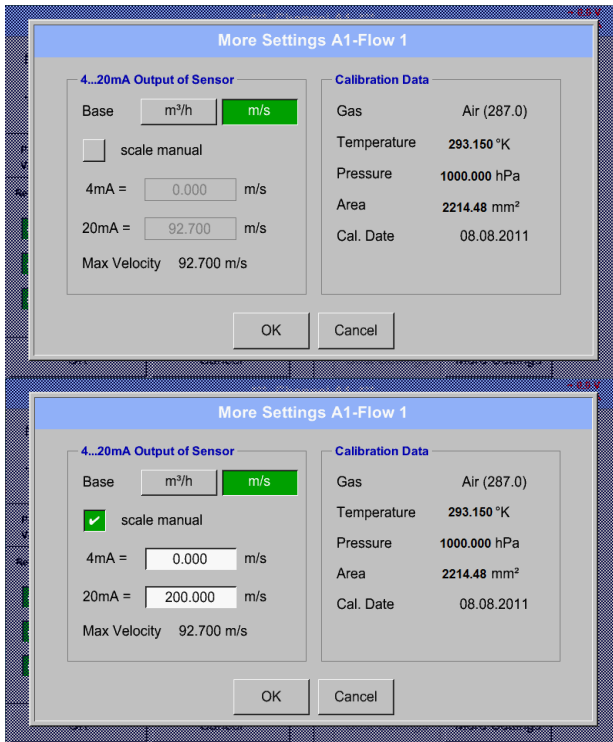

In *More-Settings*, you can define whether the 4 - 20 mA analogue output of the sensor based on the flow rate or velocity.

The green highlighted description field is selected!

In addition, you can push the *scale manual* button and set the measuring range.

After confirming with *OK*, the settings are assumed.

Remark:
More-Settings only for type **CS-Digital** available!

By pressing the **OK** button the settings are ready!

9.3.5 Dew Point Sensor of type FA 5xx (RS 485 Modbus)

First step: choose an unused sensor digital channel

Main menu → Settings → Sensor settings → A1

Second step: choose type FA 5xx (inserted Digitalboard for A1/A2)

Main menu → Settings → Sensor settings → A1 → Type description field → FA 5xx

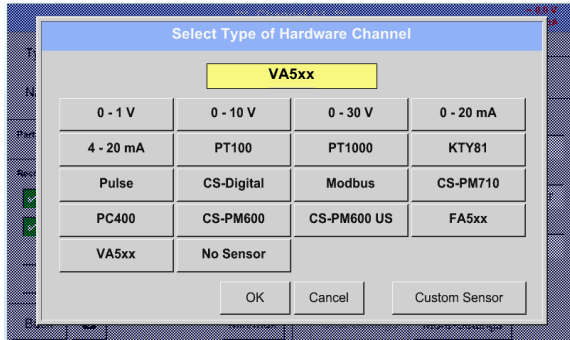

Now the *Type FA 5xx* is selected for the FA 5xx series and confirmed by pressing the **OK** button.

Now, a **Name** (See chapter 9.3.2.3 Label and setting the description fields), the **alarm settings** (See chapter 9.3.2.5 Alarm settings) and **recording settings** (See chapter 9.3.2.4 Recording measurement data), and the **Resolution** of the decimal places (See chapter 9.3.2.3 Name measurement data and define the decimal places) can be determined.

Main menu → Settings → Sensor settings → A1 → Name description field

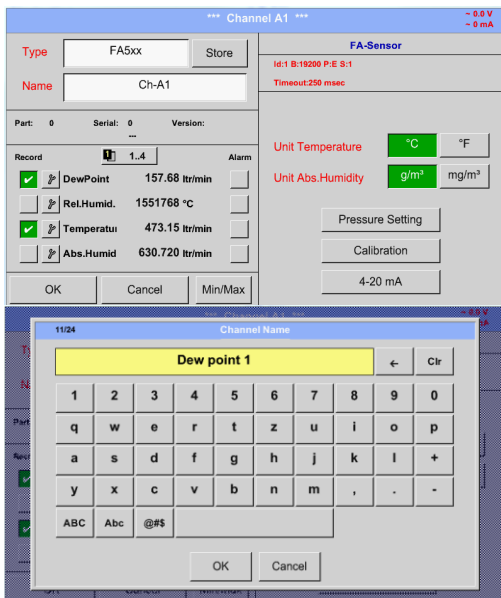

For input of a name, please enter the text field **„Name“**.

It is possible to set a name with max. 24 characters.

Confirmation by pressing the **OK**-button.

9.3.5.1 Setting s Dew point sensor FA 500 / FA 510

9.3.5.1.1 Unit selection for temperature and humidity

Main menu → Settings → Sensor settings → A1

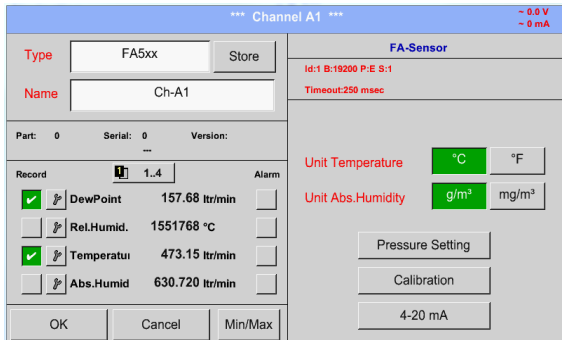

Unit selection for temperature and humidity by pressing the button °C, °F, g/m³ or mg/m³.
Confirm the settings by pressing the OK button.

9.3.5.1.2 Definition of the System pressure (relative pressure value)

Actual there are 2 possibilities to define system pressure (input as relative pressure value)

- System pressure as a fixed value
- System pressure taken over from an external pressure sensor

Main menu → Settings → Sensor settings → A1 → Pressure Setting → Fixed

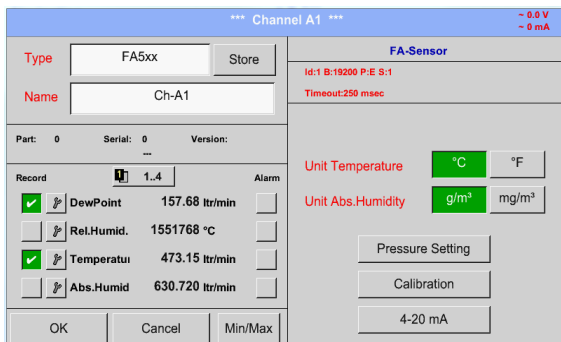

The definition of the fixed value system pressure value is done by activating the button "fixed", but this is only required in case a ext. pressure probe is connected.
The value is entered in the corresponding text field. The unit can be freely selected, selection menu is opened by pressing the corresponding unit-button.
Confirm the settings by pressing the OK button.

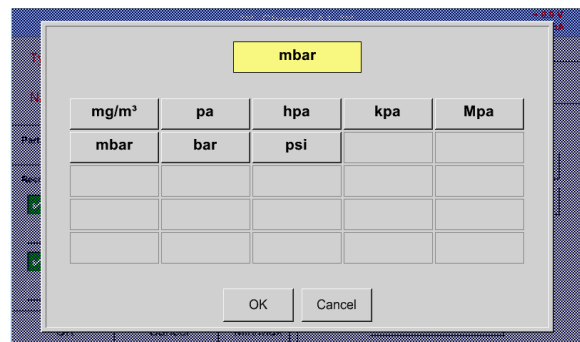
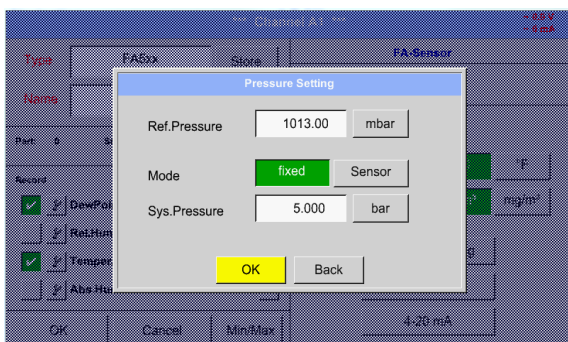

Main menu → Settings → Sensor settings → A1 → Pressure Setting → Sensor

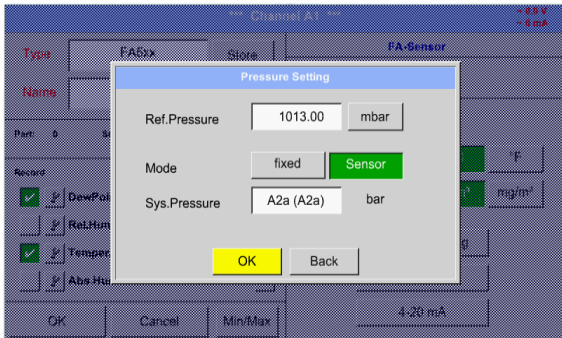

By using an ext. pressure sensor, which is detected automatically e.g. here at input B1, the button **Sensor** has to be activated.

With activation of the text field „Sys Pressure“ the corresponding channel with the required measuring value could be selected

Only values with pressure units can be selected.

Confirm the settings by pressing the **OK** button.

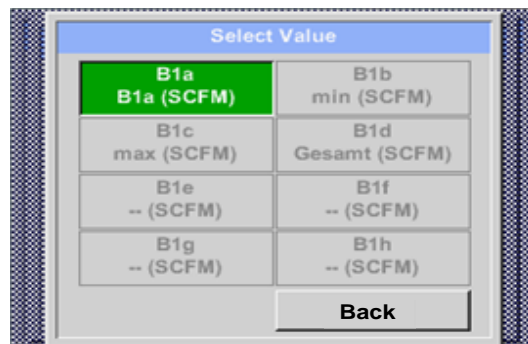
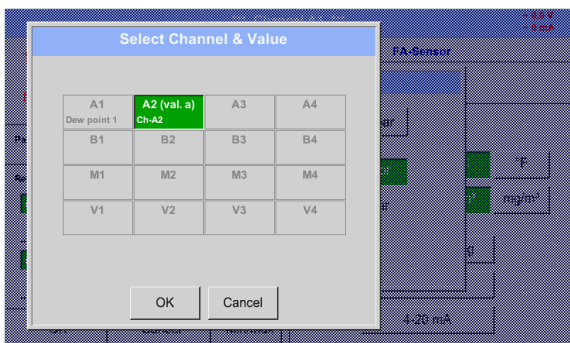

9.3.5.1.3 Definition of Reference pressure (absolute pressure value)

Main menu → Settings → Sensor settings → A1 → arrow right (2.page) → Pressure Setting → Textfield Ref. Pressure

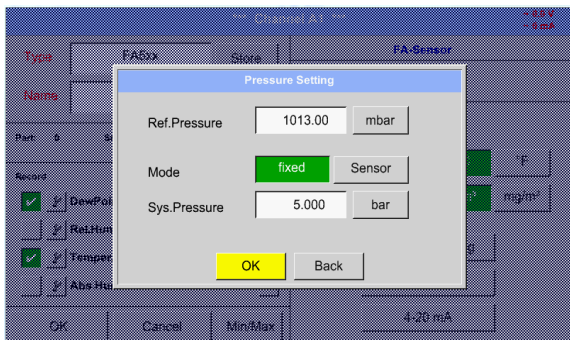

Reference pressure is the pressure for that the dew point in relaxation will be back-calculated.

Default- Value is 1013 mbar (Atm. Pressure).

Confirm the settings by pressing the **OK** button.

9.3.5.1.4 Calibration

Main menu → Settings → Sensor settings → A1 → Calibration

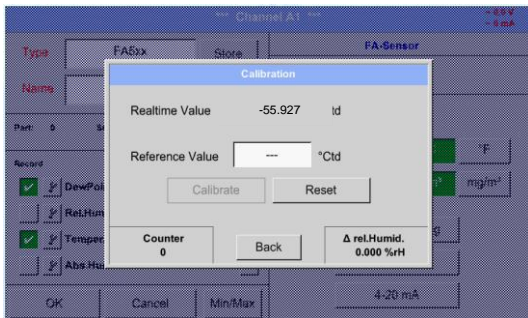

5.6314

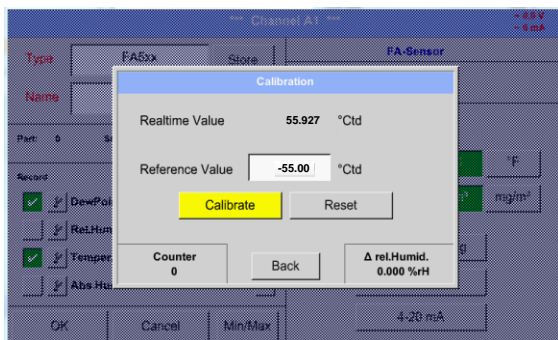

Here, a one-point calibration can be performed.

For that purpose, please enter in the text box "Reference Value" the new correct dew point value.

Then by pressing the "Calibration" button taking over the inserted reference value.

Calibration can be put back to factory setting by pressing „Reset“.

For each performed calibration, the counter is increased by 1.

9.3.5.1.5 More Settings Analogue output 4-20mA

Main menu → Settings → Sensor settings → A1 → More-Settings → 4-20mA

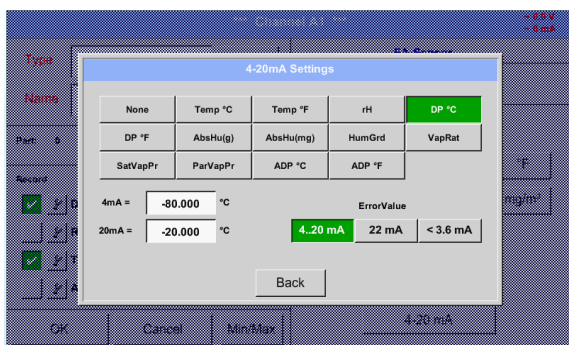

This menu allows the adjustment / assignment of the measurement value and the scaling of the analogue output.

Selection of the measurement value by selecting the appropriate measured value key in this example, "DP ° C" for dew point ° Ctd.

In text fields "4mA" and "20mA" the appropriate scaling values are entered, here from -80 ° Ctd (4mA) to -20 ° Ctd (20mA).

With "Error Val" is determined what is output in case of error at the analog output.

- <3.6 Sensor error / System error
- 22 Sensor error / System error
- 4..20 Output according Namur (3.8mA – 20.5 mA)
- < 4mA to 3.8 mA Measuring range under range
- >20mA to 20.5 mA Measuring range exceeding

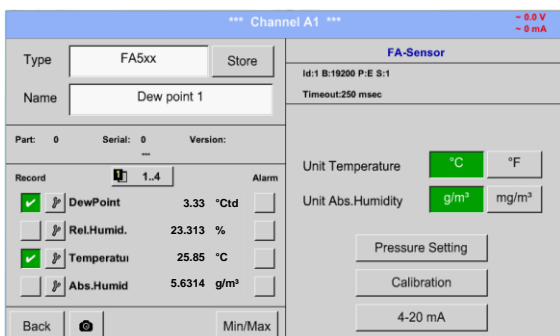

Confirm the settings by pressing the OK button.

9.3.6 Flow sensor of type VA 5xx (RS 485 Modbus)

First step: choose an unused sensor digital channel

Main menu → Settings → Sensor settings → A1

Second step: choose type VA 5xx

Main menu → Settings → Sensor settings → A1 → Type description field → VA 5xx

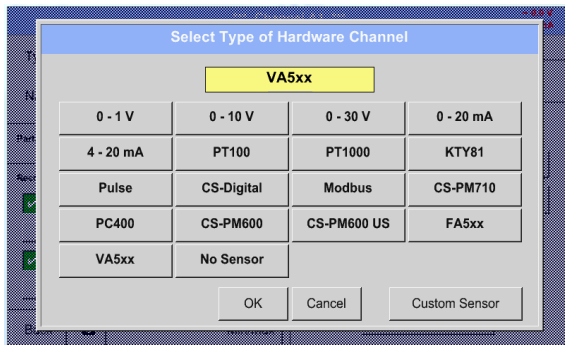

Now the *Type VA 5xx* is selected for the VA 5xx series and confirmed by pressing the **OK** button.

Now, a **Name** (See chapter 9.3.2.3 Label and setting the description fields), the **alarm settings** (See chapter 9.3.2.5 Alarm settings) and **recording settings** (See chapter 9.3.2.4 Recording measurement data), and the **Resolution** of the decimal places (See chapter 9.3.2.3 Name measurement data and define the decimal places) can be determined.

Main menu → Settings → Sensor settings → A1 → Name description field

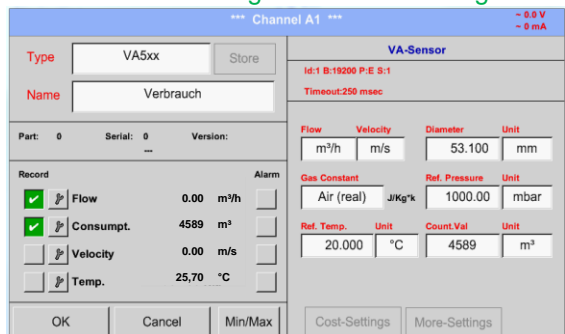

Input of a name, please enter the text field **„Name“**.

It is possible to enter a name with max. 24 characters.

Confirmation by pressing the **OK**-button.

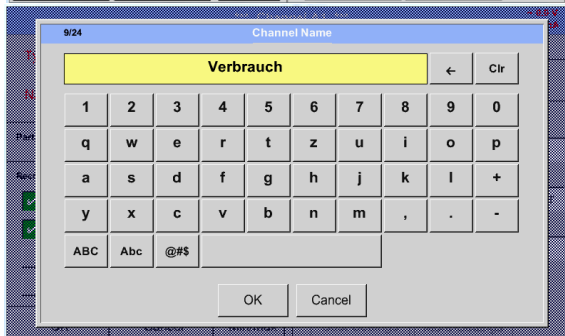

9.3.6.1 Settings for Flow sensor VA 5xx

Main menu → Settings → Sensor settings → A1

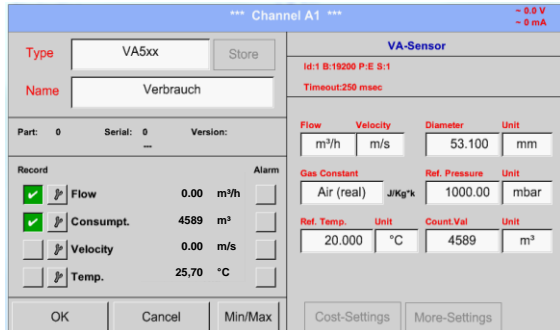

For each text field could be the either a value or a unit be set.

Settings by entering the text field and then input a value or select the unit for the appropriate field.

In case of VA 520 and VA 570 with integrated measuring section the diameter and diameter unit field are not access able.

Please confirm all changes /inputs by pressing the **OK** button

9.3.6.1.1 Diameter settings

Main menu → Settings → Sensor settings → A1 → diameter description field

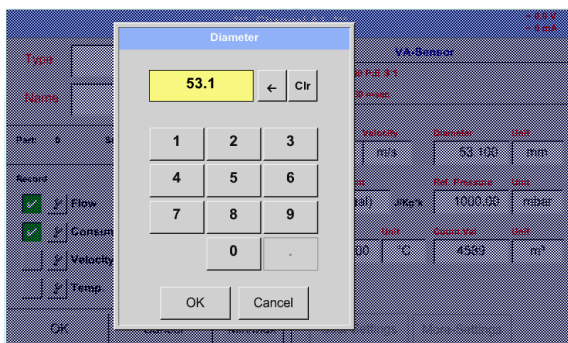

Important:

The **inner diameter** of flow tube can be entered here, if this was not automatically correctly set.

In

Please confirm by pressing the **OK** button.

Important:

The **inner diameter** should be entered as precisely as possible, because otherwise the measurement results are not correct!

There is no uniform standard for the tube **inner diameter**!
(Please, inquire at the manufacturer or measure by your own !)

Main menu → Settings → Sensor settings → A1 → diameter unit description field

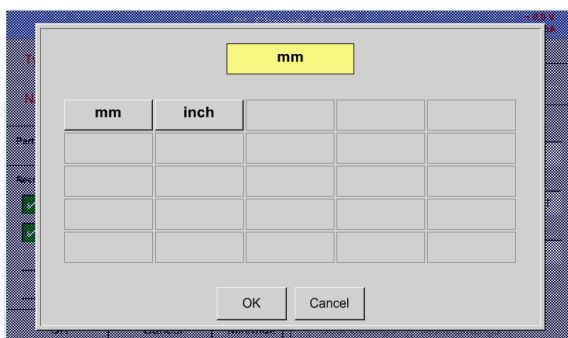

9.3.6.1.2 Gas Constant settings

Main menu → Settings → Sensor settings → A1 → Gas Constant description field

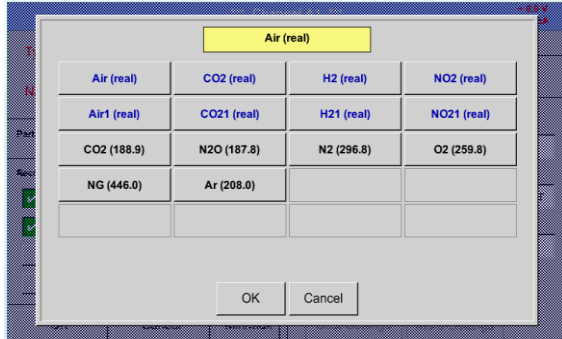

All gases marked in blue and with (real) have been a real gas calibration curve stored in the sensor.

Select the gas you require and confirm selection by pressing **OK** button.

Attention:

Reference temperature and reference pressure (factory setting 20 °C, 1000 hPa):
All volume flow values (m³/h) and consumption values indicated in the display are related to 20 °C, 1000 hPa (according to ISO 1217 intake condition)
 0 °C and 1013 hPa (= standard cubic meter) can also be entered as a reference.
Do not enter the operation pressure or the operation temperature under reference conditions!

9.3.6.1.3 Definition of the reference conditions

Here, the desired measured media reference conditions for pressure and temperature can be defined

Main menu → Settings → Sensor settings → A1 → Ref. Pressure description field

Main menu → Settings → Sensor settings → A1 → Ref. Pressure Unit description field



Main menu → Settings → Sensor settings → A1 → Ref. Temp. description Field

Main menu → Settings → Sensor settings → A1 → Ref. Temp. Unit description Field

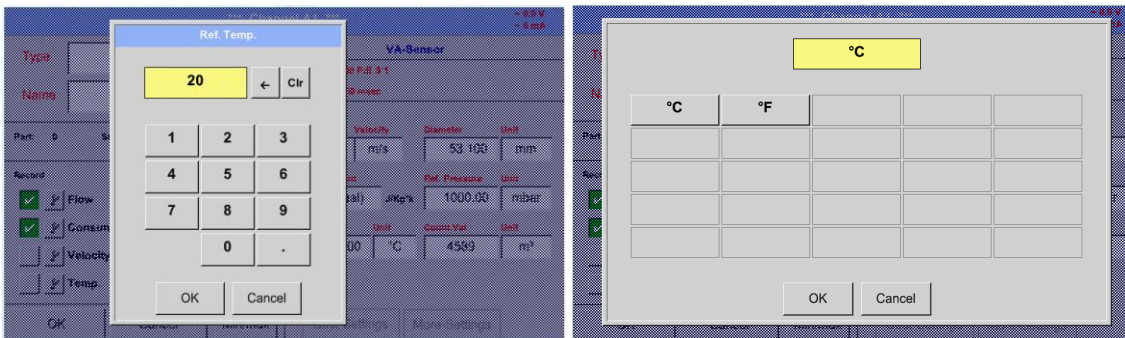

9.3.6.1.4 Definition Unit of flow and velocity

Main menu → Settings → Sensor settings → A1 → Flow description Field

Main menu → Settings → Sensor settings → A1 → Velocity description Field

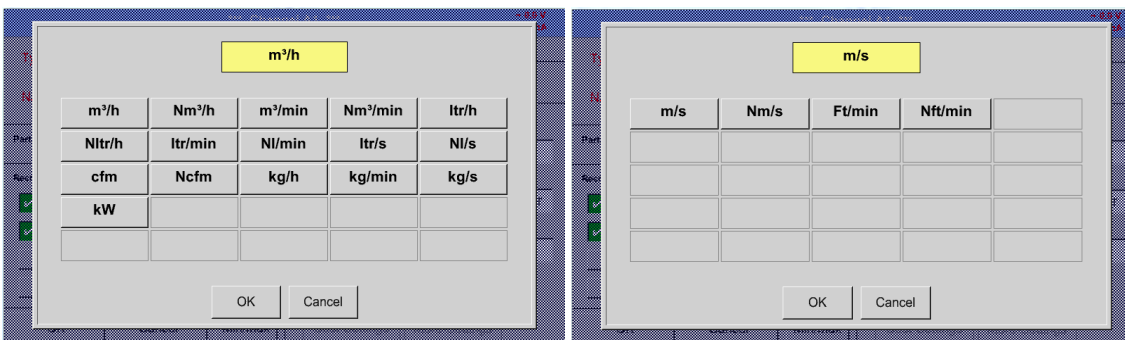

9.3.6.1.5 Definition consumption counter value and consumption unit

Main menu → Settings → Sensor settings → A1 → Count Val. description Field

Main menu → Settings → Sensor settings → A1 → Count Val. Unit description Field

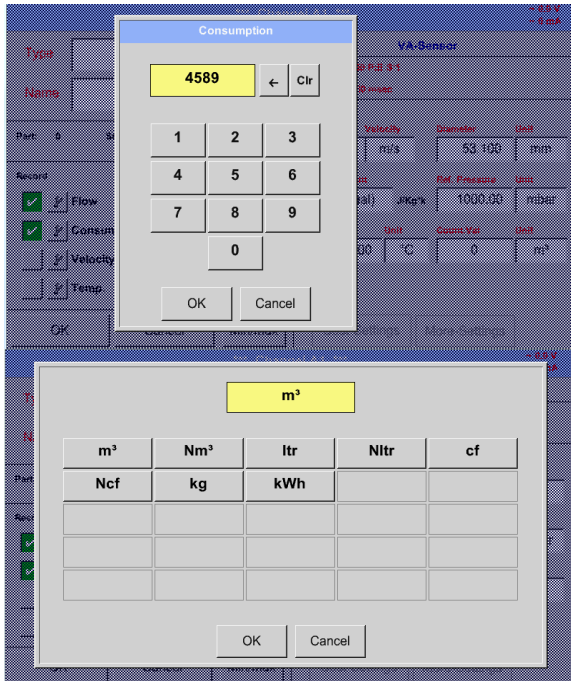

The sensor allows taking over a starting counter value. Inserting the value by entering the "Count. Val." text field.

In the Count. Val. Unit field different units could be used. Selection by activation of the "Count. Val. Unit" text field

In case the counter value unit will be changed only the consumption counter value will be recalculated to the appropriate unit.

Selection to confirm selection by pressing **OK** button.

Important!
When the counter reach 10000000 m³ the counter will be reset to zero.

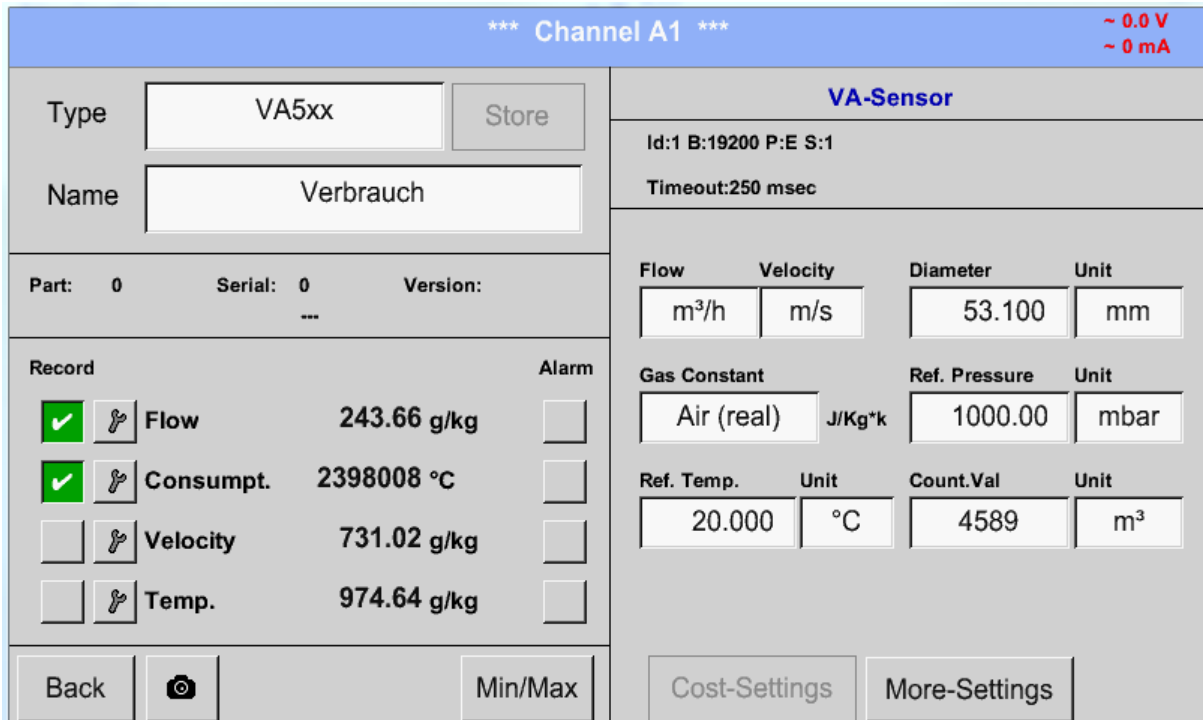
Remark:

 After confirmation with **OK**, the font is black again and the values and settings are accepted

9.3.6.2 Settings analogue output 4-20mA of VA 5xx

Main menu → Settings → Sensor settings → arrow right (2nd page) → More-Settings → 4-20mA Ch1

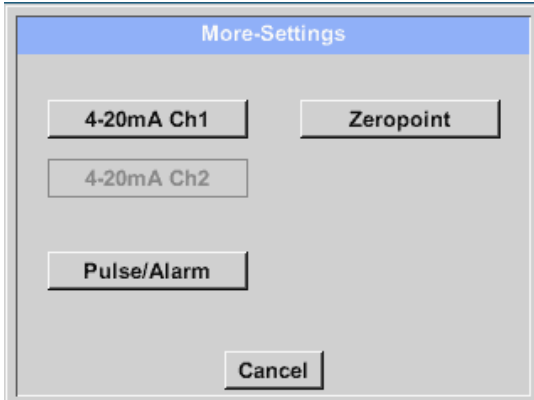

This menu allows the adjustment / assignment of the measurement value and the scaling of the analogue output by pressing the "4-20mA Ch1" button.

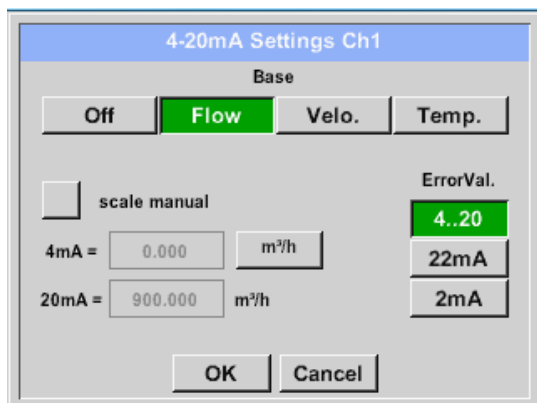

Selection of the analogue output measurement value by activating the appropriate measured value key in this example, "Flow".

Possible outputs are flow, velocity and temperature. In case of no use, please select "Off".

The analogue output scaling have to possibilities, automatic scaling (default) and a manual scaling by the user. Auto scaling is based on the calibration settings, means 4mA is set to zero and the 20mA value is based on the max. settings here 900m³/h

A "manual scaling" needs an activation of the "scale manual" button.

In text fields "4mA" and "20mA" the appropriate scaling values are entered, here from zero m³/h (4mA) to 300 m³/h (20mA).

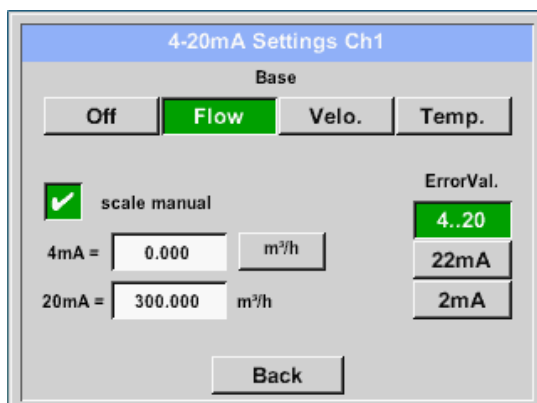

With "Error Val" it is determined what is the output in case of an error at the analogue output.

- 2 mA Sensor error / System error
- 22 mA Sensor error / System error
- 4..20 Output according Namur (3.8mA – 20.5 mA)
< 4mA to 3.8 mA Measuring range under range
>20mA to 20.5 mA Measuring range exceeding

Inputs / changes to be confirmed with "OK" button. Return to main menu with "Back".

9.3.6.3 Settings Pulse / Alarm output of VA 5xx

Main menu → Settings → Sensor settings → → More-Settings → Pulse / Alarm

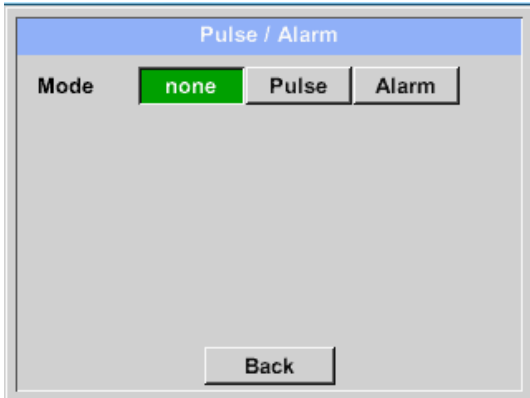

The pulse output of the VA 5xx could be set functionally as pulse output or alarm output.

Function to activate by pressing either the "Pulse" or "Alarm" button.

In case of no use, please select "none".

Inputs / changes to be confirmed with "OK" button. Return to main menu with "Back".

Main menu → Settings → Sensor settings → → More-Settings → Pulse

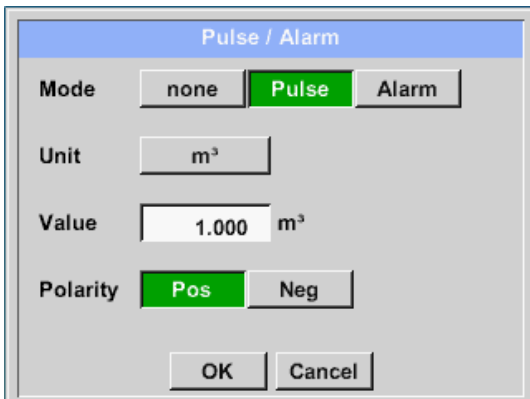

To set up the pulse first the unit and the measurement value have to be defined. Unit selection by pressing "unit" button and choice one of the possible units "kg", "cf", "ltr" or "m³".

Pulse weight setting by entering the text field "Value".

Here with defined 1 pulse per m³ and with positive polarity.

With „Polarity“ the switching state could be defined.

Pos. = 0 → 1 neg. 1 → 0

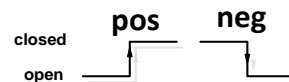

Inputs / changes to be confirmed with "OK" button. Return to main menu with "Back".

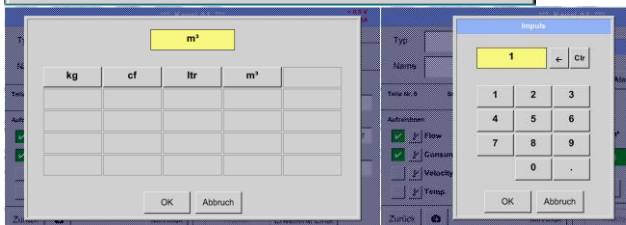

Main menu → Settings → Sensor settings → → More-Settings → Alarm

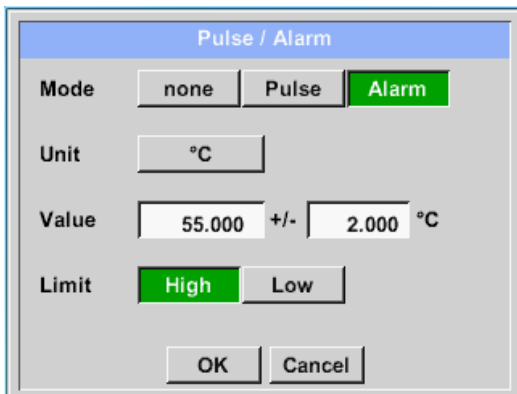

In case of use the pulse output as alarm following definitions needs to be set:

Unit selection by pressing "unit" button and choice one of the possible units "cfm", "ltr/s", "m³/h", "m/s", "°F", "°C", "kg/s" or "kg/min".

Alarm value setting by entering the text fields "Value".

The limits „High“ or „Low“ defines when the alarm is activated, selecting by pressing the appropriate button

High: Value over limit

Low: Value under limit

Inputs / changes to be confirmed with "OK" button. Return to main menu with "Back".

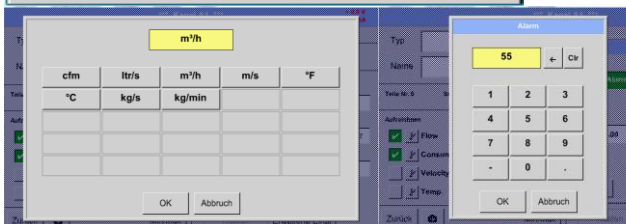

9.3.6.4 Settings ZeroPoint or Low Flow Cut off for VA 5xx

Main menu → Settings → Sensor settings → → More-Settings → Zeropoint

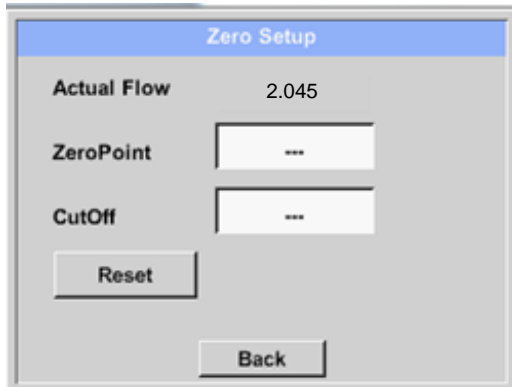

Zero Setup

Actual Flow 2.045

ZeroPoint

CutOff

Reset

Back

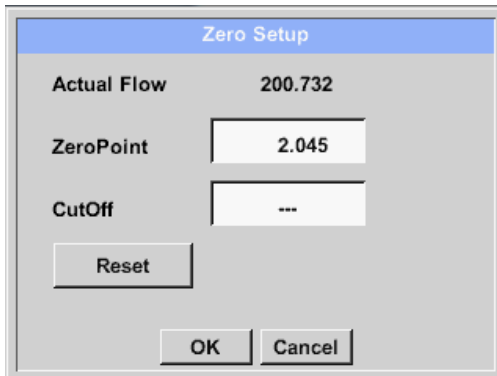

Zero Setup

Actual Flow 200.732

ZeroPoint

CutOff

Reset

OK Cancel

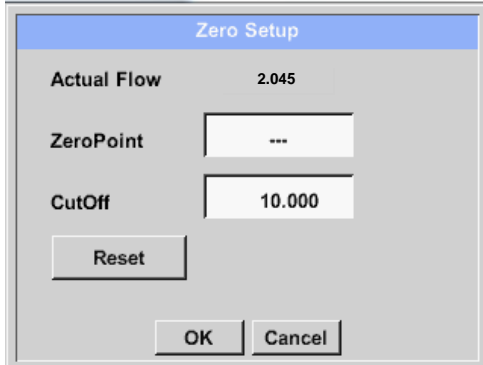

Zero Setup

Actual Flow 2.045

ZeroPoint

CutOff

Reset

OK Cancel

With these function following adjustments for the sensor VA 5xx could be done:

Zeropoint:

When, without flow, the installed sensor shows already a flow value of $> 0 \text{ m}^3/\text{h}$ herewith the zero point of the characteristic could be reset

Cutoff:

With the low-flow cut off activated, the flow below the defined "LowFlow Cut off" value will be displayed as $0 \text{ m}^3/\text{h}$ and not added to the consumption counter.

For Zero Point the text field "ZeroPoint" to enter and insert the displayed actual flow, here 2.045

For inserting low flow cutoff value activate the text field "CutOff" and insert the required value, here 10.

With the "Reset" button all entries could be set back to zero.

Inputs / changes to be confirmed with "OK" button. Return to main menu with "Back".

9.3.7 Configuration of analogue sensors

A brief overview of the possible *Type* of settings with examples.

Except *CS-Digital*, see chapter 9.3.2.1 Choice of the sensor types (For example type CS-Digital sensor) and 9.3.3 Dewpoint sensor with type CS-Digital.

The **Alarm** (See chapter 9.3.2.5 Alarm settings) and **Record** buttons (See chapter 9.3.2.4 Recording measurement data), the **Resolution of the decimal places** and **Short Name or Value Name** (See chapter 9.3.2.3 Name measurement data and define the decimal places) are all described in chapter 9.3.2 Sensor settings.

The caption of description fields, see chapter 9.3.2.2 Label and setting the description fields.

9.3.7.1 Type 0 - 1/10/30 Volt and 0/4 - 20 mA

Main menu → Settings → Sensor settings → A1 → Type description field → 0 - 1/10/30 V

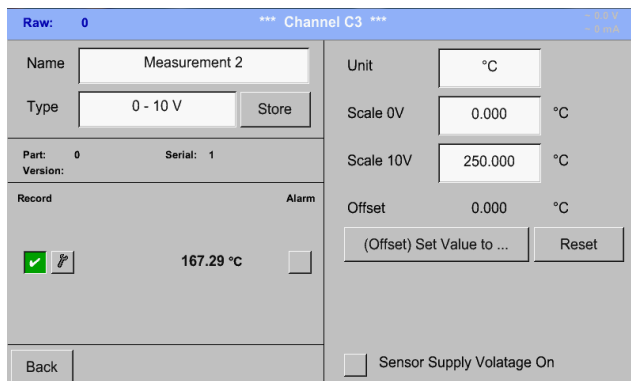

Please see the scale of the sensor (here for example **Type 0 - 10V** corresponds to 0 - 250 ° C) from the data sheet of the connected sensor.

By **Scale 0V** enter the lower and by **Scale10V** the upper scale value.

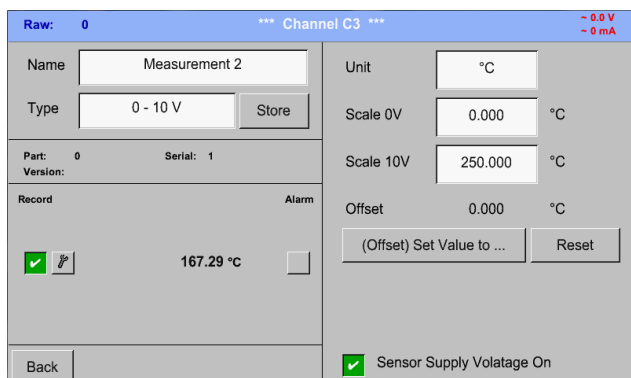

The **Sensor Supply Voltage** is switched **On**, if it's required by the sensor type, otherwise off (no green hook).

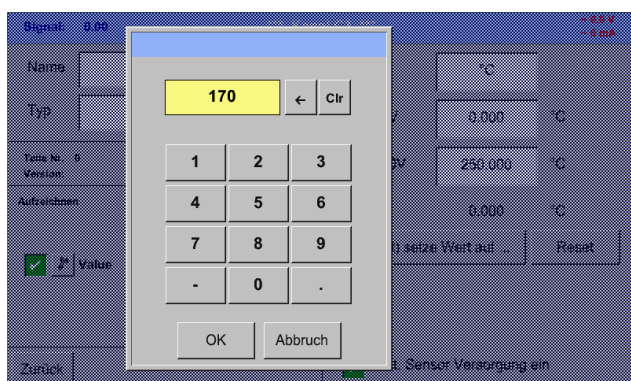

With **Set-Value to-(Offset)** it is possible to set the measurement data to specific value.

the positive or negative difference of the **Offset** is displayed

With the **Reset**-button the **Offset** could be set back to zero.

Main menu → Settings → Sensor settings → A1 → Type description field → 0/4 - 20 mA

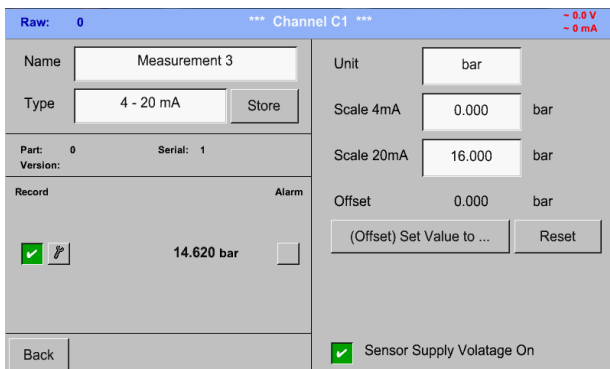

Here for example *Type 4 - 20 mA*.

Main menu → Settings → Sensor settings → A1 → Unit description field

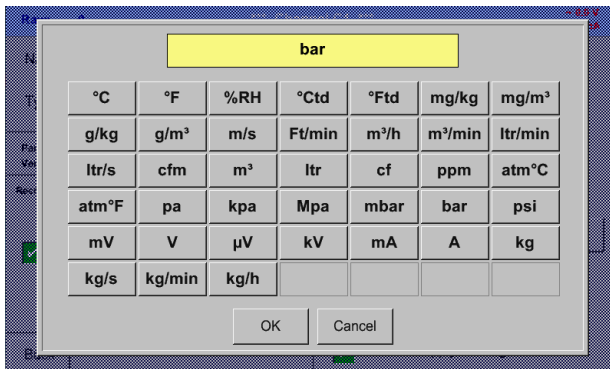

A preset selection of suitable units by *Type 0 - 1/10/30 V* and *0/4...20 mA*.

9.3.7.2 Type PT100x and KTY81

Main menu → Settings → Sensor settings → A1 → Type description field → PT 100x

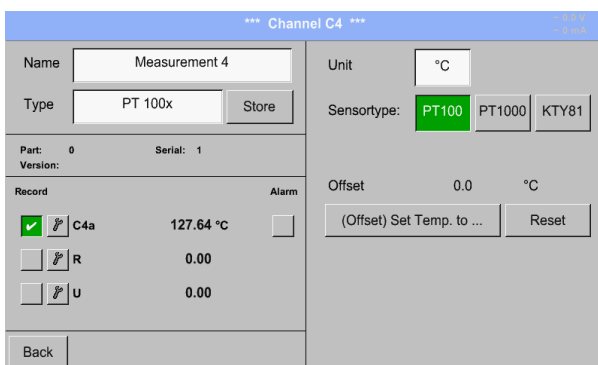

Here the sensor type *PT100* and the *Unit* in °C are chosen, alternatively the sensor types *PT1000* and *KTY81*, as well as the *Unit* °F can be selected.

More setting options, see chapter 9.3.7.1 *Type 0 - 1/10/30 Volt* and *0/4 - 20 mA!*

9.3.7.3 Type Pulse (Pulse ration)

Main menu → Settings → Sensor settings → B3 → Type description field → Pulse

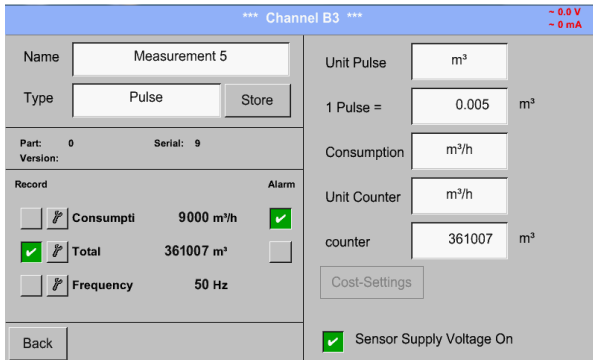

Typically the value with unit of **1 Pulse** is standing on the sensor and can directly entered to the **1 Pulse =** description field.

Remark:
Here, all description fields are already labeled or occupied.

Main menu → Settings → Sensor settings → B3 → Unit Pulse

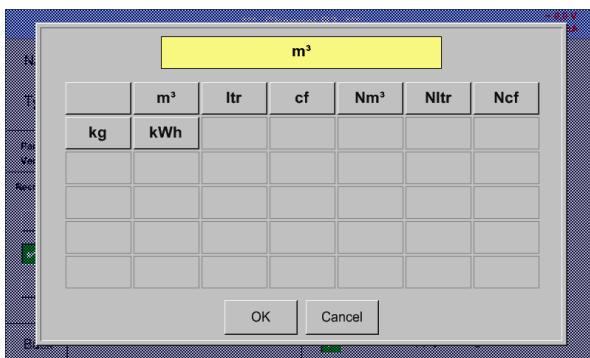

By *Unit Pulse* you can choose between a flow volume or a power consumption unit.

Main menu → Settings → Sensor settings → B3 → Consumption

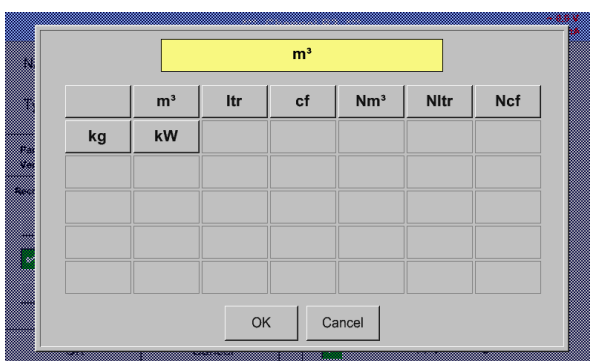

Unit of current *Consumption* by *Type Pulse*

Remark:
Example with the unit cubic meters.

Main menu → Settings → Sensor settings → B3 → Consumption

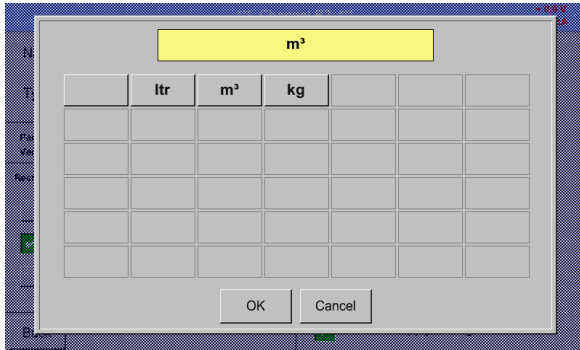

The available Units for the **Unit of Counter** by **Type Pulse**

The **counter** can be set any time to any value you need.

More setting options, see chapter [9.3.7.1 Type 0 - 1/10/30 Volt and 0/4 - 20 mA!](#)

9.3.7.4 Type No Sensor

Main menu → Settings → Sensor settings → A1-C4 → Type description field → No Sensor

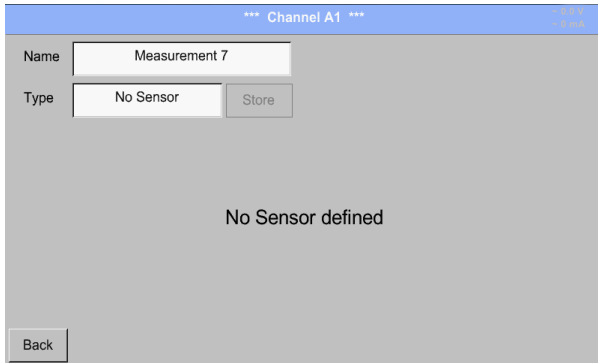

Is used to declare a not currently needed channel as *No Sensor defined*.

A1	Measurement 7	A2	Hall 1.2 comp. air	A3	Hall 1.3 comp. air	A4	Hall 1.4 comp. air
	<i>unused</i>	<input checked="" type="checkbox"/> A2a	0.8 m ³ /min	<input checked="" type="checkbox"/> A3a	79.1 m ³ /h	A4a	282 m ³ /h
		<input checked="" type="checkbox"/> A2b	8174 m ³	<input checked="" type="checkbox"/> A3b	10397 m ³	<input checked="" type="checkbox"/> A4b	10463 m ³
		<input checked="" type="checkbox"/> A2c	90 m/s	<input checked="" type="checkbox"/> A3c	60 m/s	A4c	120 m/s
B1	Hall 2.1 dewpoint	B2	Hall 2.2 dewpoint	B3	Hall 2.3 consumpt.	B4	Hall 2.4 consumpt.
<input checked="" type="checkbox"/>	B1a -9.2 °Ctd	<input checked="" type="checkbox"/>	B2a -45.7 °Ctd	B3a	93 m ³ /h	B4a	174 m ³ /h
<input checked="" type="checkbox"/>	B1b 9.5 %RH	<input checked="" type="checkbox"/>	B2b 0.25 %RH	<input checked="" type="checkbox"/>	B3b 3617 m ³	<input checked="" type="checkbox"/>	B4b 96483 m ³
	B1c 22 °C	<input checked="" type="checkbox"/>	B2c 22.0 °C	B3c	50 Hz	B4c	100 Hz
C1	Hall 3.1 comp. air	C2	Hall 3.2 comp. air	C3	Hall 3.3 temp.1	C4	Hall 3.4 temp.2
<input checked="" type="checkbox"/>	Val 14.6 bar	<input checked="" type="checkbox"/>	Val 1653 mbar	<input checked="" type="checkbox"/>	Val 167.3 °C	<input checked="" type="checkbox"/>	Val 127.6 °C

Back Alarm Lg.stop pacity = 153 08.08.2011 09:39:59

If you go to *Type No Sensor Back*, channel A1 will appear as *unused*.

9.3.8 Typ Modbus

9.3.8.1 Auswahl und Aktivierung des Senortypes

First step: choose an unused sensor channel

Main menu → Settings → Sensor settings → B3

Second step: choose type Modbus

Main menu → Settings → Sensor settings → B3 → Type description field → Modbus

Third step: confirm with **OK**.

Now, a **Name** (See chapter 9.3.2.2 Label and setting the description fields,) can be determined.

Main menu → Settings → Sensor settings → B3 → Va → use



Via Modbus it is possible to read out up to 8 Register-Values (from Input or Holding Register) of the sensor.

Selection by the Register Tabs *Va – Vh* and activation by pressing of the corresponding *Use* button.

9.3.8.2 Modbus settings

Main menu → Settings → Sensor settings → B3 → Modbus Settings

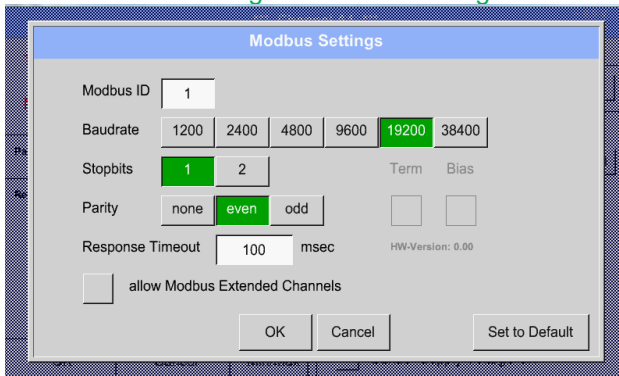

Here are the corresponding values for *Modbus ID*, valid values are 1-247, (e.g. here Modbus ID = 1.), the serial communication settings *baud rate, stop bit, parity and timeout* to define.

Is the DS500 connected at the end of the bus the termination and BIAS to be enable by pressing buttons Term and Bias.

Confirmation with **OK**.

Resetting to basic setting is by pressing button **Set to Default**

With activation of *allow Modbus Extended Channels*, 4 additional channels (M1 –M4) are available and thus 32 sensor values could be queried.

Option is only available with 4 or. 8 channel versions.

Settings see chapter [9.3.9 Option Modbus extended channels](#)

A1	--	A2	--	A3	--	A4	--
	frei		frei		frei		frei
B1	--	B2	--	B3	Ch-B3	B4	--
	frei		frei				frei
M1	--	M2	--	M3	--	M4	--
	frei		frei		frei		frei

Zurück Virtuelle Kanäle Alarm 06.02.2015 08:11:58

Main menu → Settings → Sensor settings → B3 → Modbus ID description field

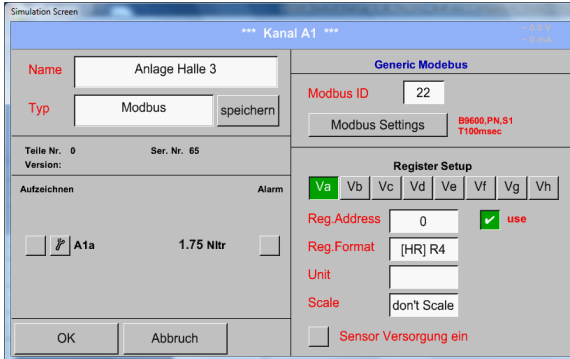

Please insert here the specified *Modbus ID* of the sensor, allowed values are *1 -247*, (e.g.. here *Modbus ID = 22*)

For setting the Modbus ID on the sensor please see sensor-datasheet.

Main menu → Settings → Sensor settings → B3 → Reg. Address description field

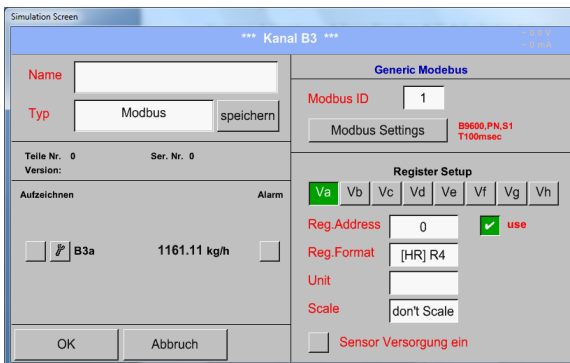

The measurement values are kept in the registers of the sensor and can be addressed via Modbus and read by the DS500.

This requires to set the desired register addresses in the DS500.

Entering the register / data address is here in decimal with 0-65535

Important:

Required is the correct *register-address*.

It should be noted that the register-number could be different to the register-address (Offset). For this please consult the sensor data sheet.

Main menu → Settings → Sensor settings → B3 → Reg. format description field

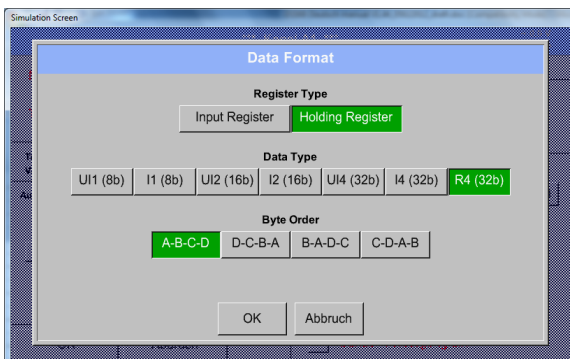

With the buttons *Input Register* and *Holding Register* the corresponding Modbus-register type will be selected.

The number format and transmission order of each value needs to be defined by *Data Type* and *Byte Order*. Both have to be applied in correct combination.

Supported Data types:

Data Type:	UI1 (8b) = unsigned Integer =>	0 - 255
	I1 (8b) = signed integer =>	-128 - 127
	UI2 (16b) = unsigned Integer =>	0 - 65535
	I2 (16b) = signed integer =>	-32768 - 32767
	UI4 (32b) = unsigned Integer =>	0 - 4294967295
	I4 (32b) = signed integer =>	-2147483648 - 2147483647
	R4 (32b) = floating point number	

Byte Order:

The size of each Modbus-register is 2 Byte. For a 32 bit value two Modbusregister will be read out by the DS500. Accordingly for a 16bit Value only one register is read.

In the Modbus Specification the sequence of the transmitted bytes is not defined clearly. To cover all possible cases, the byte sequence in the DS500 is adjustable and must be adapted to the respective sensor. Please consult here for the sensor datasheet.

e.g.: High byte before Low Byte, High Word before Low Word etc

Therefore the settings have to be made in accordance to the sensor data sheet.

Examples :

Holding Register - UI1(8b) - value: 18

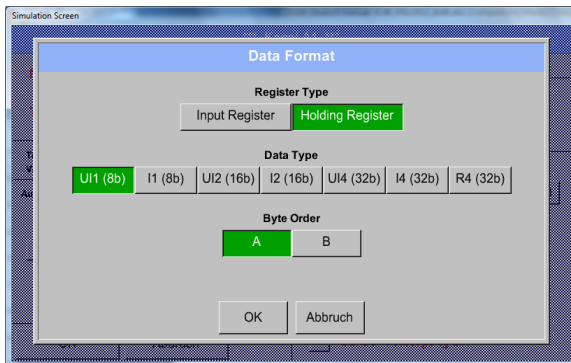

Selection Register Type *Holding Register*,
Data Type *UI1(8b)* und Byte Order *A / B*

	HByte	LByte
18 =>	00	12
Data Order	1. Byte	2. Byte
A	00	12
B	12	00

Holding Register – UI4(32) - Value: 29235175522 → AE41 5652

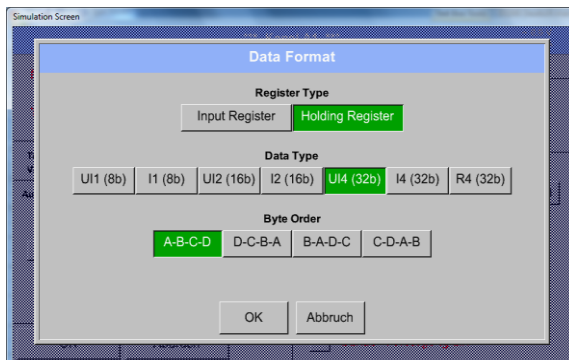

Selection Register Type *Holding Register*,
Data Type *UI1(32b)* und Byte Order *A-B-C-D*

	HWord		LWord	
	HByte	LByte	HByte	LByte
29235175522 =>	AE	41	56	52
Data Order	1.Byte	2.Byte	3.byte	4.Byte
A-B-C-D	AE	41	56	52
D-C-B-A	52	56	41	AE
B-A-D-C	41	AE	52	56
C-D-A-B	56	52	AE	41

Main menu → Settings → Sensor settings → B3 → Unit- description field

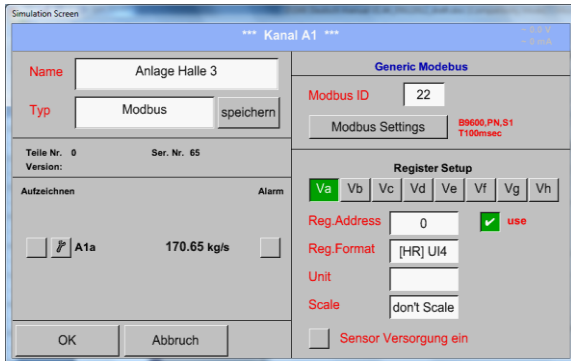

By pressing the description field *Unit* the list with the available units appear

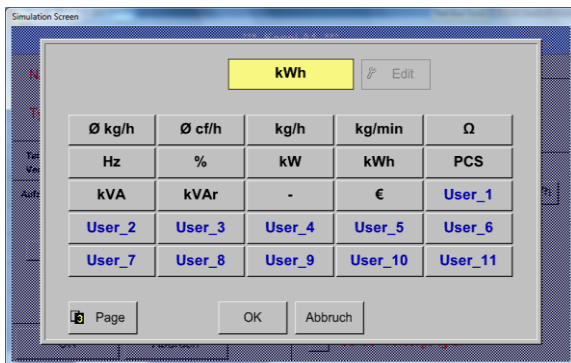

Please select the unit by pressing the respective button e.g. *m³/h*.
For validation of the unit please push the button **OK**
To move through the list please press the button *Page*.
In case the unit is **not** available it is possible to create a user defined unit.
Therefore please select one of the *User_X* buttons..

Main menu → Settings → Sensor settings → B3 → Scale- description field



The use of this factor allows to adapt the output value by the same.

By default or value = 0 no scaling is applied and displayed in the field is *don't scale*

Main menu → Settings → Sensor settings → B3 → OK

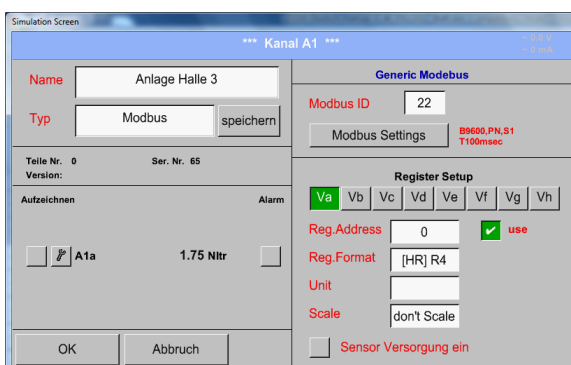

By pressing the **OK** button the inputs are confirmed and stored.

9.3.9 Option Modbus extended channels

This option is only available for DS 500 in Version 4- or 8 channels.

9.3.9.1 Activation of extended Modbus channel

Main menu → Settings → Sensor settings → B3 → Modbus Settings → allow Modbus Extended Channels

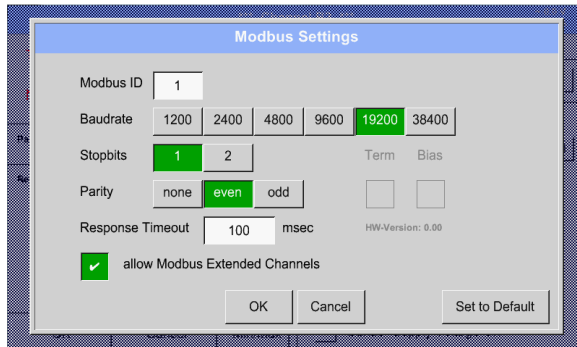

After activation of „*allow Extended Modbus Channels*“ there are 4 additional Modbus channels each with 8 values available.

9.3.9.2 Settings of the extended Modbus channels

1st step: select a free Modbus channel

Main menu → Settings → Sensor settings → M1

2nd step: select type Modbus

Main menu → Settings → Sensor settings → M1 → Typ-Textfield → Modbus

3rd step: confirm it with **OK**

Now a **Name** (see chapter 9.3.2.2 Label and Setting the description field) can be determined.

Main menu → Settings → Sensor settings → M1 → Va → use

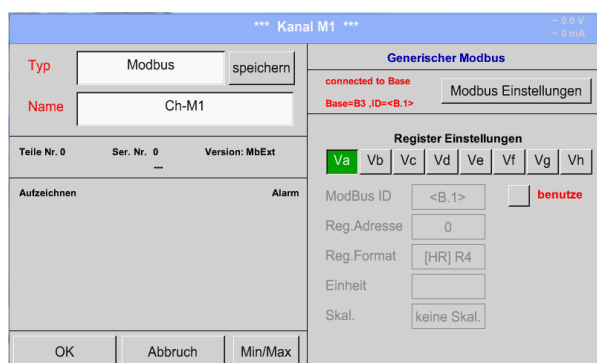

Via Modbus it is possible to read out up to 8 Register-Values (from Input or Holding Register) of the sensor.

Selection by the Register Tabs *Va – Vh* and activation by pressing of the corresponding *Use* button.

9.3.9.3 Modbus Settings

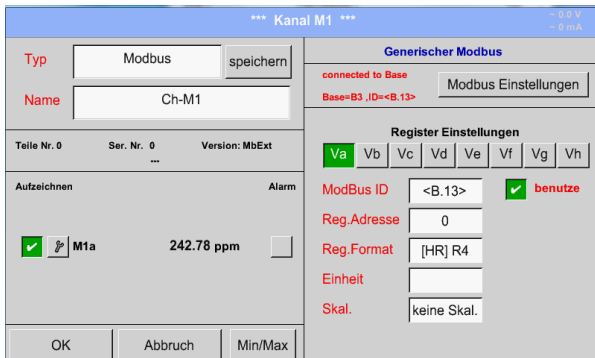

The *Modbus ID* is at initial activation taken over as a copy of the *Modbus settings* of the base channel (marking: value in <>), but it can be overridden.

Main menu → Settings → Sensor settings → M1 → Modbus settings

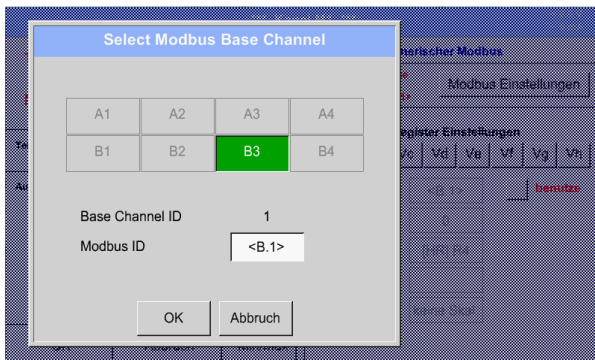

The *Modbus ID* can be taken from a base channel (inherited). This inheritance allows a change in the base channel simultaneous acquisition of change also for the extended channel.

Adoption is not mandatory can be overwritten.

Confirmation by pressing button **OK**.

Main menu → Settings → Sensor settings → M1 → Modbus ID

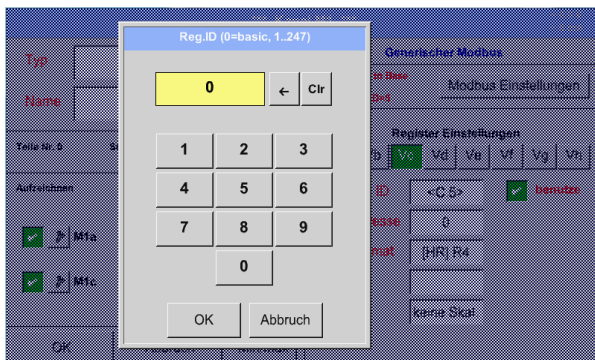

Nevertheless for each register to be read out a individually *Modbus ID* could be defined.

Confirmation by pressing button **OK**.

The other settings are carried out analogously Chapter [9.3.8.2 Modbus Settings](#)

9.3.10 Sensor Settings storing/importing (Custom Sensor)

Once defined sensor settings can be saved for reuse.
Storage of the settings can be made on the internal SD-Cards or an external USB Stick.
This also allows a multiple use on other DS500 devices.

9.3.10.1 Sensor Settings Storing

Main menu → Settings → Sensor settings → B3 → store

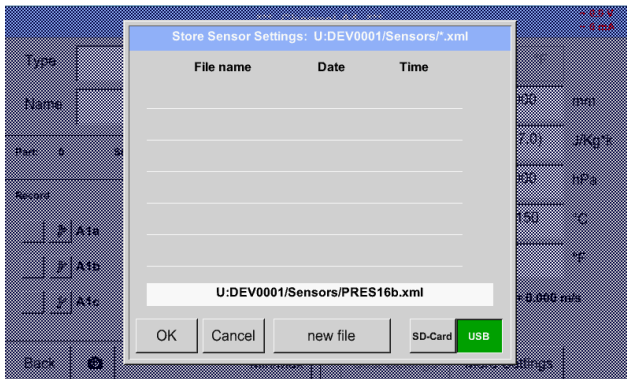

Using the buttons *SD card* or *USB*, the storage location will be determined .

Should the settings be saved in a new file, then press the button *new file*

In case an existing file should be overwritten then selecting the file

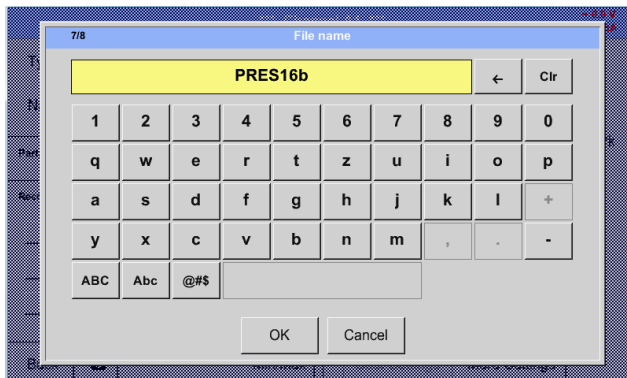

In case of a new file, by pressing the *new file* button, the chosen name must be entered and confirmed with *OK* .

The length of the file name is limited to 8 characters.

The settings are saved as an XML File in the Folder

\\ DEV0001 \ SENSOR \.

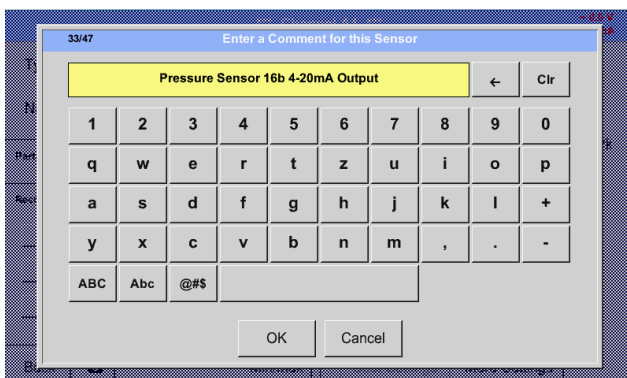

In addition, a comment can be defined which will be displayed in case of a later import.

9.3.10.2 Sensor Settings import

Main menu → Settings → Sensor settings → A1-C4 → Type description field → Custom Sensor

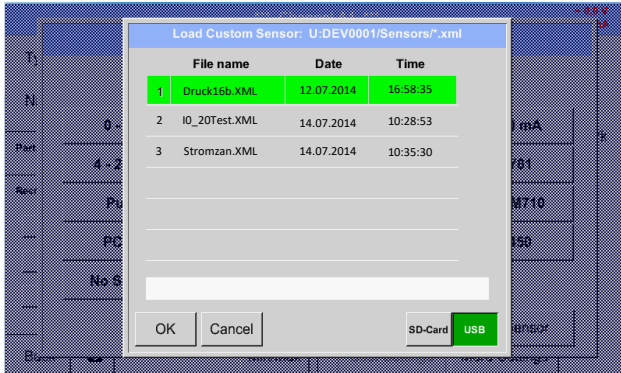

Please select the needed storage location
SD-Card or *USB* stick.

Select the needed file and confirm by pressing
OK.

9.4 Logger settings (data logger)

Main menu → Settings → Logger settings

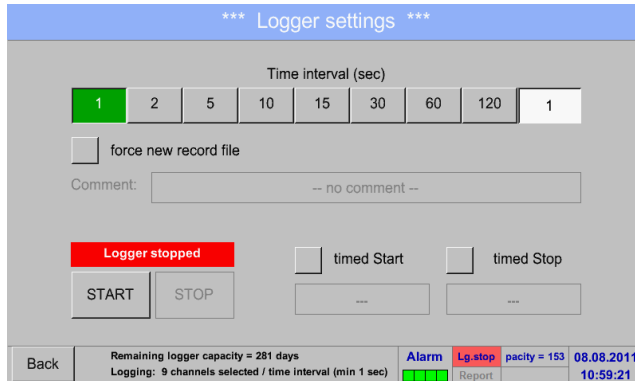

In the top row you can select the predefined *Time intervals* 1, 2, 5, 10, 15, 30, 60 and 120 seconds for recording.

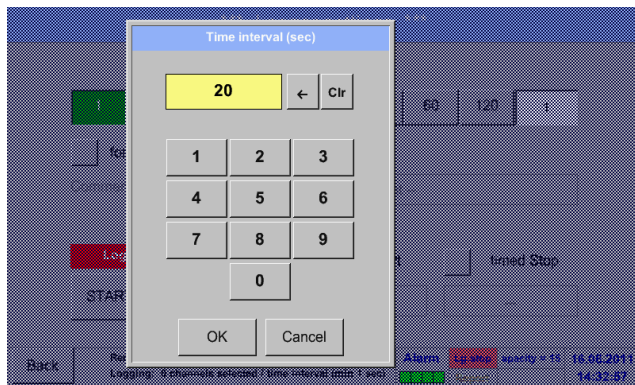

A different, individual *Time interval* can be entered in the highlighted white description field right at the head, where the currently set *Time interval* is always displayed.

Remark:
The largest possible *Time interval* is 300 seconds.

Remark:

If more than 12 measurement data are recorded at the same time, the smallest possible time interval of the data logger is 2 seconds.

And if more than 25 measurement data are recorded at the same time, the smallest possible time interval of the data logger is 5 seconds.

Main menu → Settings → Logger settings → force new Record File button
and

Main menu → Settings → Logger settings → force new Record File button → Comment description field

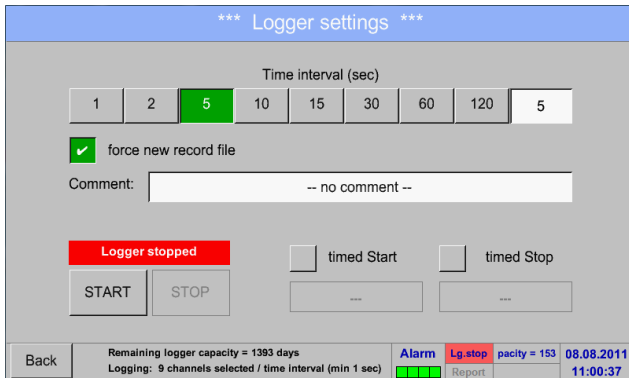

*** Logger settings ***

Time interval (sec)

1 2 5 10 15 30 60 120 5

force new record file

Comment: -- no comment --

Logger stopped

START STOP

timed Start timed Stop

Back Remaining logger capacity = 1393 days Alarm Lg.stop pacity = 153 08.08.2011
Logging: 9 channels selected / time interval (min 1 sec) Report 11:00:37

A new recording file will be created by pushing the *force new record file* button and a name or comment can be entered by the choice of the *Comment* description field.

Important:

If a new recording file should be created, the *force new record file* button must be activated. Otherwise, the last applied recording file is used.

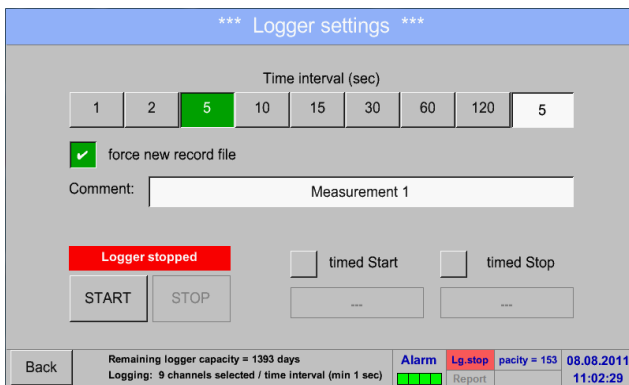

*** Logger settings ***

Time interval (sec)

1 2 5 10 15 30 60 120 5

force new record file

Comment: Measurement 1

Logger stopped

START STOP

timed Start timed Stop

Back Remaining logger capacity = 1393 days Alarm Lg.stop pacity = 153 08.08.2011
Logging: 9 channels selected / time interval (min 1 sec) Report 11:02:29

Main menu → Settings → Logger settings → timed Start button

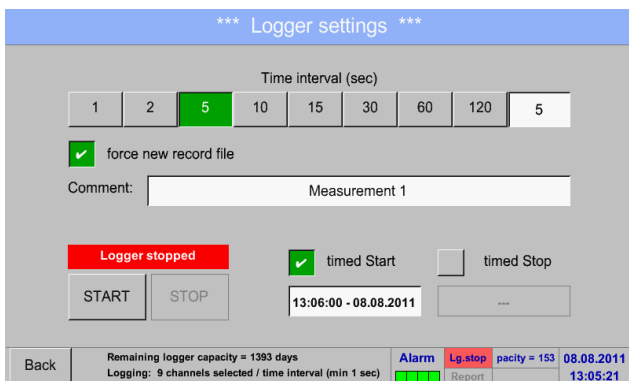

*** Logger settings ***

Time interval (sec)

1 2 5 10 15 30 60 120 5

force new record file

Comment: Measurement 1

Logger stopped

timed Start timed Stop

START STOP

13:06:00 - 08.08.2011

Back Remaining logger capacity = 1393 days Alarm Lg.stop pacity = 153 08.08.2011
Logging: 9 channels selected / time interval (min 1 sec) Report 13:05:21

By pushing the *timed Start* button and then the date/time description field below, the date and the start time can be set for a data logger recording.

Remark:

If the start time is activated, it will automatically be set at the current time plus a minute.

Main menu → Settings → Logger settings → timed Stop button

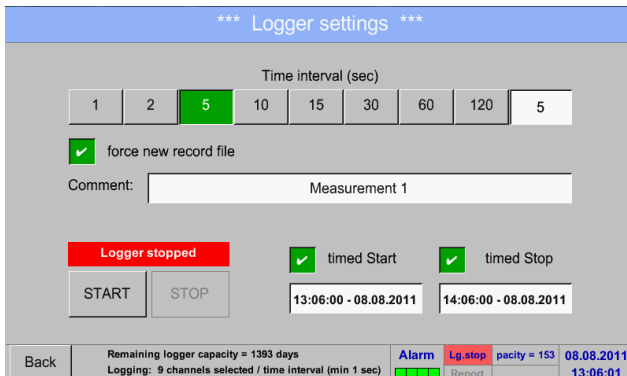

By pushing the *timed Stop* button and then the date/time description field below, the date and the stop time can be set for a data logger recording.

Remark:

If the stop time activated, it will automatically be set to the current time plus an hour.

Main menu → Settings → Logger settings → timed Start button/timed Stop button
→ Date/Time description field

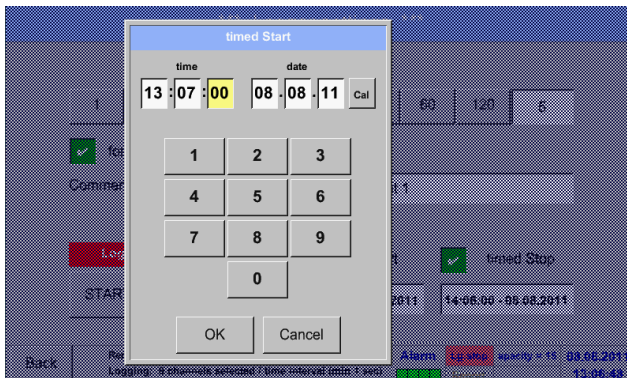

After pushing the *date/time description field* a window will appear where the yellow marked area of the time or date can always be set and changed.

Main menu → Settings → Logger settings → timed Start button/timed Stop button → Date/Time description field → Cal button

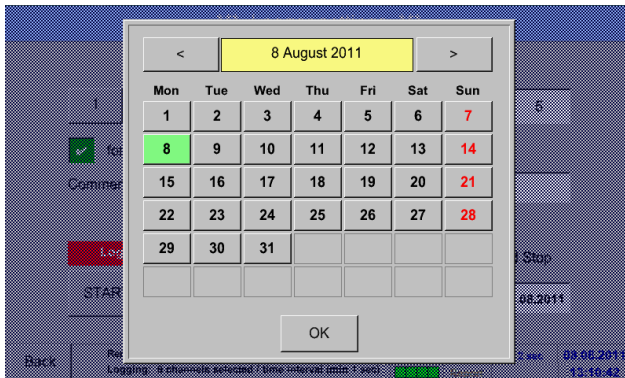

With the *Cal* button the desired date can be easily select from the calendar.

Main menu → Settings → Logger settings → Start button

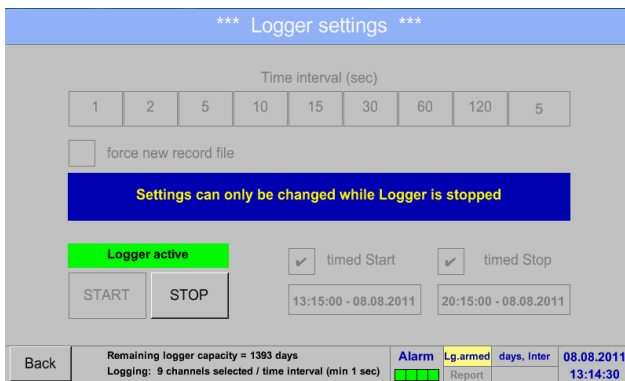

After the start and stop time activation and the created settings, the *Start* button will be pushed and the data logger is armed.

The data logger starts the recording at the set time!

Main menu → Settings → Logger settings → Start button/Stop button

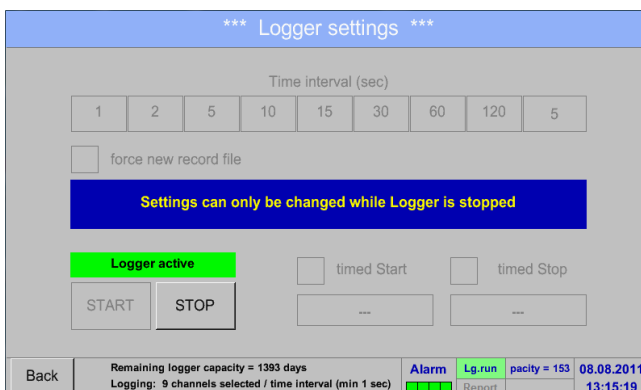

The data logger can be started without activated time settings, use the *Start* and *Stop* buttons for activate and disable. Left below there will be shown how many values are recorded and how long there still can be recorded.

Remark:

The settings cannot be changed, if the data logger runs.

Important:

If a new recording file should be created, the *force new record file* button must be activated. Otherwise, the last applied recording file is used.

9.5 Device settings

Main menu → Settings → Device settings

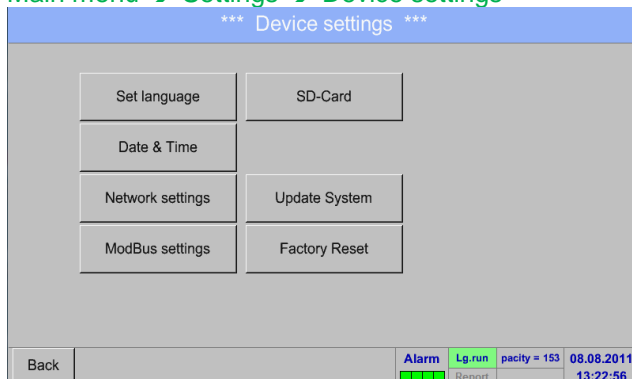

Overview of *Device settings*

9.5.1 Set language

Main menu → Settings → Device settings → Set language



Here you can select one of 12 languages for the DS 500.

Remark:
Currently only *German* and *English*!

9.5.2 Date & Time

Main menu → Settings → Device settings → Date & Time

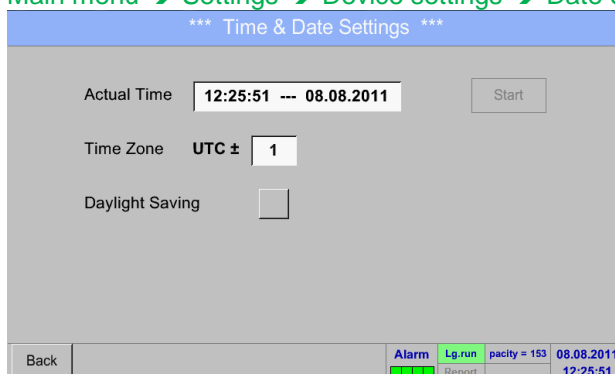

By pushing the *Time Zone* description field and enter the correct *UTC*, you can set the correct time all over the world.

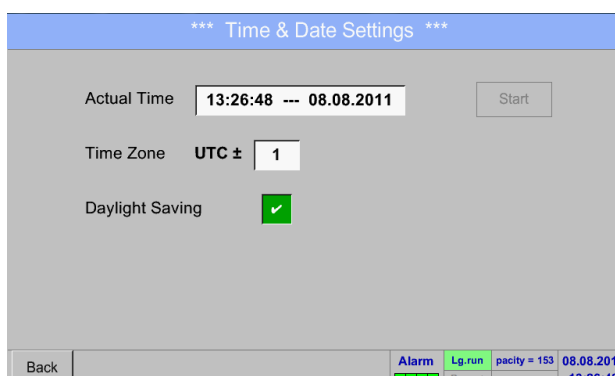

The summer and winter time switchover is realized by pushing the *Daylight Saving* button.

9.5.3 Network settings

Main menu → Settings → Device settings → Network settings

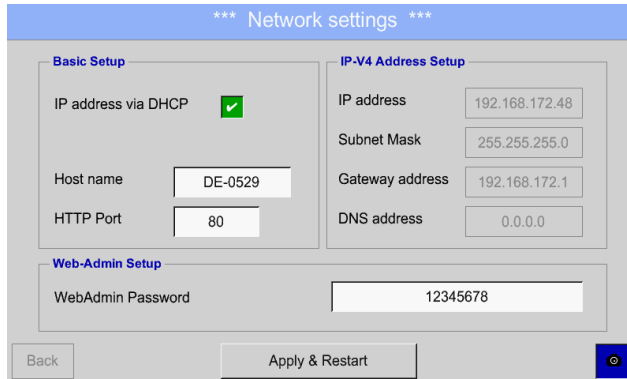

Here you can set up and made a connection, with or without *DHCP*, to a computer.

Remark:

With activated *DHCP* (green hook), the automatic integration of the DS 500 in an existing network is possible, without a manual configuration.

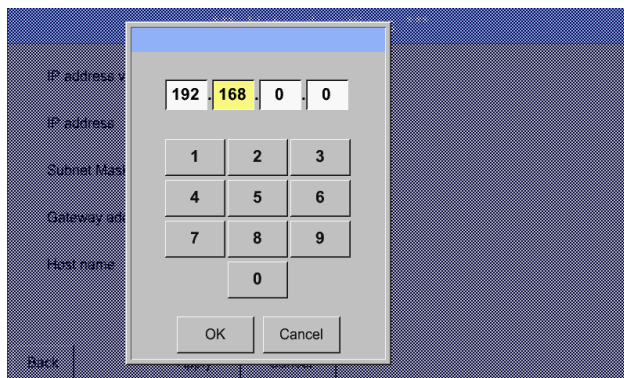

After pushing, for example the *IP address* description field, the command window appears, where in the selected yellow area a partial *IP address* can be entered manually.

The *Host name* can be entered or changed by pushing the description field.

Subnet Mask and Gateway address are entered in the same way!

Label *Host name*, see chapter 9.3.2.2 Label and setting the description fields!

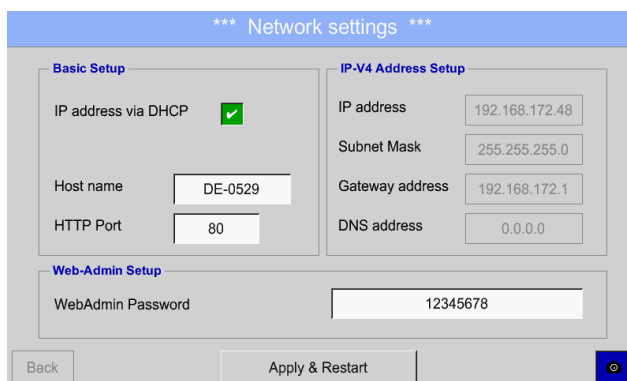

For example a *IP-Address* out of address range of the class C-Net

Remark:

Private Address range Class A-Net
10.0.0.0 bis 10.255.255.255
Private Address range Class B-Net
72.16.0.0 bis 172.31.255.255
Private Address range Class C-Net
192.168.0.0 bis 192.168.255.255
Subnetz Mask: e. g. 255.255.255.0

9.5.4 ModBus Slave

Not available for DS 500 mobile

9.5.5 Relay settings

Main menu → Settings → Device settings → SD-Card → Reset Logger Database

Main menu → Settings → Device settings → SD-Card → Erase SdCard

Main menu → Settings → Device settings → Relais-Settings

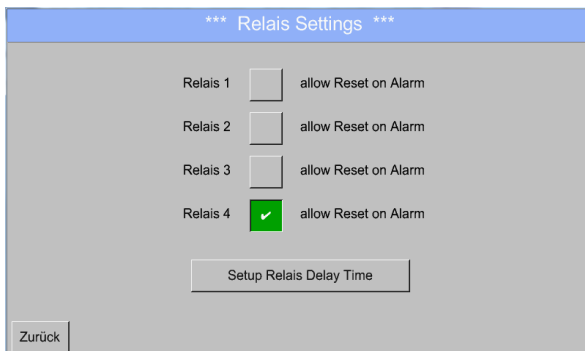

By activated *Relais* button, it is allowed / possible to turn off the corresponding alarm relays in the popup appearing in alarm case.

Setting is only possible in the password protected *Device Settings* menu.

Default values at delivery are **not allowed** .



In an alarm case e.g. here alarm 1 (Yellow) for channel A1 a popup will be displayed.

If in the Relay Settings, the turning off of Relay 1 was allowed by pressing Relay 1 button switches this off.

By confirming with OK the popup will be closed.

9.5.6 SD-Card

Main menu → Settings → Device settings → SD-Card → Reset Logger Database

Main menu → Settings → Device settings → SD-Card → Erase SdCard

Main menu → Settings → Device settings → SD-Card → Test SdCard

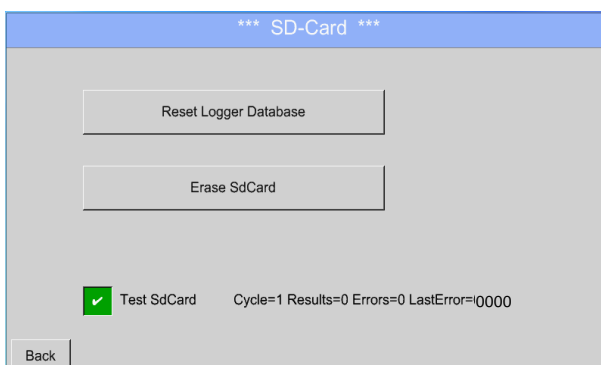

By pressing *Reset Logger Database* all actual stored data on SD-Card will be blocked for use in DS500. Nevertheless all data are still stored and available for external use only.

By pressing *Erase SdCard* all Data on the SD-Card will be deleted.

Selection/activation of "*Test Sd Card*" starts write-/read cycles. The testresults will be display as results, errors and last errors

9.5.7 Update System

Important:

Before updating the DS 500 the system settings should be secured either on a USB or the internal SD-Card!

9.5.7.1 Saving System settings

Home → Import / Export → Export System Settings

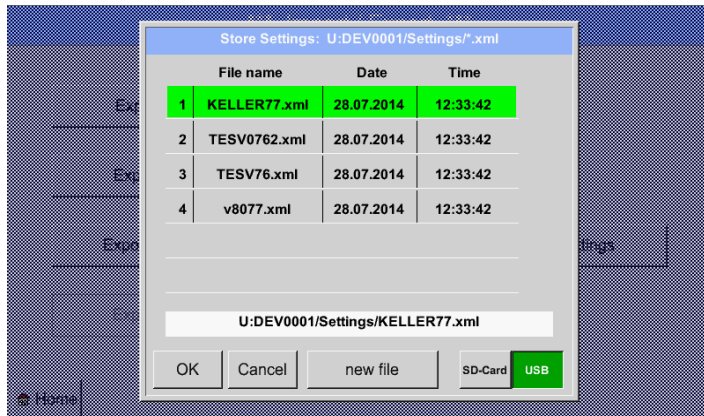

With Export system settings all existing sensor settings can be exported to a USB stick or to the internal SD card. It stores all sensor settings including recording-, alarm-, graphics-, value- and namedefinitions. Storing location could be selected using the buttons *SD card* or *USB*.

Either an new file could be created by pressing "*new file*" or an existing file overwritten by selecting a name from the list.

The data are stored after confirmation with *OK*.

Main menu → Settings → Device settings → Update System

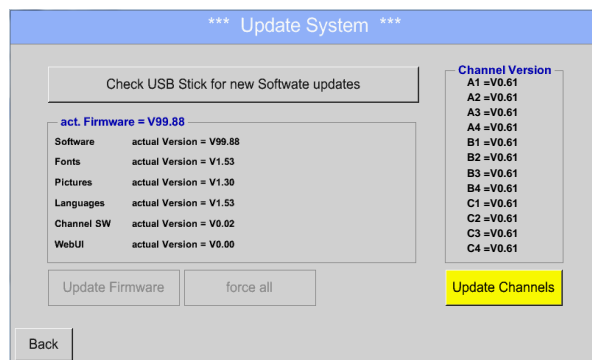

Overview of the **Update System** features

Remark:

The highlighted yellow fields shows, which kind of update is available!

9.5.7.2 Update FW (Main and channel)

Home → Settings → Device settings → System-Update

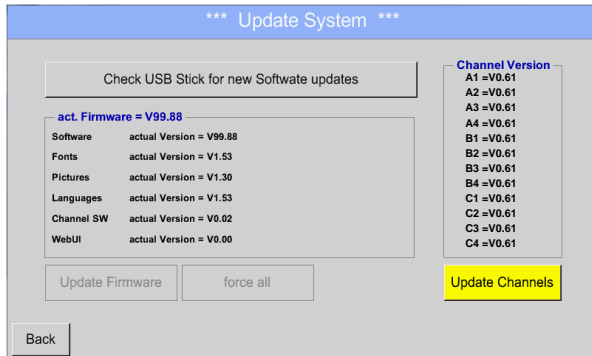

Overview of *System-Update*-Functions.

Home → Settings → Device settings → System-Update → check USB-Stick for new Updates

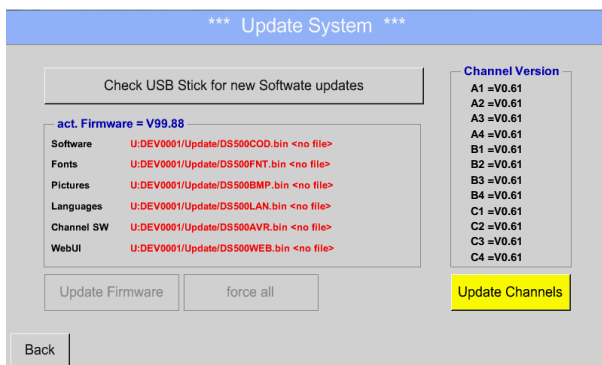

If after pressing the button "*Check USB Stick for new Software updates*" the following messages appear in the window, is the DS 500 is not properly connected to the USB flash drive or there are no files available.

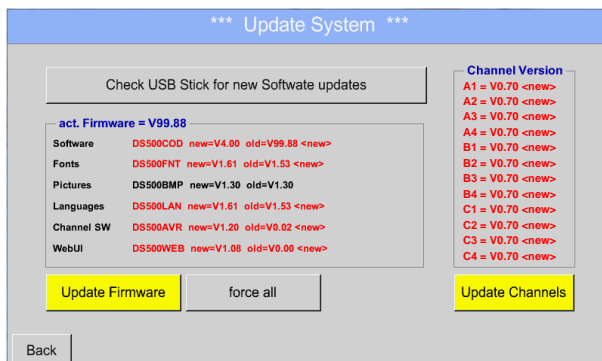

Is the DS 500 properly connected to the USB drive and there are new versions of the individual software parts available, then they are in red font and <new> marked.

If it is required to install an older software version, you have press the button "Force all".

Home → Settings → Device settings → System-Update → Update-Firmware

The update of DS 500 for all new SW parts starts.

Important:

If the *Reboot system* button appears after the update, it must be pushed to restart the DS 500!

Home → Settings → Device settings → System-Update → Update-Channels

The update of DS 500 channels starts.

Important:

If the *Reboot system* button appears after the update, it must be pushed to restart the DS 500!

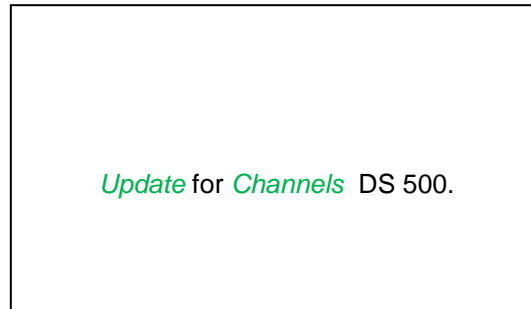
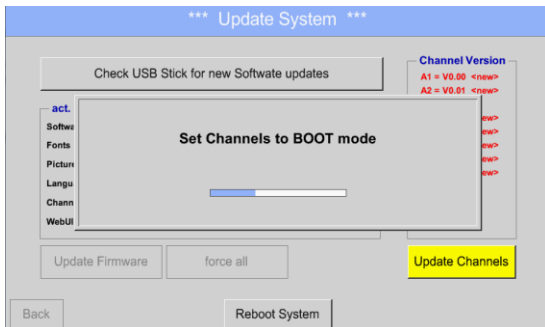

9.5.8 Factory Reset

Main menu → Settings → Device settings → Factory Reset

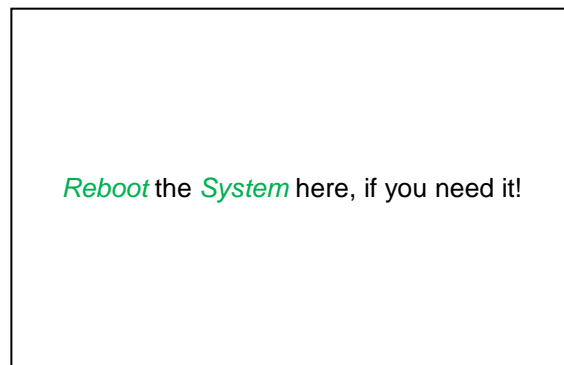
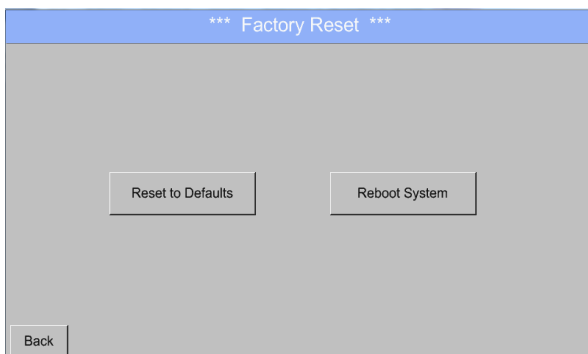

9.6 Report settings (optional)

Main menu → Settings → Report settings

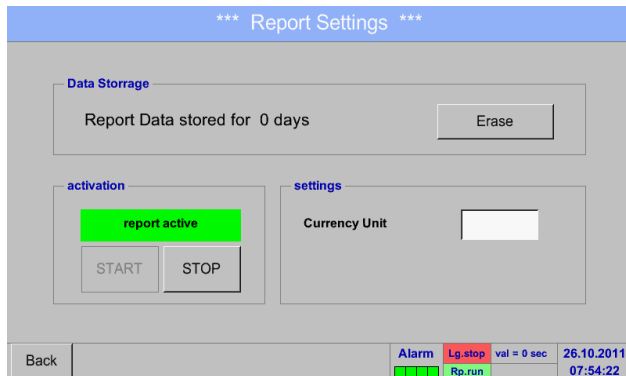

You can *Stop* and *Start* the **report** with the buttons.

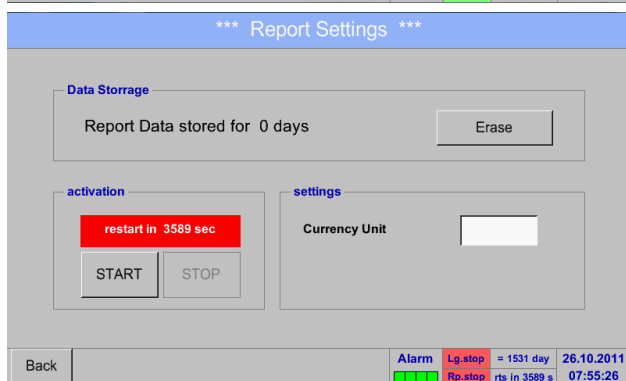

Remark:

After pushing the *Stop* button, the **report** will restart in one hour, if the *Start* button is not pushed, before!

Main menu → Settings → Report settings → Erase button

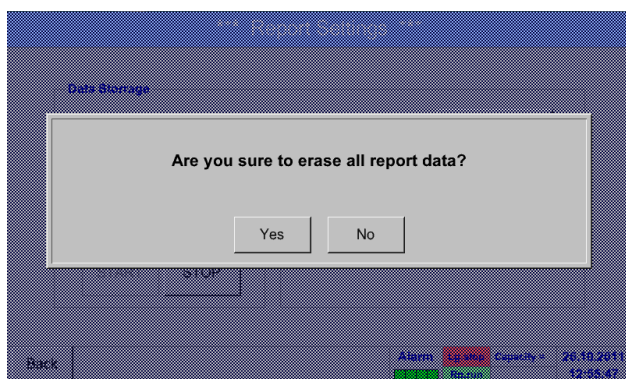

All stored *report data* can be erased by pushing *Yes*.

See also chapter [9.17 Export / Import](#)

Main menu → Settings → Report settings → Currency Unit description field

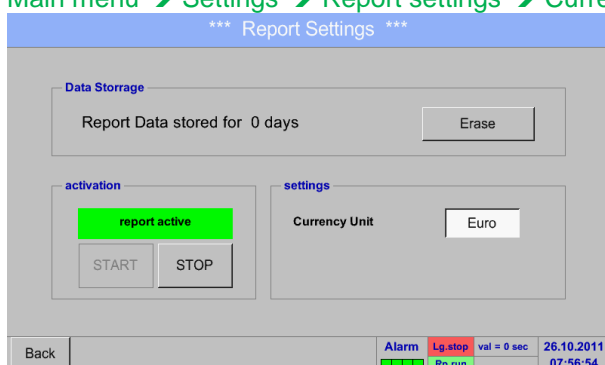

By pushing of the *Currency Unit* description field, a currency may be entered, which is applied to the **Consumption report** and the **cost settings**.

Remark:

Is no currency entered, the accordant fields remain empty.

See also chapter [9.15.1 Consumption report \(optional\)](#) and [9.15.2 Cost Settings \(optional\)](#)

9.7 Virtual Channels (optional)

The option „Virtual Channels“ offers 4 additional channels (no HW Channels) where it is possible to display calculations of each single HW-Channel, virtual channels and free defined constants as well. For each „Virtual Channel“ are 8 calculations each with of 3 operands and 2 operations possible.

Possible cases are calculation of:

- Specific performance of a compressor(s)
- Complete consumption of a compressor(or the sum of several compressors)
- Energycost etc.

An example for a specific performance calculation see chapter 12.2.6.6

9.7.1 Option „Virtual Channels“ activation

After purchasing of the option „Virtual Channels“ the functionality have to be activated first.

Main menu → Settings → about DS 500

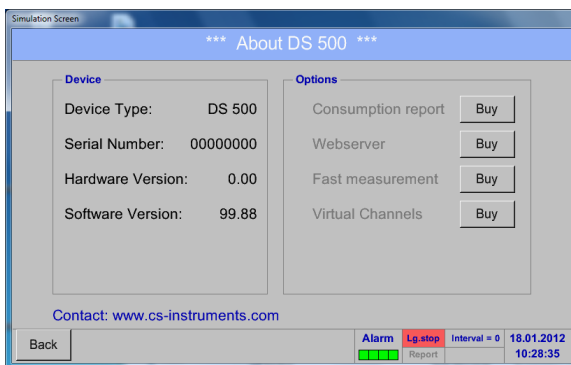

Please push the button Buy for „Virtual Channels“ and you will requested to insert the key-code received



Please enter the Key-Code in the text-field and activate the option by pushing the button **OK**.

9.7.2 Virtual Channels Settings

Main menu → Settings → Sensor Settings → Virtual Channels

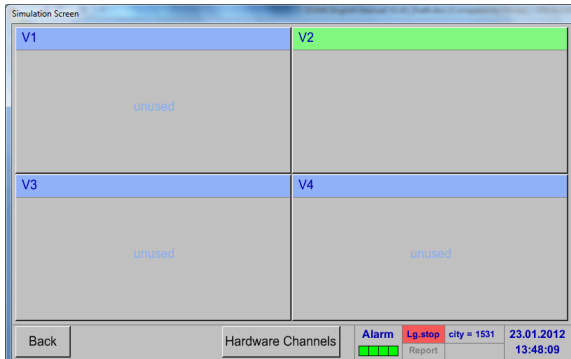

After pushing the button „*Virtual Channels*“ in the Sensor Settings menu an overview with the 4 available “*Virtual Channels*” is displayed.

Remark:

By default all channels are without settings.

9.7.3 Selection of Sensor-type

Main menu → Settings → Sensor Settings → Virtual Channels → V1

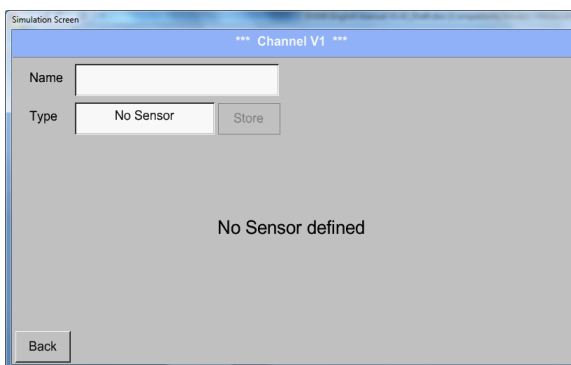

By pushing the description field *Type No Sensor* the list of sensor types appears (see next step).

Main menu → Settings → Sensor Settings → Virtual Channels → V1 → Type text field

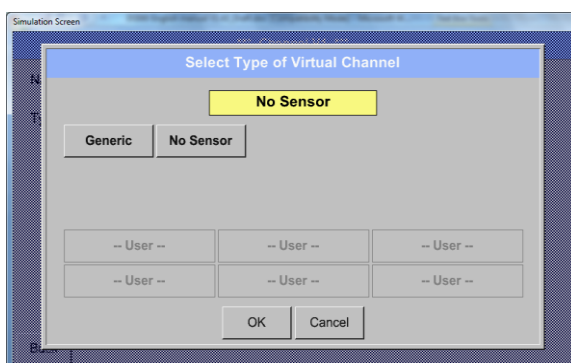

If still no sensor has been configured, the *Type No Sensor* appears.

By pushing the button **Generic** the virtual channel is selected.

Pushing the button **No Sensor** will reset the virtual channel.

Confirmation of selection is done by pressing the button **OK**.

Main menu → Settings → Sensor Settings → Virtual Channels → V1 → Name text field

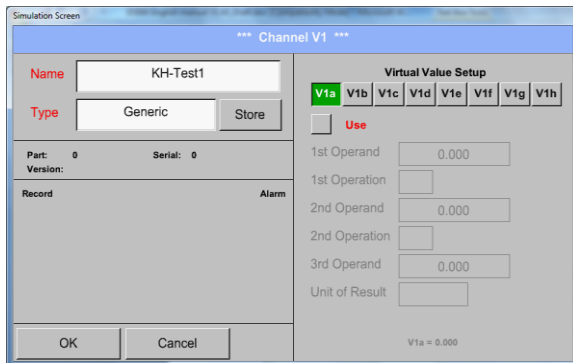

By pushing the Text field *Name* a Sensor name could be inserted..

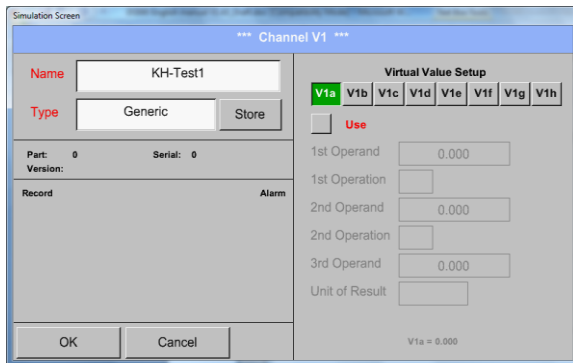

The button *Store* is implemented for storing of sensor settings (custom sensor) see [chapter 9.3.2.11](#)

9.7.4 Configuration of each single virtual value

Each virtual channel includes 8 individual calculated values where every value has to be activated separately.

9.7.4.1 Activation of a single virtual value

Main menu → Settings → Sensor Settings → Virtual Channels → V1 → V1a → Use

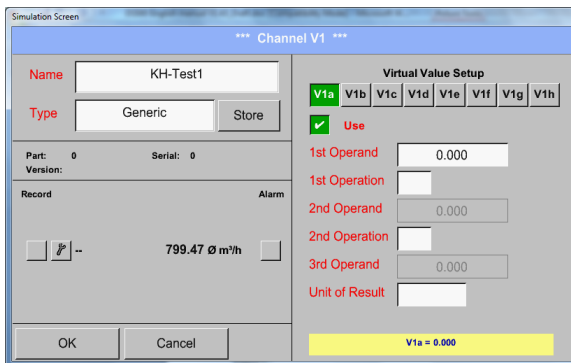

Every virtual value has to be activated by selecting the respective *Value-Button* e.g. *V1a* and pushing of the *Use Button*.

9.7.4.2 Definition of Operands

Main menu → Settings → Sensor Settings → Virtual Channels → V1 → 1stOperand

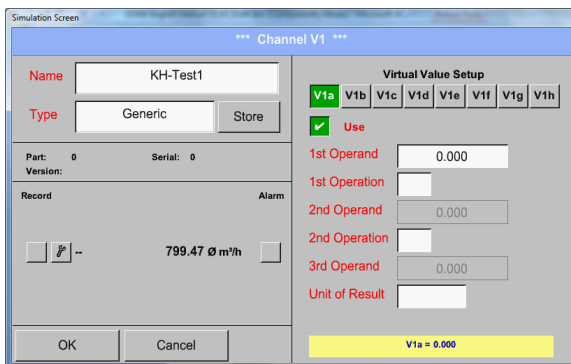

By accessing the text field *1st Operand* The list with all channels (HW and virtual channels) and const. Value appears.

Main menu → Settings → Sensor Settings → Virtual Channels → V1 → 1stOperand → A1

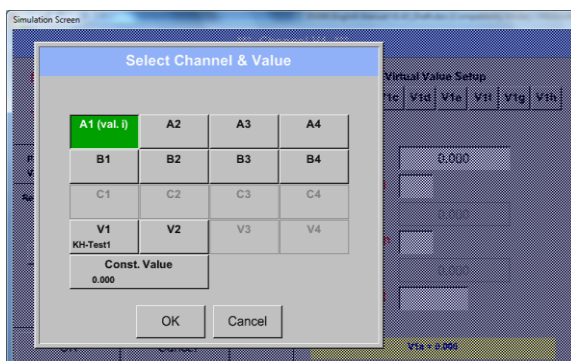

By pressing a button either for HW-, virtual channel or const. Value e.g. *A1* a list of all available measurement channels or measurement values will appear.

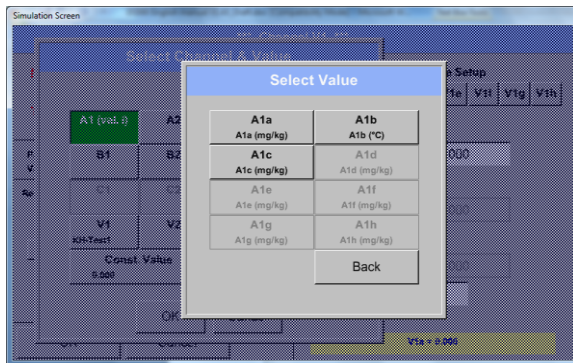

Pressing the respective channel button e.g. **A1b** will select the measurement channel

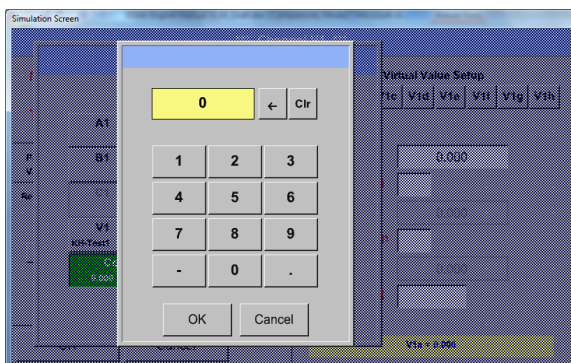

Pressing the button **const. Value** requests the input of the **const. Value** into the text field.

With button **OK** the value will validated

With the buttons **←** and **Clr** it is possible to correct the input.

Button **←** deletes the last figure
Button **Clr** clears the whole field

This approach is analogous to the other operands. (1st Operand, 2nd Operand and 3rd Operand) .

9.7.4.3 Definition of Operations

Main menu → Settings → Sensor Settings → Virtual Channels → V1 → 1st Operation

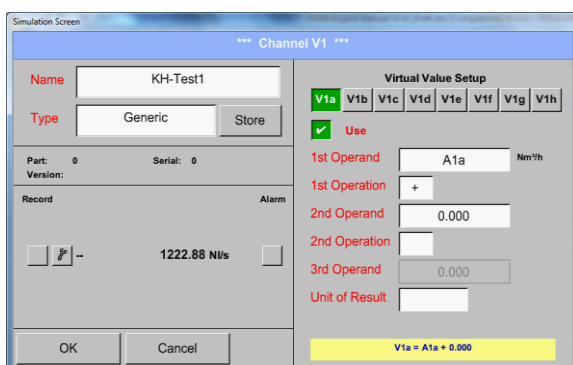

By accessing the text field **1st Operation** the list with all available operands appears.

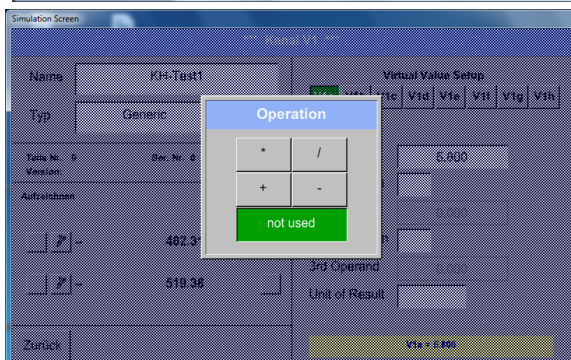

Selecting and validation of the operand by pressing the respective operand.

Pressing of the button **not used** deactivates the operation of the dedicated operand.

This approach is analogous for both operations (1st Operation and 2nd Operation)

9.7.4.4 Definition of Unit

Main menu → Settings → Sensor Settings → Virtual Channels → V1 → Unit of Result

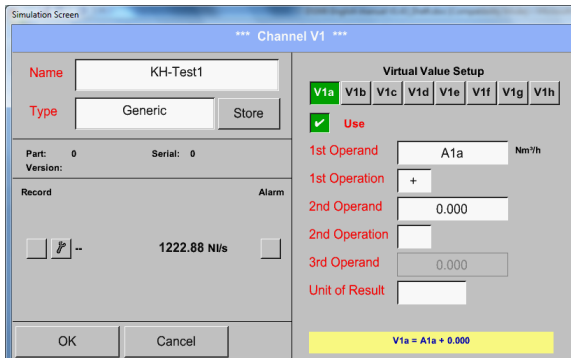

By accessing the text field *Unit of Result* the list with all available units appears

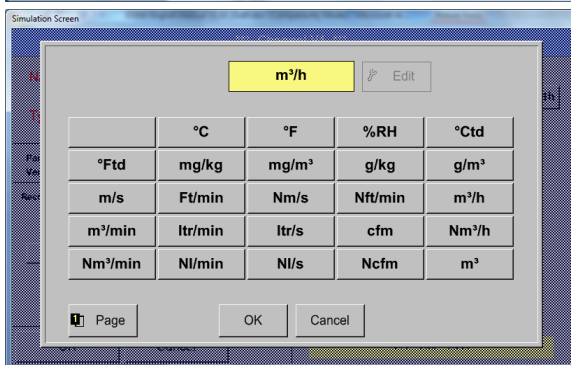

Please select the unit by pressing the respective button e.g. *m³/h*.
For validation of the unit please push the button *OK*
To move through the list please press the button *Page*.
In case the unit is **not** available it is possible to create a user defined unit.
Therefore please select one of the *User_X* buttons..

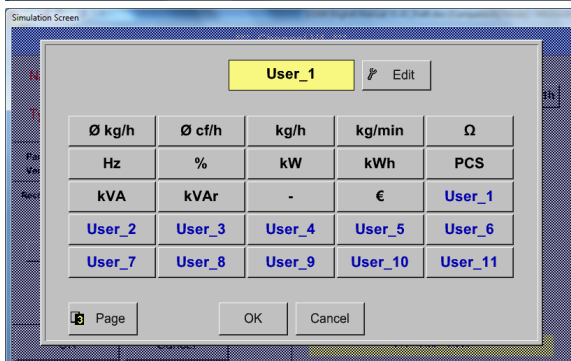

By pressing the button *Edit* you enter the menu for inserting the new Unit.

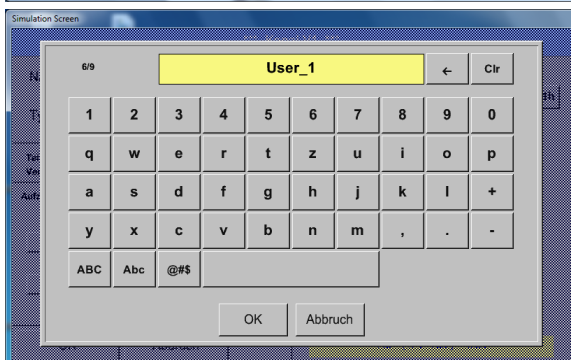

Then define the unit and confirm it with the button *OK*.

With the buttons *←* and *Clr* it is possible to correct the input.

Button *←* deletes the last figure
Button *Clr* clears the whole field

Important

Each calculation allows you the use of maximum 3 operands and 2 operations.

The calculation is then based on following formula:

Example:

V1a = (1st Operand 1st operation 2nd Operand) 2nd operation 3rd Operand

V1a = (A1c – A2a) * 4.6

9.7.4.5 Value name, resolution of decimal places and recording of values

Main menu → Settings → Sensor Settings → Virtual Channels → V1 → Tool-Button

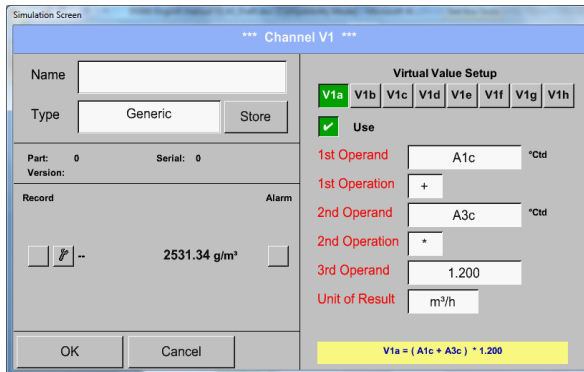

The *Resolution* of the decimal places, the *Short Name* and *Value Name* are found under the **Tool button**

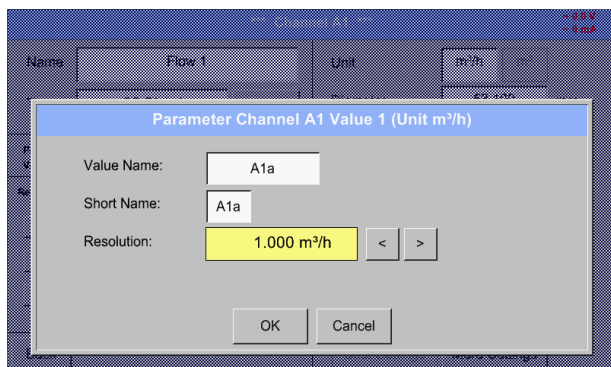

For the recorded *Value* there can be entered a *Name* with 10 characters and later in menu item *Graphics/Real time values* it is easier to identify it.
The *Resolution* of the decimal places is simply adjustable by pushing right and left (0 to 5 decimal places).

Main menu → Settings → Sensor Settings → Virtual Channels → V1 → Record Button

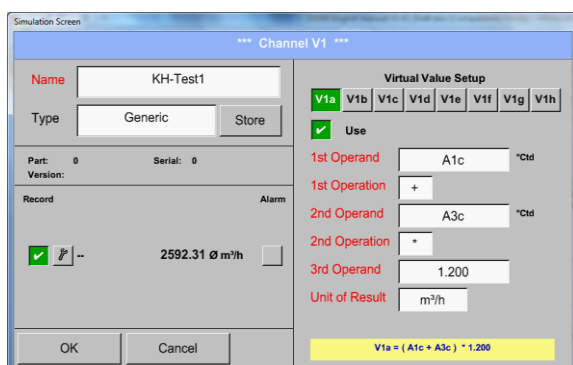

Use the *Record* buttons to select the measurement data that will be stored by **activated data logger**.

Attention:

Before the selected measurement data are recorded, the data logger must be activated after the settings(See chapter 9.4 Logger settings (data logger)).

See also chapter 9.3.2.3 Name the measurement and 9.3.2.4 Recording measurement data

9.7.4.6 Calculation Example „Specific Performance“

As an example we assume a compressor system with 5 single compressors.

The consumption measurements are done with consumption sensors VA400 at the inputs A1 - A4 & B1 and an electric meter at input B2.

Calculated are the complete consumption of air and energy as well as the "specific performance" of the entire system .

Main menu → Settings → Sensor Settings → Virtual Channels → V1 → V1a → Use

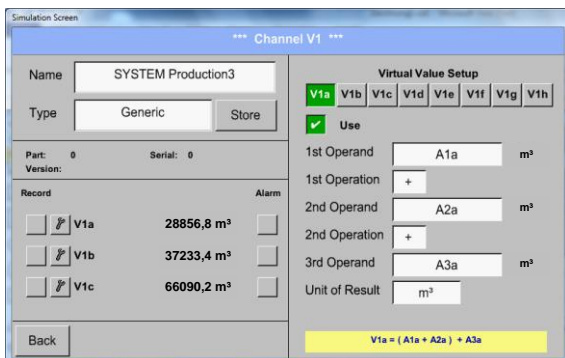

Record	Value	Alarm
V1a	28856,8 m³	<input type="checkbox"/>
V1b	37233,4 m³	<input type="checkbox"/>
V1c	66090,2 m³	<input type="checkbox"/>

Selection and Input of the operands and operations see chapter [9.7.4.2](#) and chapter [9.7.4.3](#).

Result in **V1a** is the sum of consumption sensor **A1 + A2 + A3** see range "result".
For this example it is **28856,8 m³**

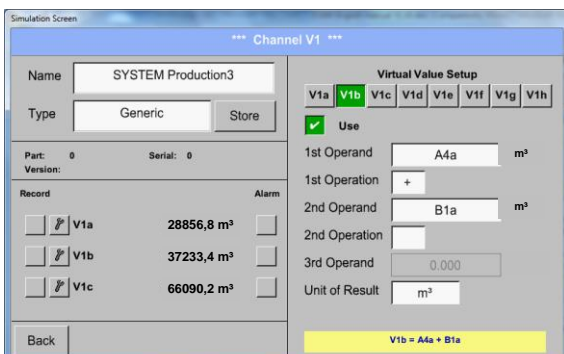

Record	Value	Alarm
V1a	28856,8 m³	<input type="checkbox"/>
V1b	37233,4 m³	<input type="checkbox"/>
V1c	66090,2 m³	<input type="checkbox"/>

Selection and Input of the operands and operations see chapter [9.7.4.2](#) and chapter [9.7.4.3](#).

Result in **V1b** is the sum of consumption sensor **A4 + B1** see range "result".
For this example it is **37233,4 m³**

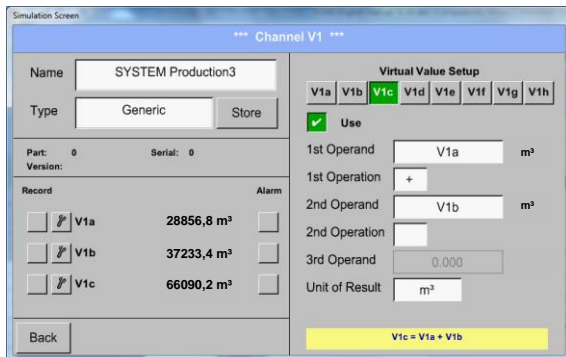

Simulation Screen
*** Channel V1 ***

Name: SYSTEM Production3
Type: Generic

Part: 0 Serial: 0

Record: V1a 28856,8 m³, V1b 37233,4 m³, V1c 66090,2 m³

Virtual Value Setup
V1a V1b V1c V1d V1e V1f V1g V1h
Use: Use
1st Operand: V1a m³
1st Operation: +
2nd Operand: V1b m³
2nd Operation:
3rd Operand: 0.000
Unit of Result: m³
V1c = V1a + V1b

Selection and Input of the operands and operations see chapter [9.7.4.2](#) and chapter [9.7.4.3](#).

1.1.1 Result in V1c is the complete consumption with V1a + V1b see range "result".

For this example it is *66090,2 m³*

Alternatively the complete consumption could be calculated already in V1b, this using

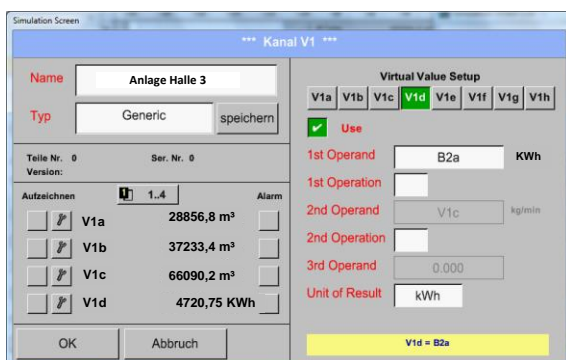

Simulation Screen
*** Kanal V1 ***

Name: Anlage Halle 3
Typ: Generic

Teil Nr. 0 Ser. Nr. 0

Aufzeichnen: 1.4

Record: V1a 28856,8 m³, V1b 37233,4 m³, V1c 66090,2 m³, V1d 4720,75 kWh

Virtual Value Setup
V1a V1b V1c V1d V1e V1f V1g V1h
Use: Use
1st Operand: B2a kWh
1st Operation:
2nd Operand: V1c kg/min
2nd Operation:
3rd Operand: 0.000
Unit of Result: kWh
V1d = B2a

For a complementation we added in V1d the total sum of consumed energy.

Read out of electric meter at input B2.

V1c → complete Air consumption

V1d → energy consumption

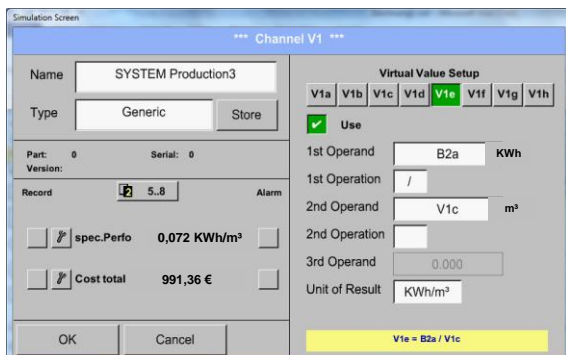

Simulation Screen
*** Channel V1 ***

Name: SYSTEM Production3
Type: Generic

Part: 0 Serial: 0

Record: 5.8

Record: spec.Perfo 0,072 kWh/m³, Cost total 991,36 €

Virtual Value Setup
V1a V1b V1c V1d V1e V1f V1g V1h
Use: Use
1st Operand: B2a kWh
1st Operation: /
2nd Operand: V1c m³
2nd Operation:
3rd Operand: 0.000
Unit of Result: kWh/m³
V1e = B2a / V1c

Calculation of the *specific. Perfor.* Is done in V1e with $V1e = B2 / V1c$

For this example it is *0,072 kWh/m³*

Cost calculation in V1f with $V1f = B2 * 0.21$

For this example it is *991,36 €*

Due to more as 4 values used in virtual channel V1 the result range is splitted into 2 pages. To move between the pages please press the *page button*

9.8 Analog Total (optional)

The Option „Analog Total“ offers the possibility of a consumption measurement also for sensors with analogue outputs e.g.: 0-1/10/30V and 0/4 – 20mA.

9.8.1 Option „Analog Total“ activation

After purchasing of the option „Analog Total“ the functionality have to be activated first.

Hauptmenü → Einstellungen → über DS 500



Please push the button Buy for „Virtual Channels“ and you will be requested to insert the key-code received

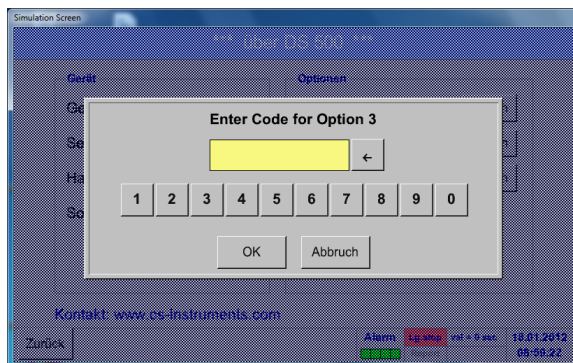

Please enter the Key-Code in the text-field and activate the option by pushing the button **OK**.

9.8.1.1 Selection of sensor type

See also chapter [9.3.7 Configuration of analogue Sensors](#)

Main menu → Settings → Sensor Settings → A1

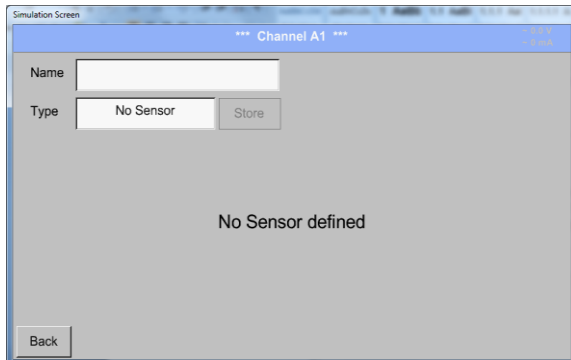

By pushing the description field **Type No Sensor** the list of sensor types appears (see next step).

Main menu → Settings → Sensor Settings → A1 → Type Textfield

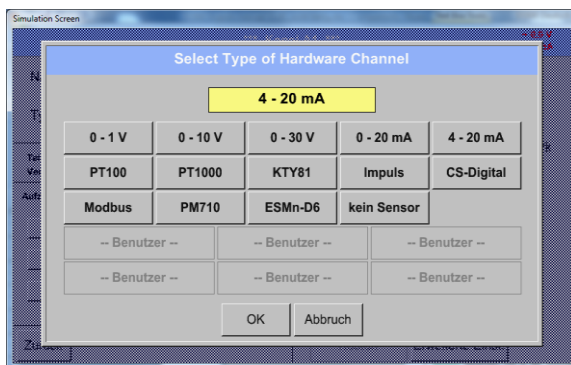

If still no sensor has been configured, the **Type No Sensor** appears.

By pushing the button of the required sensor button e.g. 4 -20mA the sensor is selected. Pushing the button **No Sensor** will reset the selection.

Confirmation of selection is done by pressing the button **OK**.

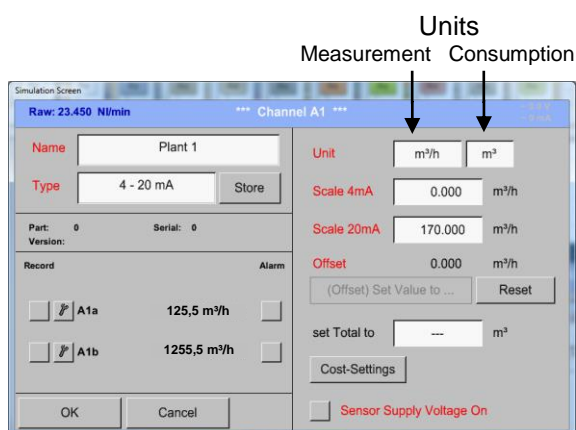

Selection of the units by pushing the text fields for the corresponding measurement and consumption units.

In addition, you can push the **scale buttons** for the min. and max. scaling values and set the measuring range.

Here we have **0 m³/h** for 4 mA and **170m³/h** for 20mA

Confirmation of the inputs by pushing button **OK**

Remark:

The text field „Unit-Consumption“ is only editable in case of measurement values(Units) with volume per time unit and thus also the consumption calculation.

For labeling and setting of the description fields see also chapter [9.3.2.2 Label and set the description fields](#)

9.9 Chart

Main menu → Chart

Attention:

In the **Chart** there can be represented only records that have already finished!

Current records can be seen in **Chart/Real time values**.

(See chapter 9.10 Chart/Real time values)



Running measurement, there are no values represented!

Zoom and scroll options in the time domain of the **Chart**:



Maximal an entire day can be represented (24h).



The smallest possible range is represented, depending on the time interval of the recording.

Additional zooming and scrolling options in **Chart** and **Chart/Real time values**:

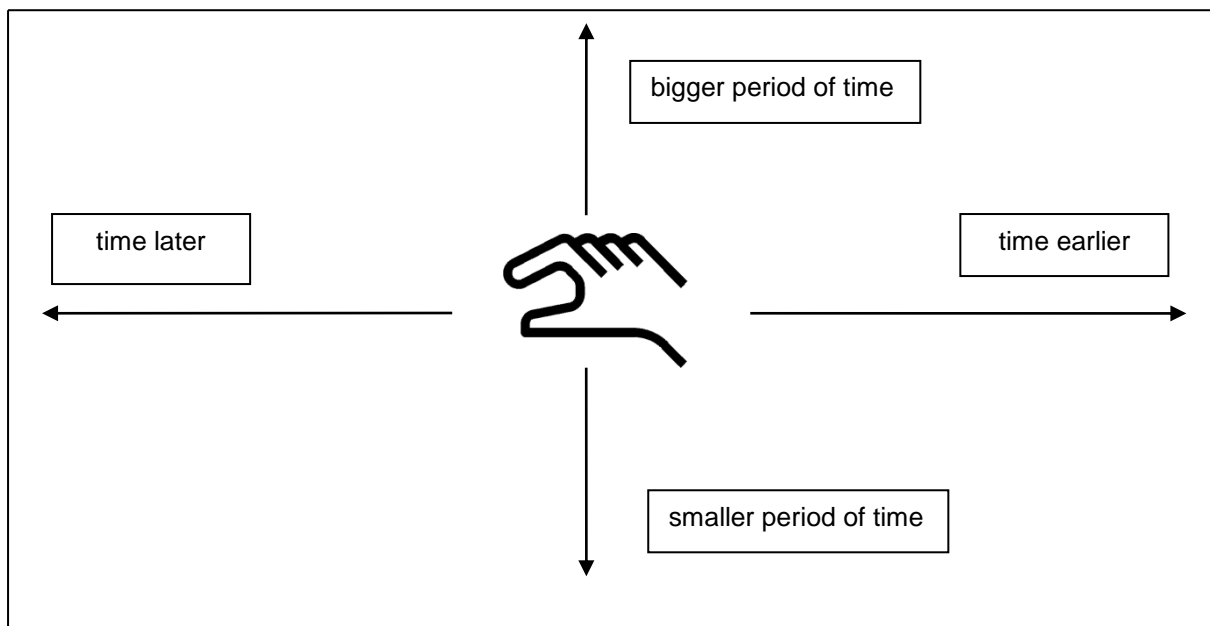

Main menu → Chart → Date description field

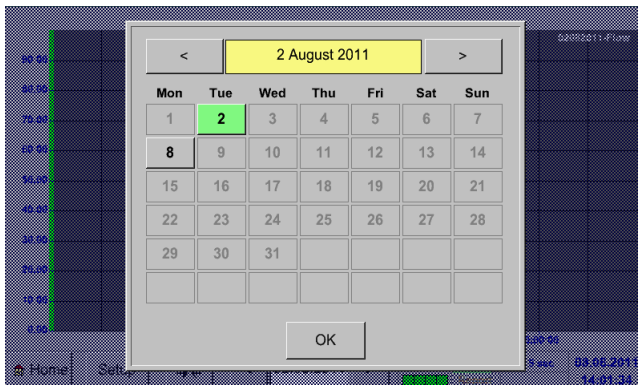

By pushing the **date** description field (center bottom) the calendar, from which the appropriate date can be selected conveniently, appears.

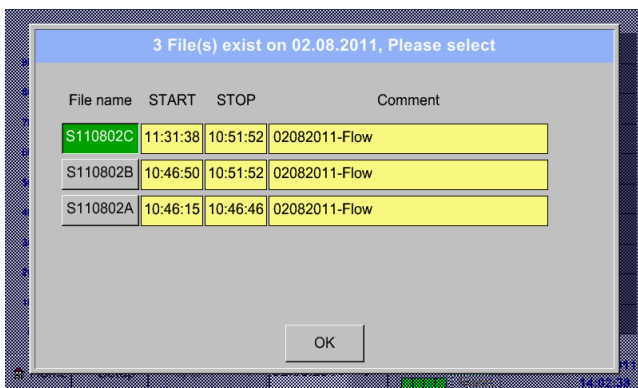

Stored measuring data can be select here by **time** (**START** and **STOP**), **Comment** and **File name** (contains English date).

Main menu → Chart → Setup

In the **Setup**, you can make up to four different y-axis labels and in addition choose a **Unit**, the grid (**min**, **max**, **step**) and several channels (**Plots**) and a **Colour**.

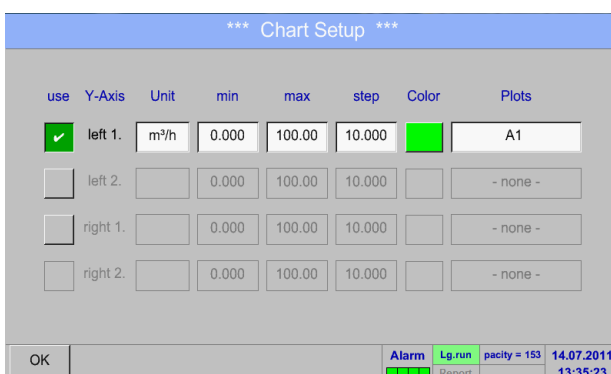

1. The y-axis **left 1** is already enabled, you can choose a **Colour** for it.

Remark:

Grid setting is already possible at this point, but later when a record is selected it is more reasonable!

Main menu → Chart → Setup → Unit description field



2. Select the *Unit* of the represented recording from the menu.

Main menu → Chart → Setup → Plots description field

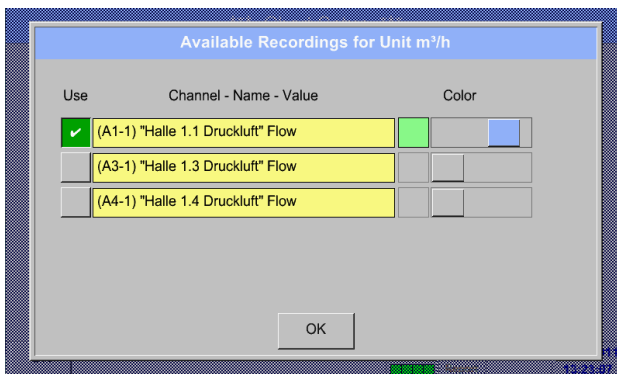

3. Now, you can choose the desired recording and colour intensity (in *Colour*).

Main menu → Chart → Setup

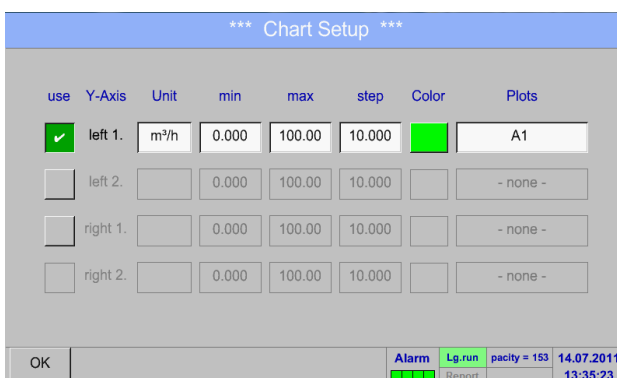

4. Now, the grid can be set with *min*, *max*, and *step*.

Main menu → Chart → Setup → Plots description field

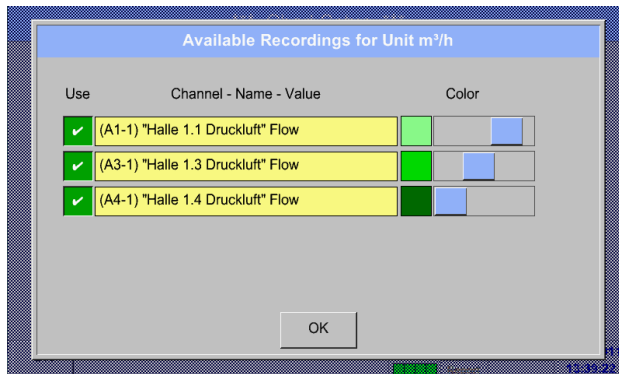

5. Several recordings with the same unit can be represented in one y-axis, with the help of various colour intensities.

Main menu → Chart → Setup

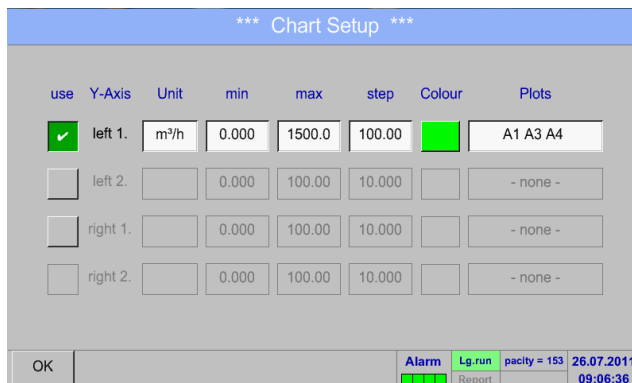

6. The *Plots* description field shows on what channel the measured data were recorded and there can be seen how much recordings on one y-axis are represented.

In the same way the remaining y-axes can be labelled!

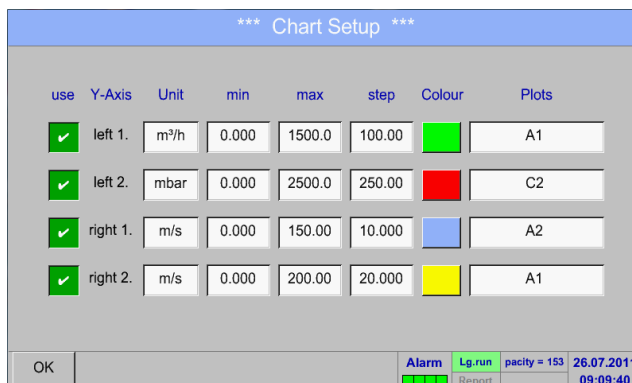

Four different grid settings with various *Units* and *Colours*.

Main menu → Chart



9.10 Chart/Real time values

Main menu → Chart/Real time values

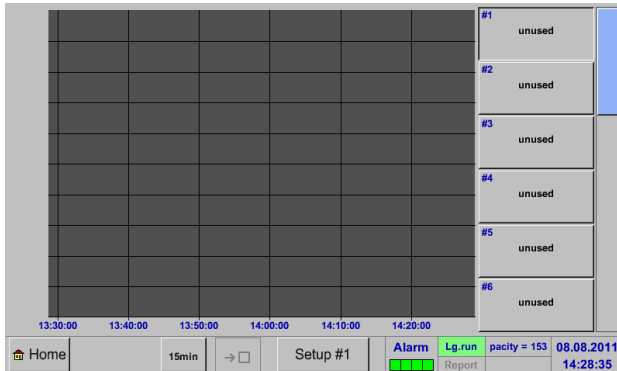

One or more channels for the recording and presentation of measured data can be selected here, such as a dewpoint sensor or several different sensors.

After pushing this button currently recorded measurement data in the current time range are represented.

Quick access to predefined time periods 24 h, 8 h, 1 h, 15 min and 2 min. At the push of a button the chart for the selected time range is displayed.

Main menu → Chart/Real time values → Setup #1 - #12

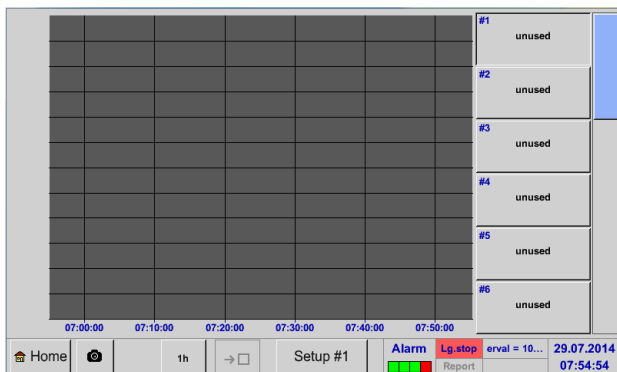

In this menu item, up to twelve channels (depending on the version of the DS 500) can be activated at the same time and viewed in *Main → Chart/Real time values*.

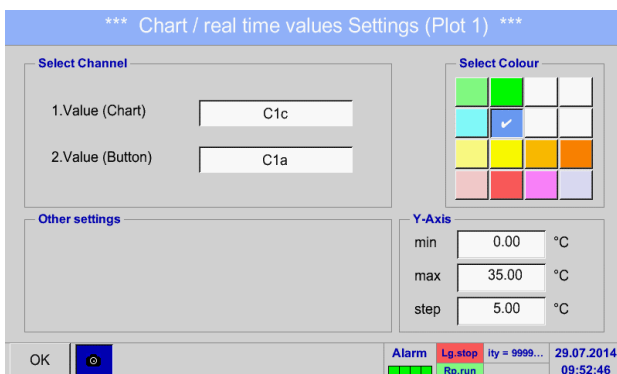

Here the channel C1 chosen.

For each channel, you can select a value to be represented in the *Chart* and one to display (*2. values*).

In addition, it can be set, like in *Main → Chart*, a *colour* and the grid (*min, max, step*) of the y-axis.

Main menu → Chart/Real time values

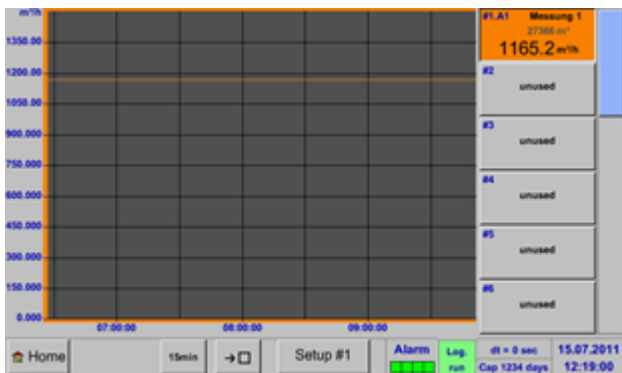

Channel A1:

Elected the flow as *Chart* and consumption as *2. values* (number with the smaller font size) and the *colour* orange.

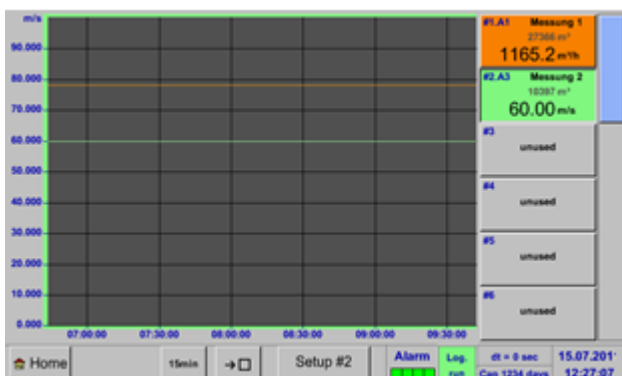

If several channels are clogged (here: 2 channels), all charts will be represented. But there is only the y-axis of the selected channel represented (here: Setup #2).

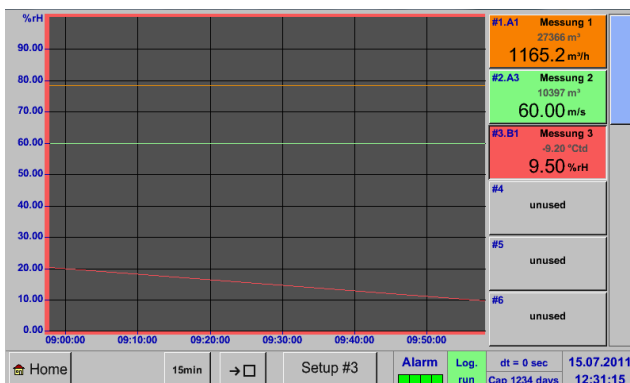

If there is no grid entered in the setup, *min* will be 0, *max* 100 and *step* 10 (Setup #3).

In the same way the remaining setups can be set!

Main menu → Chart/Real time values → Button #1 -#12

By activation of button # 1 - # 12, it is possible to change the setup of the corresponding graphic, see description above, or by a further press to switch off or back the graphic.



9.11 Channels

Main menu → Channels

A1 Hall 1.1 comp. air	A2 Hall 1.2 comp. air	A3 Hall 1.3 comp. air	A4 Hall 1.4 comp. air
<input checked="" type="checkbox"/> A1a 1165.2 m³/h	A2a 0.8 m³/min	<input checked="" type="checkbox"/> A3a 79.1 m³/h	A4a 282 m³/h
<input checked="" type="checkbox"/> A1b 27366 m³	<input checked="" type="checkbox"/> A2b 8174 m³	<input checked="" type="checkbox"/> A3b 10397 m³	<input checked="" type="checkbox"/> A4b 10463 m³
<input checked="" type="checkbox"/> A1c 180 m/s	A2c 90 m/s	A3c 60 m/s	A4c 120 m/s
B1 Hall 2.1 dewpoint	B2 Hall 2.2 dewpoint	B3 Hall 2.3 consumpt.	B4 Hall 2.4 consumpt.
<input checked="" type="checkbox"/> B1a -9.2 °Ctd	B2a -45.7 °Ctd	B3a 93 m³/h	B4a 174 m³/h
<input checked="" type="checkbox"/> B1b 9.5 %RH	B2b 0.25 %RH	<input checked="" type="checkbox"/> B3b 3617 m³	<input checked="" type="checkbox"/> B4b 96483 m³
B1c 22 °C	B2c 22.0 °C	B3c 50 Hz	B4c 100 Hz
C1 Hall 3.1 comp. air	C2 Hall 3.2 comp. air	C3 Hall 3.3 temp.1	C4 Hall 3.4 temp.2
<input checked="" type="checkbox"/> Val 14.6 bar	<input checked="" type="checkbox"/> Val 1653 mbar	<input checked="" type="checkbox"/> Val 167.3 °C	<input checked="" type="checkbox"/> Val 127.6 °C

Back Alarm Lg.run pacity = 153 08.08.2011 15:04:10

The overview of *Real time values* shows the current measured values of all connected sensors.

Exceeds or falls below the set alarm limits, the respective measured value flashes yellow (*alarm 1*) or red (*alarm 2*).

Main menu → Real time values → A1

*** Channel A1 *** ~ 0.0 V ~ 0 mA

Name	Hall 1.1 comp. air	Unit	m³/h m³
Type	CS-Digital Store	Diameter	53.100 mm
Part: 0	Serial: 1	Gas Constant	Air (287.0) J/Kg*k
Version: Max Velocity 92.700 m/s		Ref. Pressure	1000.000 hPa
Record	Alarm	Ref. Temp.	20.000 °C
<input checked="" type="checkbox"/> Flow 1165.2 m³/h	<input type="checkbox"/>	counter	0 m³
<input checked="" type="checkbox"/> Consump. 27366 m³	<input type="checkbox"/>	4mA = 0.000 m/s	20mA = 92.700 m/s
<input checked="" type="checkbox"/> Velocity 180 m/s	<input type="checkbox"/>		

Back Cost-Settings More-Settings

Each channel can be selected and the settings viewed and checked, but no changes can be made here.

Remark:
Please, make changes in the *Settings!*

9.12 Real time values

Main menu → real time values

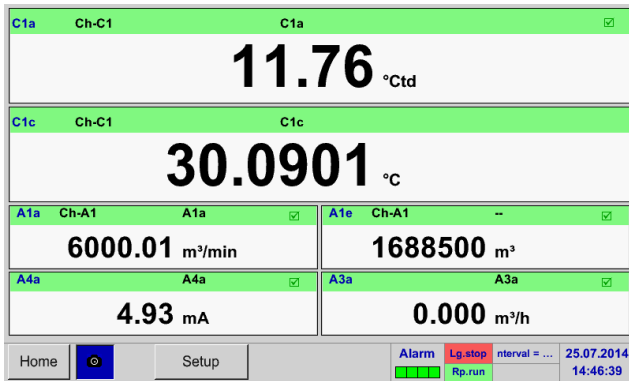

The view *Real time values* allows to display of 1 to 10 free definable measurement values.

By exceeding the upper- or lower alarm levels the respective measurement value flashes yellow for *Alarm-1* or red for *Alarm-2*.

Remark:

Changes for display settings have to be done in the *Setup* menu!

Main menu → real time values → Setup next Layout

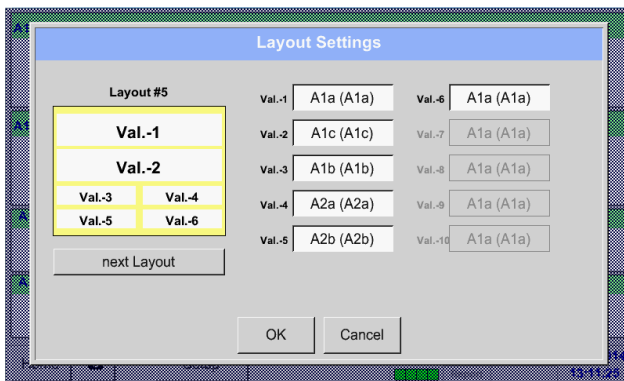

Here, by pressing *next Layout*–button it is possible to select the wanted layout.

You can choose between 7 different layouts showing 1-10 measurements. see below.

The values to be displayed could be selected in the *Val.1 to Val.10* description fields.

Different variants:

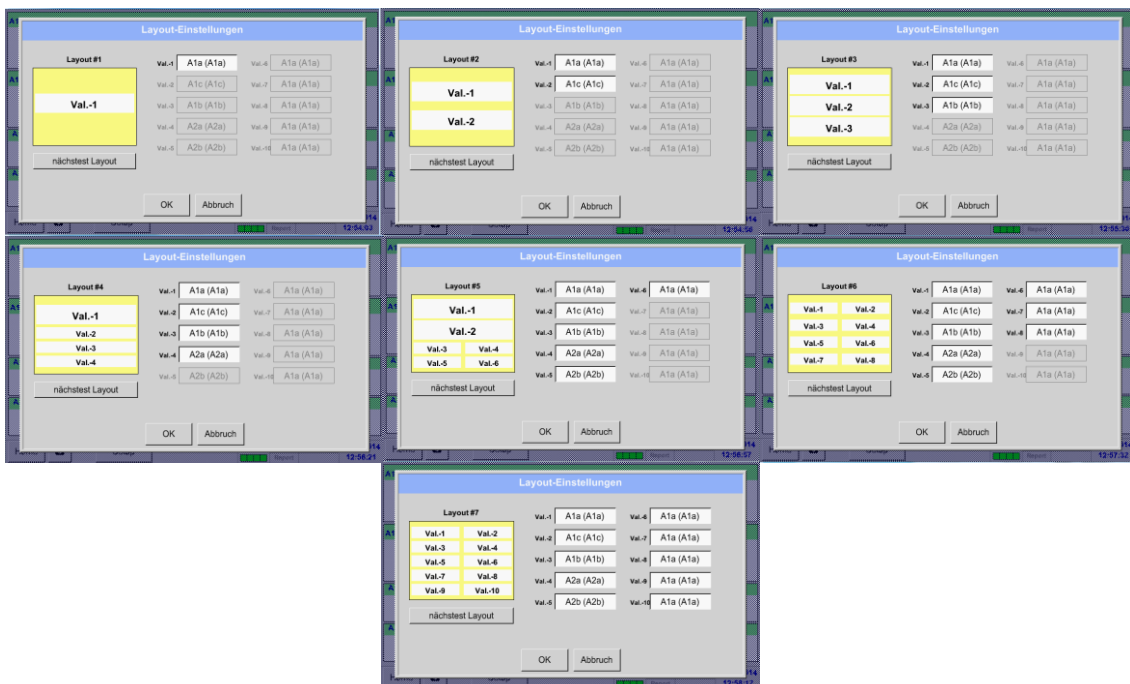

9.13 Alarm overview

Remark:

For DS500 mobile only the alarm-warnings on the display are available, alarm-relays are not accessible.

Main menu → Alarm overview

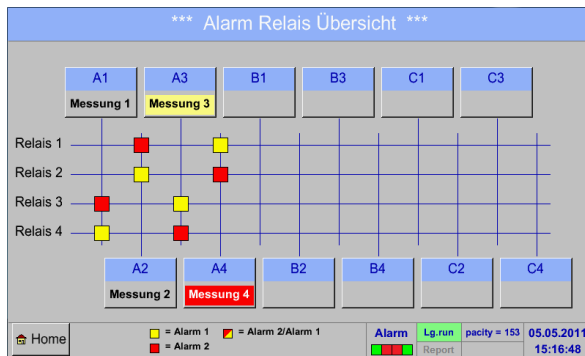

In the Alarm overview, you can immediately see whether there is an *alarm 1* or *alarm 2*. You can see also in other menu items: *Main* → *Real time values* and *Main* → *Settings* → *Sensor settings*. The channel name will appear yellow invers (*alarm 1*) or inverse red (*alarm 2*). In addition, you can see which relay had been set for the channel as the *alarm 1* or *alarm 2*. This is indicated by the yellow and red or red/yellow squares on the intersections between measuring channel and relay.

HERE: *Alarm1* for channel A3 and *alarm 2* for channel A4

Main menu → Alarm Overview → A1

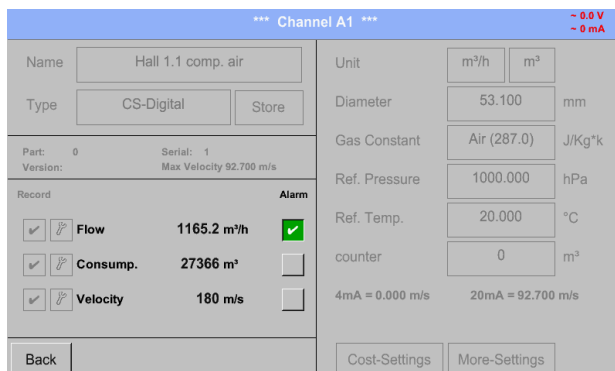

Like in *Main* → *Real time values*, individual channels can be selected here, to detect which and how much the value has exceeded or below the alarm range.

Remark:

The alarm parameters can be set and/or modified here.

9.14 Further setting options

9.14.1 Set backlight

Main menu → Settings → Set backlight

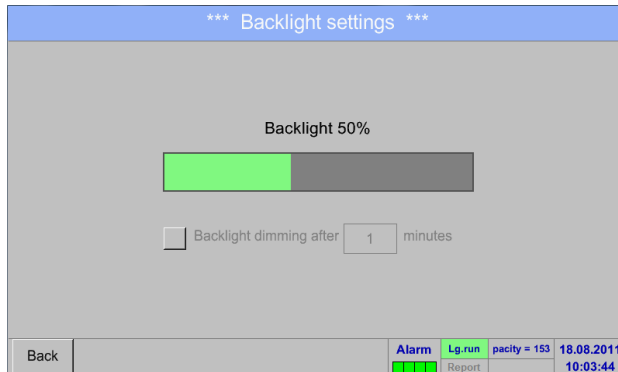

Here you adjust the desired *Backlight* (15-100%) of the display directly.

e.g. *Backlight* to 50 %

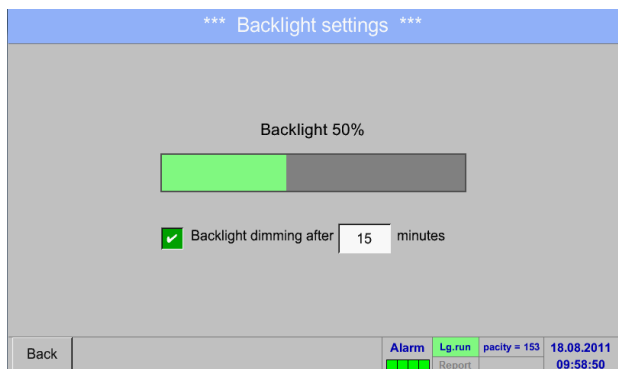

With the help of the *Backlight dimming after* button, after a definable time interval (here after 15 minutes), the *Backlight* can be reduced to the minimum.

As soon as the dimmed screen is operated again, the *Backlight* is committed automatically on the last set value before dimming.

Remark:

At the first touch, the *Backlight* in our example is reset to 50%, after that a "normal" function operation is possible.

Important:

If the *Backlight dimming after* button is not activated, then the *Backlight* stays permanently on, in the currently set brightness.

9.14.2 Calibrate touch-screen

Main menu → Settings → Touchscreen calibration

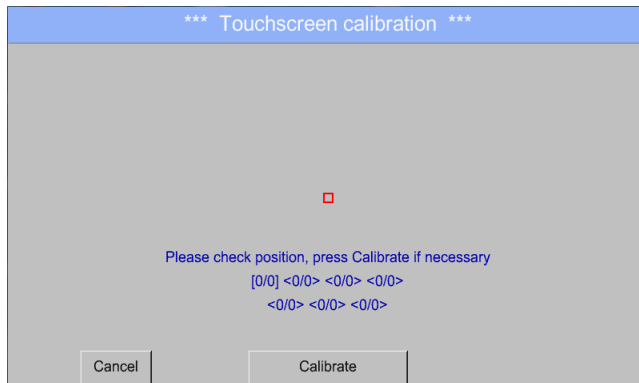

If necessary, the touch-screen calibration can be changed here.

Push **Calibrate** and it appears, 1. left above, 2. bottom right and 3. in the middle, a calibration cross that must be pushed consecutively.

If the calibration finished and the touch-screen display averaged, you can confirm with **OK**.

Is this not the case, so you can repeat the calibration with the help of the **Cancel** and **Calibrate** buttons.

9.14.3 Cleaning

Main menu → Settings → Cleaning



This function can be used for cleaning the touch panel during running measurements.

If one minute is not enough time to clean, the process can be repeated at any time.

Is the cleaning faster finished, then you can push the **to abort press long** button (for one or two seconds) to cancel.

9.14.4 System Status

Main menu → Settings → System Status

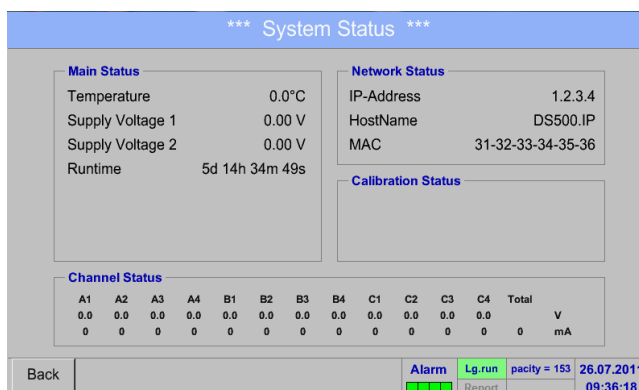

The function **System Status** offers an overview, fitting voltages and currents on the individual and the entire channels, as well as the power supply of the power supply units.

In addition, it offers the most important network information, such as **IP**, **host name** and **MAC**.

By the **Runtime**, you always know how long the DS 500 was in total in operation.

9.14.5 About DS 500

Main menu → Settings → About DS 500

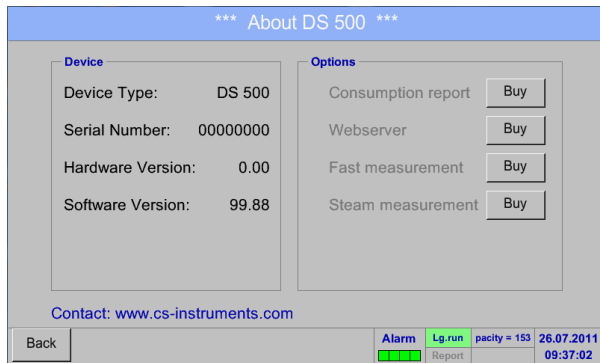

*** About DS 500 ***

Device	Options
Device Type: DS 500	Consumption report <input type="button" value="Buy"/>
Serial Number: 00000000	Webservice <input type="button" value="Buy"/>
Hardware Version: 0.00	Fast measurement <input type="button" value="Buy"/>
Software Version: 99.88	Steam measurement <input type="button" value="Buy"/>

Contact: www.cs-instruments.com

Back Alarm Lq.run pacity = 153 26.07.2011 09:37:02

Brief description of the **Hardware** and **Software Version**, as well as the **Serial Number** of the DS 500.

Under options, you can buy four additional, different functions, if you haven't done this by ordering.

9.15 Consumption report with cost settings, export data and webserver

The daily, weekly, monthly and yearly total consumption can be calculated and displayed with the optional function *Consumption report*.

The currency will be entered in the *report settings* (chapter 9.15.1 *Report settings (optional)*) and the consumption costs in chapter 9.15.2 *Cost settings (optional)*.

Via the optional function *Webserver* you can see the actual values of your DS 500 worldwide.

9.15.1 Consumption report (optional)

Main menu → Consumption report

*** Consumption report ***

Week	<A1> Hall 1.1 compressed air					Total
	Consumption per day m ³	Costs €	max value m ³ /h	min value m ³ /h	average m ³ /h	
2011Week 17						
2011Week 18						
2011Week 19						
2011Week 20	59	11.54	0.000	12.500	0.000	46.40
2011Week 21	111	20.88	0.200	11.500	0.000	76.04
2011Week 22	27	5.40	0.200	11.500	0.000	22.20
2011Week 23						
2011Week 24						
2011Week 25						
2011Week 26						

Home Day/Week Week Month/Year

After opening the *Consumption report* the weekly overview is displayed automatically.

Remark:

The *Costs* relate to the set channel (here A1) and the costs of all documented channels are to find in *Total*.

Main menu → Consumption report → Day/Week

*** Consumption report ***

Day/Week	<A1> Hall 1.1 compressed air					Total
	Consumption per day m ³	Costs €	max value m ³ /h	min value m ³ /h	average m ³ /h	
24.05.2011 Tue	5	0.92	0.200	11.500	0.208	5.28
25.05.2011 Wed	5	0.92	0.200	11.500	0.208	5.28
26.05.2011 Thu	15	2.76	0.200	11.500	0.625	9.32
27.05.2011 Fri	20	3.56	0.200	11.500	0.833	10.32
28.05.2011 Sat	20	3.86	0.200	11.500	0.833	12.12
29.05.2011 Sun	15	2.76	0.200	11.500	0.625	9.32
Total Week 21	111	20.88	0.200	11.500	0.000	76.04
30.05.2011 Mon	5	0.92	0.200	11.500	0.208	4.76
31.05.2011 Tue	11	2.24	0.200	11.500	0.458	8.28
01.06.2011 Wed	11	2.24	0.200	11.500	0.458	9.16

Home Day/Week Week Month/Year

Another option is the daily and weekly *Consumption report*.

Main menu → Consumption report → Month/Year

*** Consumption report ***

Month/Year	<A1> Hall 1.1 compressed air					Total
	Consumption per day m ³	Costs €	max value m ³ /h	min value m ³ /h	average m ³ /h	
2010 May	7257	109.34	3.7	35.8	15.8	308.89
2010 June	9530	143.11	3.8	36.1	18.9	402.65
2010 July	7325	110.56	3.9	37.2	14.5	327.48
2010 August	8099	121.83	3.9	37.1	16.1	353.21
2010 September	7842	118.51	3.9	36.8	15.6	367.43
2010 October	6167	93.77	3.9	37.3	12.2	291.19
2010 November	9030	135.07	3.9	37.5	17.9	311.86
2010 December	9062	136.23	3.9	37.5	18.0	388.97
2010 Total	97953	1472.42	3.8	37.1	16.3	4168.68
2011 January	8880	133.31	3.5	37.7	17.6	412.17

Home Day/Week Week Month/Year

In addition, there is a monthly and yearly *Consumption report*.

Touch panel operation by Consumption report:

By the *Consumption report*, with the help of touch panel, you can easily consider the consumption and the cost of a channel in the desired period or at a certain date.

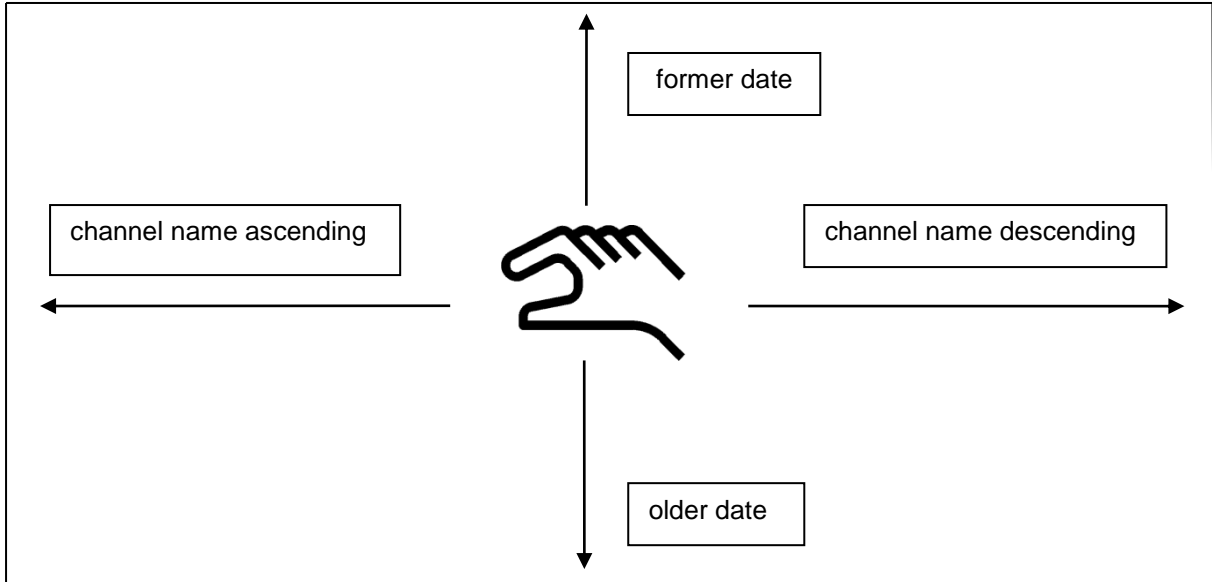

Remark: The channel selection in *Consumption report* is marked in green!

9.15.2 Cost settings (optional)

Main menu → Settings → Sensor settings → A1 → Cost Settings



In the *Sensor settings* for the *Type CS-Digital* and *Pulse* you can enter the costs per unit in the *Cost Settings*.

Main menu → Settings → Sensor settings → A1 → Cost Settings → *use in Report* button

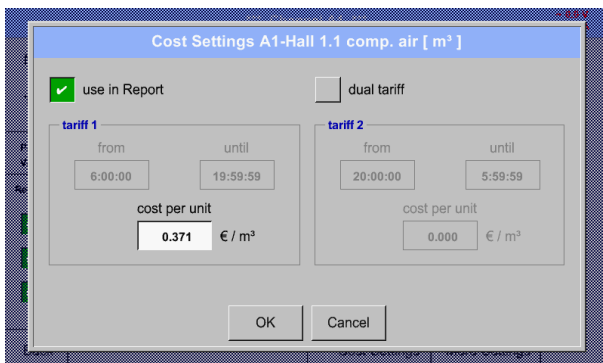

Here you can enter the consumption costs per unit for a specific tariff.

Main menu → Settings → Sensor settings → A1 → Cost Settings → *use in Report* + *dual tariff* button

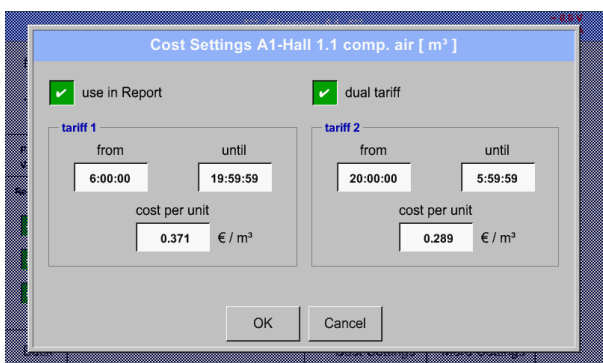

It can be entered here, for example, a day and night tariff with time.

Label of the description fields, see chapter [9.3.2.2 Label and setting the description fields](#) and [9.4 Logger settings](#).

9.16 Webserver (optional)

With the web server you have access, worldwide, to the DS 400 system information, the measurement data, the possibility to start the logger and also to install an e-mail notification in case of measurement exceedances (alarms).

The individual functions are accessible via different user levels, every level is protected. The allocation of access rights is done by the system administrator. Overview access permissions see chapter [9.16.3.11 Webserver assignment of rights](#).

9.16.1 Option „Webserver“ activation

After purchasing of the option „Webserver“ the functionality have to be activated first

Main menu → Settings → about DS 500

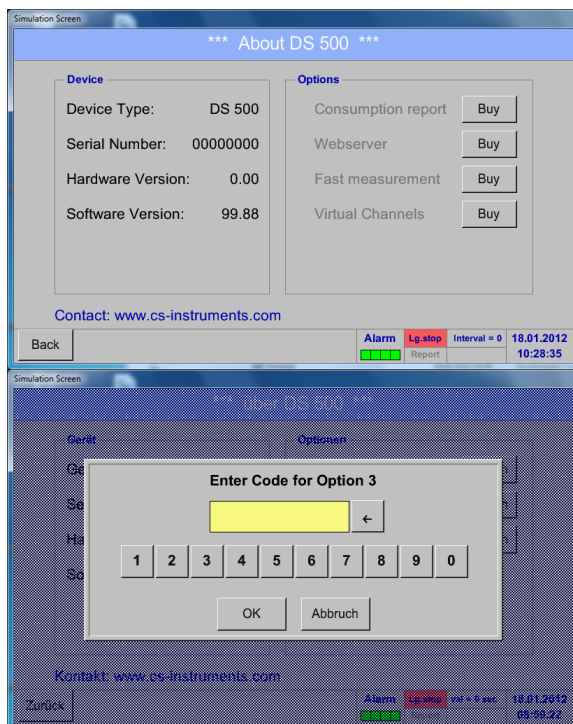

Please push the button *Buy* for „Webserver“ and you will requested to insert the key-code received

Please enter the Key-Code in the text-field and activate the option by pushing the button *OK*.

9.16.2 Setup the Webserver Admin Password

The setup of the Web Admin password is done under
Home → Settings → Device Settings → Network Settings

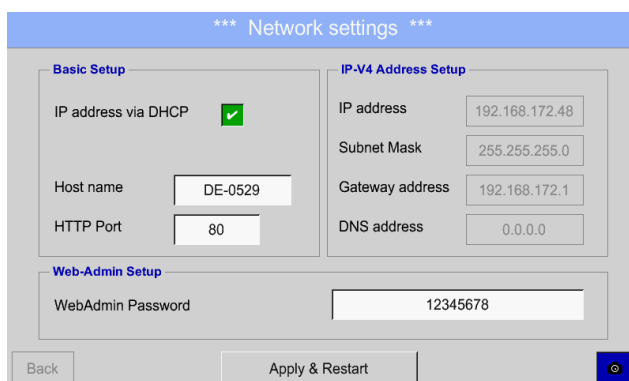

In the text description field *WebAdmin Password* could the password be set up. The password length is ≥ 8 characters.

9.16.3 Webserver start

With an Internet-Explorer (IE, Firefox, Chrome) and the IP-address of your DS 500, you can access the webserver.

http:// <IP-Adresse des DS500>

Remark:

The IP-address of the DS 500 you can see in the chapters [9.14.4 System Status](#) and [9.5.3 Network settings](#).

Webserver Start window Info:

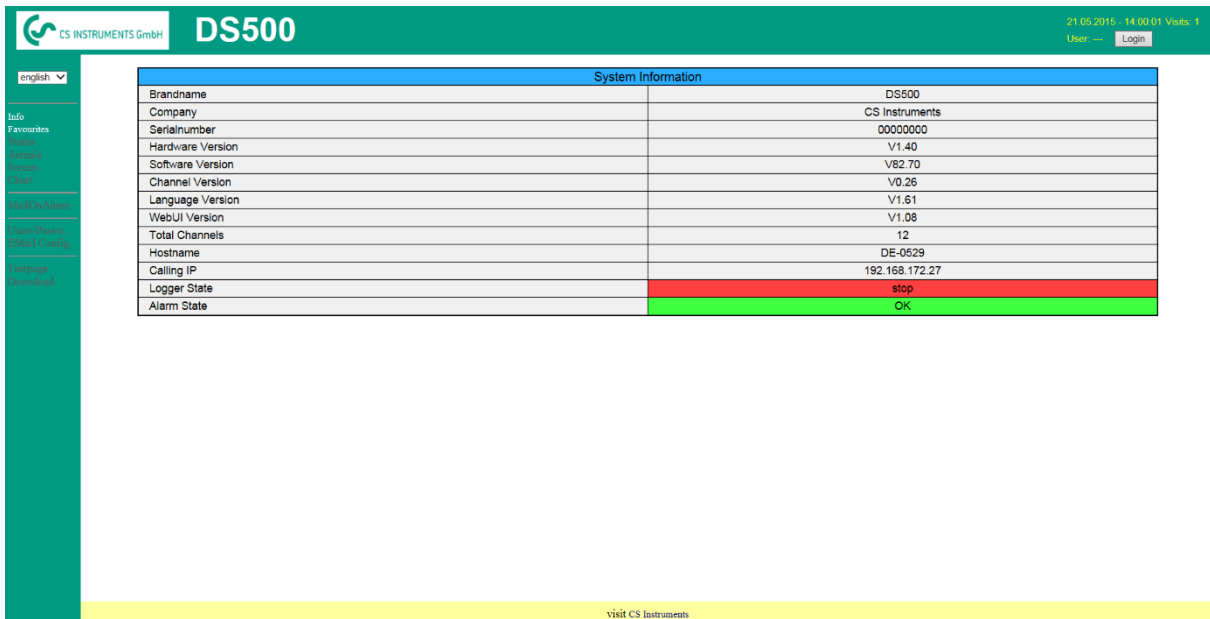

The screenshot shows the webserver interface for a DS500 device. The header includes the CS INSTRUMENTS GmbH logo, the device name 'DS500', and a status bar with the date '21.05.2015', time '14:00:01', and 'Visits: 1'. A 'Login' button is visible in the top right. On the left, there is a navigation menu with options like 'Home', 'Favourites', 'About', 'Status', 'Help', 'Settings', 'Language', 'Logout', and 'Shutdown'. The main content area displays a 'System Information' table with the following data:

System Information	
Brandname	DS500
Company	CS Instruments
Serialnumber	00000000
Hardware Version	V1.40
Software Version	V82.70
Channel Version	V0.26
Language Version	V1.61
WebUI Version	V1.08
Total Channels	12
Hostname	DE-0529
Calling IP	192.168.172.27
Logger State	stop
Alarm State	OK

At the bottom of the page, there is a yellow bar with the text 'visit CS Instruments'.

No access rights are required, see [chapter 9.16.3.1.1](#)

9.16.3.1 Webserver assignment of rights (Administrator)

9.16.3.1.1 Access rights Webserver

For individual functions, appropriate privileges are required, see table "access rights"

Rights Group	Info	Status	Actuals	Chart	MailonAlarm	Settings User/Mail
w/o	X					
Guest	X	X	X			
User	X	X	X	X		
Operator	X	X	X	X	X	
Admin	X	X	X	X	X	X

Table Access rights

9.16.3.1.2 Webserver Login

After pressing the Button « Login » following screen is visible.

Logion as Administrator with Username « admin » and the WebAdmin Password.

Setup of the WebAdmin Passwords see [chapter 9.16.2.](#)

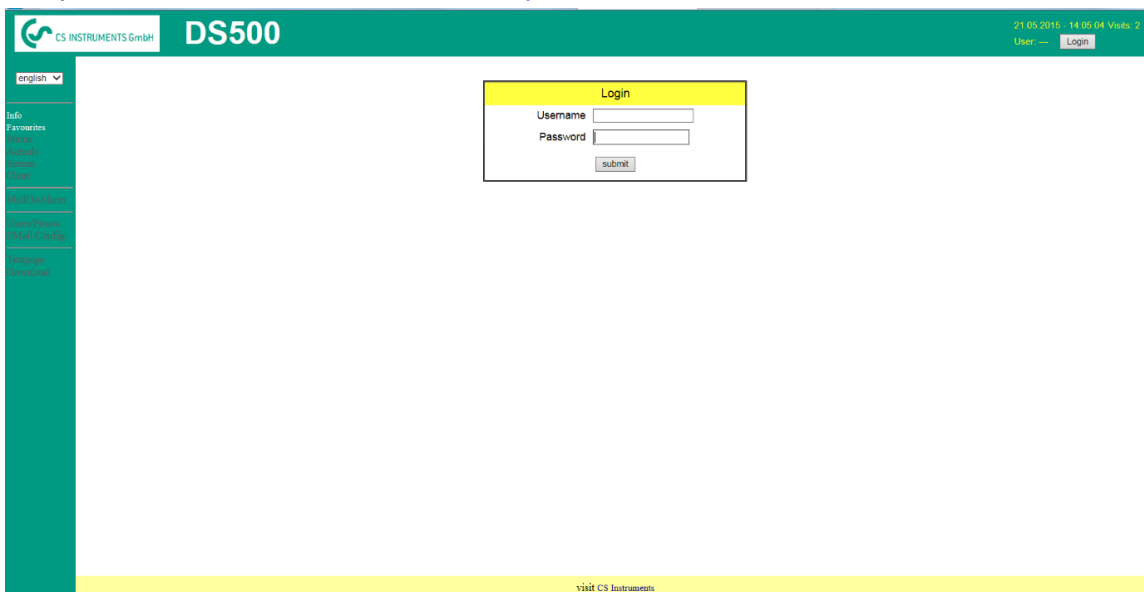

After starting as Administrator all the functions on the left side are activated.

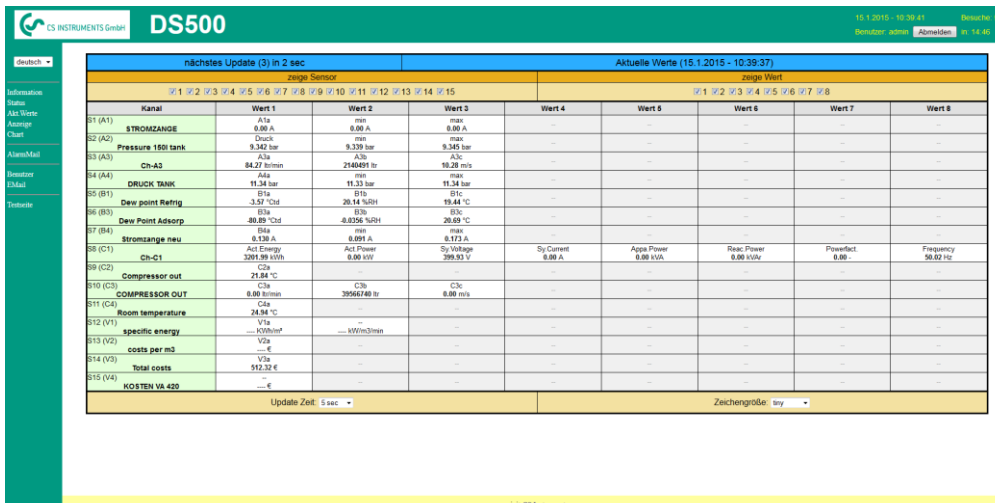

nächstes Update (3) in 2 sec				Aktuelle Werte (15.1.2015 - 10:39:37)				
zeige Sensor				zeige Wert				
Kanal	Wert 1	Wert 2	Wert 3	Wert 4	Wert 5	Wert 6	Wert 7	Wert 8
S1 (A1) STROMZANGE	0.00 A	0.00 A	0.00 A					
S2 (A2) Pressure 150l tank	9.242 bar	9.239 bar	9.245 bar					
S3 (A3) CH-A3	84.27 bit/min	214491 tr	19.28 m/s					
S4 (A4) DRUCK TANK	11.34 bar	11.33 bar	11.34 bar					
S5 (B1) Dew point Refrig	-3.57 °C/d	26.14 %RH	19.44 °C					
S6 (B5) Dew Point Adsorp	-8.89 °C/d	8.8356 %RH	26.69 °C					
S7 (B4) Stromzange neu	0.138 A	0.691 A	0.112 A	Sy Current 6.88 A	Appa Power 0.88 kVA	Reac Power 0.88 kVar	Powerfact 0.88	Frequency 50.02 Hz
S8 (C1) CH-C1	Act Energy 2081.89 kWh	Act Power 6.89 kW	Sy Voltage 399.93 V					
S9 (C2) Compressor out	C2a 21.84 °C	C2b 0.89 bit/min	C2c 39562.48 tr	C3c 6.89 m/s				
S10 (C3) COMPRESSOR OUT	C3a 24.94 °C							
S11 (C4) Room temperature	V1a --- kWh/m²	--- kWh/m³min						
S12 (V1) specific energy	V2a --- €							
S13 (V2) costs per m3	V3a 912.31 €							
S14 (V3) total costs								
S15 (V4) KOSTEN VA 420								

9.16.3.1.3 New users and password definition

Selection of function « **Users/Passw.** » (only for Administrator accessible)

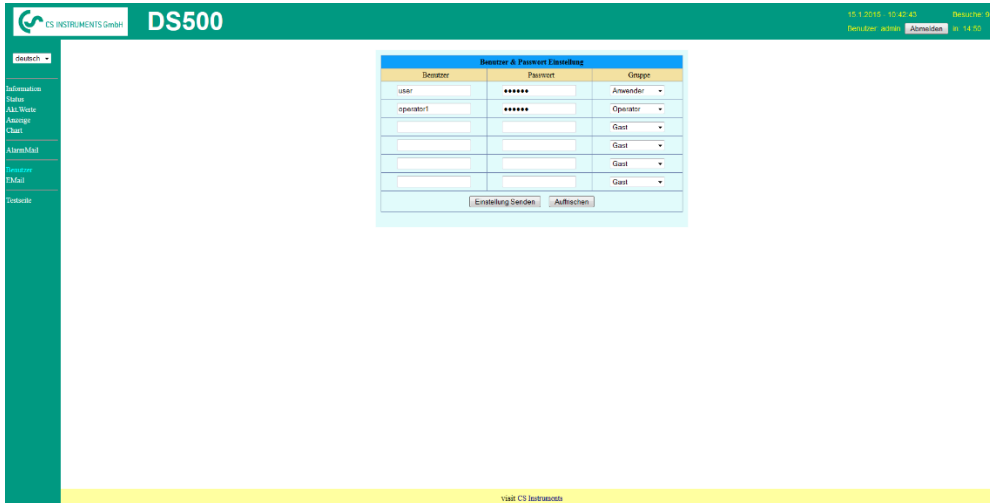

Benutzer	Passwort	Gruppe
user	*****	Anwender
operator	*****	Operator
		Gast
		Gast
		Gast
		Gast

Erstellung Sendet Auffrischen

With this function you are able to define the users with their corresponding access rights.

Username : min. 4 characters; max. 12 characters

Password : min. 4 characters, max. 12 characters

Group : see access rights chapter 9.16.3.1.1

The inputs will be stored with « **Submit** »

9.16.3.2 Webserver E-Mail Configuration (Administrator)

Access of function « **E-Mail** » only for administrators

In case you are not logged in as administrator, please see Chapter 9.16.1.4.1

Auswahl von Menüpunkt « **E-Mail** » (nur für Administratoren zugänglich)

At the first/ initial configuration there are no entries.

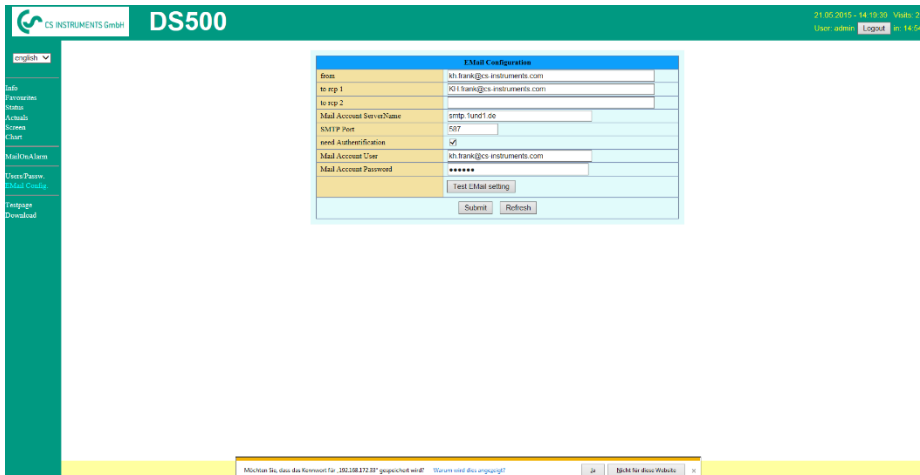

An existing mail account and those access data are needed for final mail configuration.

E-Mail Configuration	
from	kh.frank@cs-instruments.com
to rcp 1	KH.frank@cs-instruments.com
to rcp 2	
Mail Account ServerName	smtp.1und1.de
SMTP Port	587
need Authentication	<input checked="" type="checkbox"/>
Mail Account User	kh.frank@cs-instruments.com
Mail Account Password	*****
<input type="button" value="Test EMail setting"/>	
<input type="button" value="Submit"/> <input type="button" value="Refresh"/>	

from: mail username
to rcp 1: mail Address recipient 1
to rcp 2: mail Address recipient 2
Mail-Account Server name: Name of SMTP Mail output server of your provider
Mail Account User: mail Address of user
Mail Account Password: user password of mail account

It is possible to define max. 2 mail recipients.

The settings will be stored by pressing « **Submit** »

A verification (correctness of your settings) could be done by sending a test mail.

Therefore please press the button « **Test EMail setting** »

```
E-Mail Test ... OK
see below
```

```
MailServer IP = 212.227.15.167
try to Connected
Connected
try auth login
login OK
send header
send body
send quit
tcp_close OK
SMTP-Task ready
```

Are all settings ok, a message, see left, will be displayed and a mail should be received by the defined recipients.

9.16.3.3 Webserver MailOnAlarm (Administrator & Operator)

This feature allows sending an e mail at limit violations (alarms) to the addresses defined under EMail. Mail delivery's are based on the respective Alarm relay, ie when limits are exceeded and the relays are activated an E-mail will be sent too.

The EMail content is fixed only one short comment could be added.

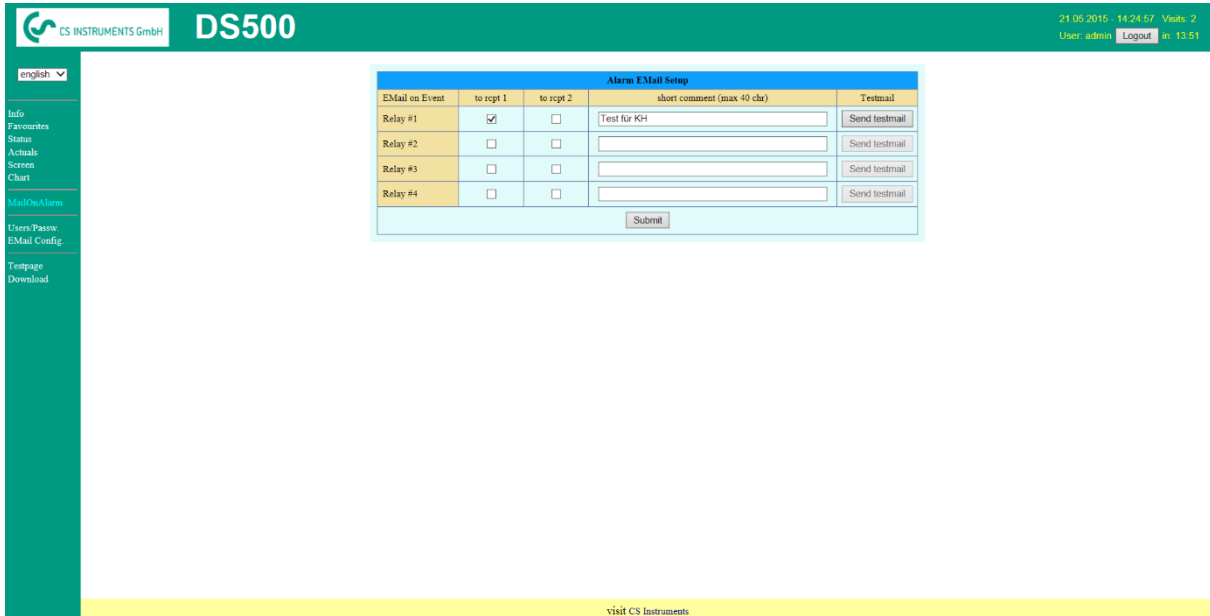

The screenshot shows the DS500 webserver interface. At the top, there is a green header with the CS INSTRUMENTS GmbH logo and the text 'DS500'. On the right side of the header, it displays the date and time '21.05.2015 - 14:24:57' and the user 'User: admin' with a 'Logout' button. A language dropdown menu is set to 'english'. On the left side, there is a vertical navigation menu with options: Info, Favourites, Status, Actuals, Screen, Chart, MailOnAlarm (highlighted), Users/Passw., EMail Config., Testpage, and Download. The main content area displays the 'Alarm EMail Setup' form, which is a table with columns: 'EMail on Event', 'to rcpt 1', 'to rcpt 2', 'short comment (max 40 chr)', and 'Testmail'. There are four rows for Relay #1 through Relay #4. Relay #1 has 'to rcpt 1' checked and a comment 'Test für KH'. Each row has a 'Send testmail' button. A 'Submit' button is at the bottom of the form. At the bottom of the page, there is a yellow bar with the text 'visit CS Instruments'.

Alarm EMail Setup				
EMail on Event	to rcpt 1	to rcpt 2	short comment (max 40 chr)	Testmail
Relay #1	<input checked="" type="checkbox"/>	<input type="checkbox"/>	Test für KH	Send testmail
Relay #2	<input type="checkbox"/>	<input type="checkbox"/>		Send testmail
Relay #3	<input type="checkbox"/>	<input type="checkbox"/>		Send testmail
Relay #4	<input type="checkbox"/>	<input type="checkbox"/>		Send testmail
Submit				

In this form the recipients for the required alarms could be set/defined.

In addition a short comment could be added.

With the button *Submit* the settings are stored.

Alarm Email Content:

DS 500 ALARM

Event: 15.01.2015 13:49:20

IP: 192.168.172.39

Hostname: DE-0529

- Alarm for Relais_1 Level_1 Comment: Test1
 - Channel (A2) "Ch-A2" Value "Temp."
 - Actual = 30.33°C > 30.000°C (Limit ± Hyst.)

End of message

9.16.3.4 Webserver Chart (Administrator, Operator & Anwender)

With these function it is possible to access and view all measurement data stored on the DS500 SD card. The data are by a continuous recording, on a daily base, else according the used recording period stored.

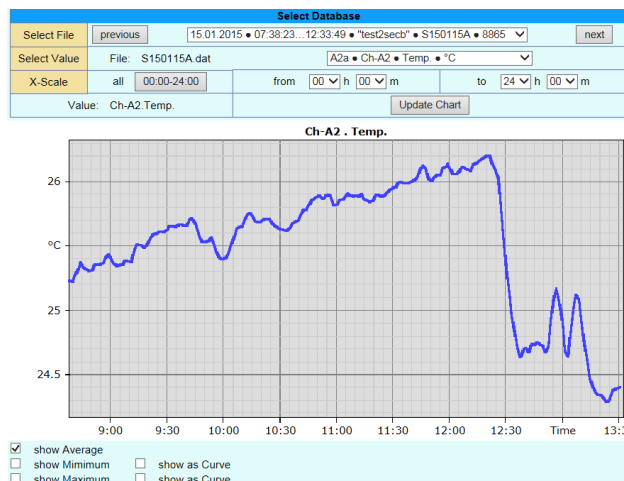
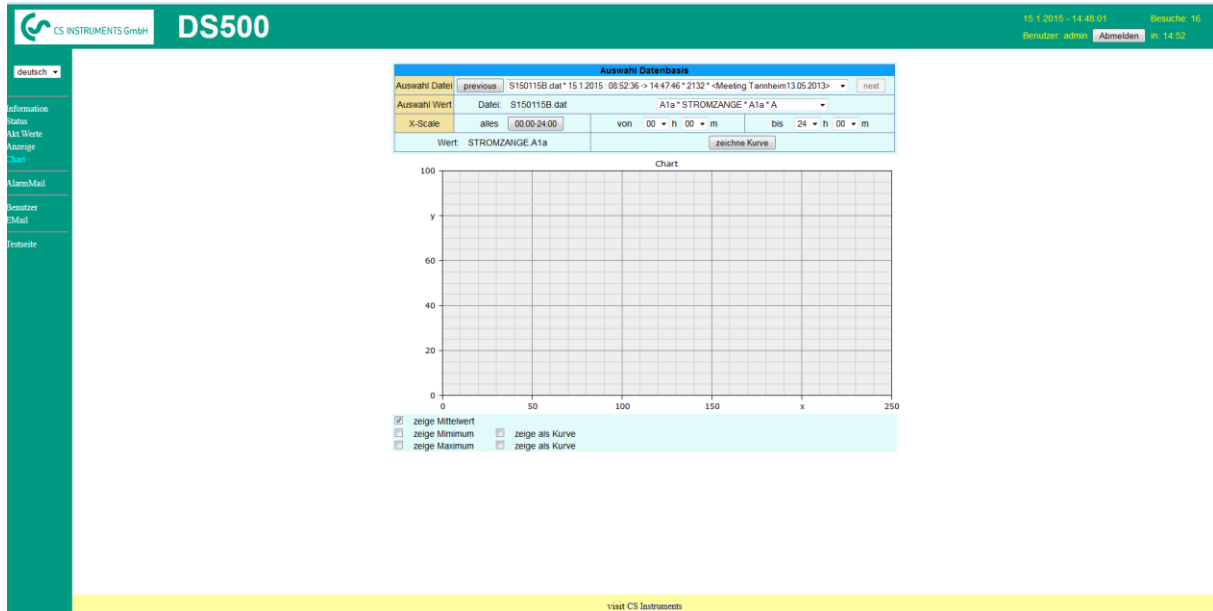

Select File : In this drop down field a measurement data file could be selected. With buttons *previous* & *next* could be switched between the files

Select Value : Here the required measurement value has to selectd

X-Scale : With entering a time in the field «*from*» and «*to*», a specific timespan could be defined.

VI Ewing of data by pressing button *Update Chart*, in addition *show average* must be enabled.

With *show Minimum* and *show Maximum* the min and max values will be displayed too.

With activation of *show as curve* the min and max values will be display as curve.

9.16.3.5 Webserver Screen

Herewith it is possible to get a screen copy of the DS500 for Home menu, Chart/RT, Channels, Realtime values, Alarm and Settings (System status, about DS 500).

Remark :

Any selection change done through the webserver is transferred to the DS 500 too.

With simultaneous access to the DS 500 by webserver and an operator direct at the DS500 the operator has priority. By simultaneous web access, priority is according to access rights.

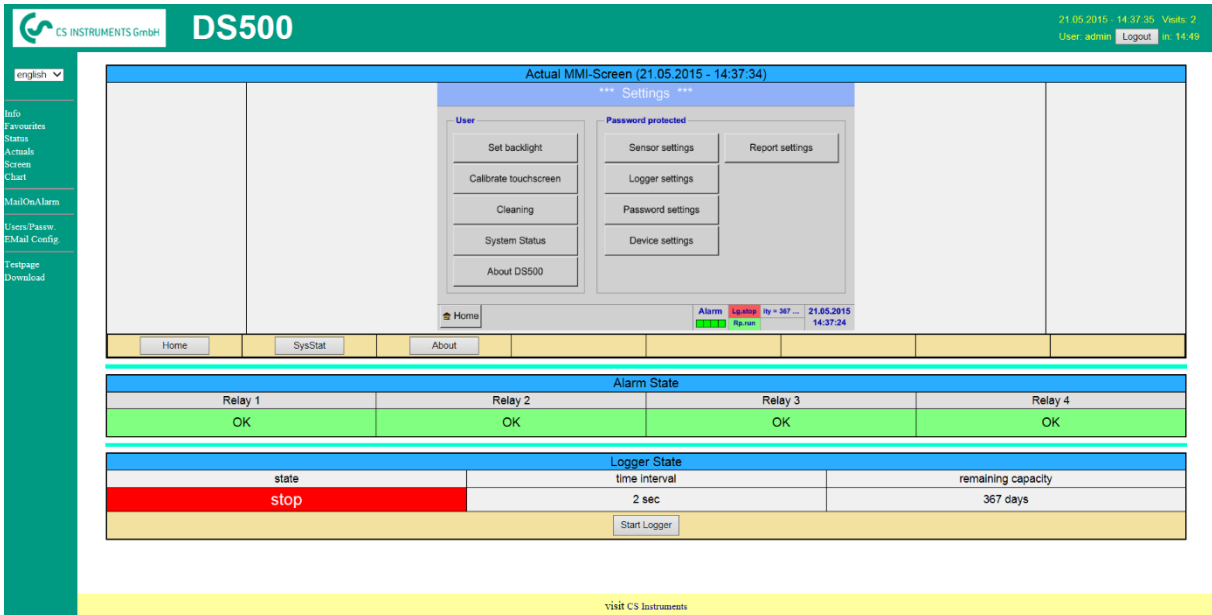

Anzeige → Chart/RT



Timescale: The required timespan could be selected
 Active Plot : Herewith could one of the defined curves selected where for which the Y-scale will be displayed . A double click will switch on / switch off the corresponding curve
 Both function are analog DS500. By pressing *Home* the screen is going back to the main menu.

Anzeige → Channels

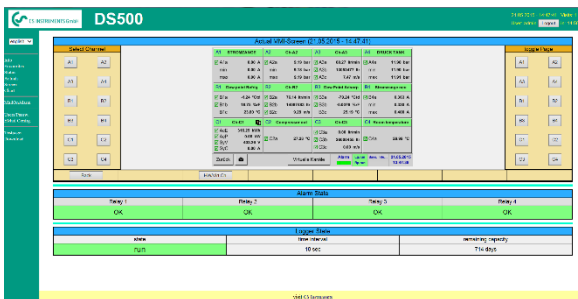

Select channels : Selection of single channel
 Page: If the sensor has more as 4 values , by pressing this button you can switch to 2.page.
 HW/VirtCh. : Switch to *Virtual Channel*
 Settings are analog to DS 400
 By pressing *Back* the screen is going back to the main menu

Analog dazu werden die Ansichten

- Realtime values
 - Alarm
 - Report
 - Settings
- Screen → Realtime
 - Screen → Alarm
 - Anzeige → Report
 - Screen → Settings

is done analog to above.

9.16.3.6 Webserver Actuals

CS INSTRUMENTS GmbH
DS500
21.05.2016 - 14:53:23 View: 1
User: admin Logout in 14:58

english
 Info
 Favourites
 Status
 Actuals
 Screen
 Chart
 MailOnAlarm
 Users/Passw
 EMail Config
 Testpage
 Download

next Update (1) in 59 sec				Actual Values (21.05.2016 - 14:53:21)				
show Sensors				show Values				
<input checked="" type="checkbox"/> 1 <input checked="" type="checkbox"/> 2 <input checked="" type="checkbox"/> 3 <input checked="" type="checkbox"/> 4 <input checked="" type="checkbox"/> 5 <input checked="" type="checkbox"/> 6 <input checked="" type="checkbox"/> 7 <input checked="" type="checkbox"/> 8 <input checked="" type="checkbox"/> 9 <input checked="" type="checkbox"/> 10 <input checked="" type="checkbox"/> 11 <input checked="" type="checkbox"/> 12 <input checked="" type="checkbox"/> 13 <input checked="" type="checkbox"/> 14 <input checked="" type="checkbox"/> 15 <input checked="" type="checkbox"/> 16				<input checked="" type="checkbox"/> 1 <input checked="" type="checkbox"/> 2 <input checked="" type="checkbox"/> 3 <input checked="" type="checkbox"/> 4 <input checked="" type="checkbox"/> 5 <input checked="" type="checkbox"/> 6 <input checked="" type="checkbox"/> 7 <input checked="" type="checkbox"/> 8				
Channel	Value 1	Value 2	Value 3	Value 4	Value 5	Value 6	Value 7	Value 8
S1 (A1) STROMZANGE	A1a 13.48 A	min 12.78 A	max 14.10 A	—	—	—	—	—
S2 (A2) Ch-A2	A2a 9.18 bar	min 9.17 bar	max 9.19 bar	—	—	—	—	—
S3 (A3) Ch-A3	A3a 60.18 ltr/min	A3b 13054012 ltr	A3c 7.42 m/s	—	—	—	—	—
S4 (A4) DRUCK TANK	A4a 12.10 bar	min 12.10 bar	max 12.11 bar	—	—	—	—	—
S5 (B1) Dew point Refrig	B1a -1.16 °C/d	B1b 18.95 %rF	B1c 23.74 °C	—	—	—	—	—
S6 (B2) Ch-B2	B2a 96.34 ltr/min	B2b 14088100 ltr	B2c 11.75 m/s	—	—	—	—	—
S7 (B3) Dew Point Adsorp	B3a -79.25 °C/d	B3b -0.0025 %rF	B3c 25.17 °C	—	—	—	—	—
S8 (B4) Stromzange neu	B4a 14.492 A	B4b 14.083 A	B4c 14.352 A	Sy Current 14.32 A	Appa Power 9.92 kVA	Reac Power 3.98 kVAr	Powerfact 0.83	Frequency 50.01 Hz
S9 (C1) Ch-C1	C1a 316.42 kWh	C1b 8.26 kW	C1c 400.10 V	—	—	—	—	—
S10 (C2) Compressor out	C2a 23.85 °C	—	—	—	—	—	—	—
S11 (C3) Ch-C3	C3a 1101.86 ltr/min	C3b 28001361 ltr	C3c 20.45 m/s	—	—	—	—	—
S12 (C4) Room temperature	C4a 31.29 °C	—	—	—	—	—	—	—
S13 (V1) specific energy	V1a 0.28717 kWh/m³	V1b 0.01 kWh/m³/min	—	—	—	—	—	—
S14 (V2) costs per m3	V2a 0.0459 €	—	—	—	—	—	—	—
S15 (V3) Total costs	V3a 59.53 €	—	—	—	—	—	—	—
S16 (V4) KOSTEN VA 420	V4a 599781 €	—	—	—	—	—	—	—

Refresh Time: 60 sec
Font size: tiny

- show Sensor: enable / disable the view for individual sensors
- show values: enable / disable the view for individual sensor values
- Refresh time: Selection of the timespan of the data update (60s, 30s, 10s, 5s, 2s,1s)
- Font size: Size of characters (4 different sizes)

9.16.3.7 Webserver Status

CS INSTRUMENTS GmbH
DS500
16.01.2016 - 13:17:03 besuche: 6
Benutzer: operator1 Abmelden in 14:49

Deutsch
 Information
 Home
 Akt. Werte
 Messung
 Chart
 AlarmMail
 User
 Testseite

Alarm Status			
Relais 1	Relais 2	Relais 3	Relais 4
OK	OK	OK	OK

Logger Status		
Status	Zeitintervall	Restkapazität
Stopp	10 Sekunden	930 Tage

Möchten Sie, dass das Kennwort für „182.168.872.371“ gespeichert wird? Warum wird dies eingepflegt?

Here you have an overview of Relays and Logger status.

Remark:

In case the logger is stopped, only user with access rights of administrator or operator are able to start the logger. To stop the logger it is only possible at the DS 500 direct.

9.17 Import / Export

9.17.1 Export Logger data

Recorded data can be transferred to a USB stick, by using *Export Data*.

Main menu → Import / Export

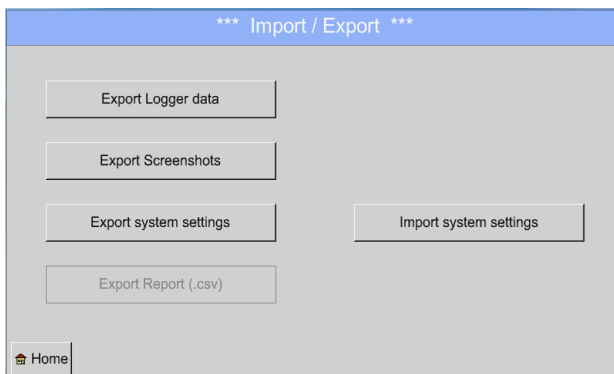

With *Export Logger data*, *Export Screenshots*, *Export system settings* and *Export Report* the recorded measurement data and saved screenshots and settings can be transferred to a USB stick.

Also with *Import system settings* saved system settings could be imported.

Main menu → Import / Export → Export Logger data

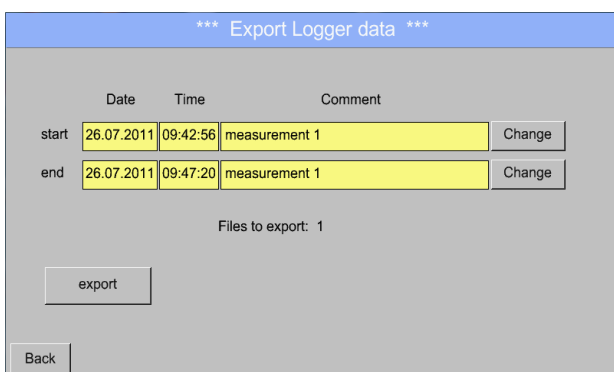

Use the *Change* buttons to adjust a period between *start* and *end*. Stored measurement data in this period are exported.

Main menu → Import / Export → Export Logger data → Change



The selected date is always green, and the date numbers of the Sundays are red, like in the calendar.

On days, where measurement data were recorded, the date numbers are optical highlighted.

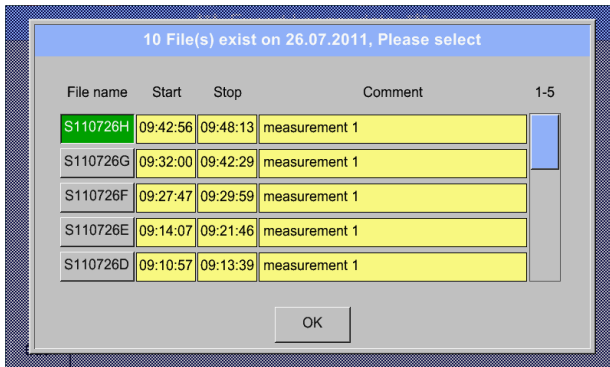

If there have been recorded several measurements on the same date, they appear after the date selection with **OK**.

Now a recording can be selected comfortable.

Main menu → Import / Export → Export Logger data → export

The measurement data of the selected period are exported to a USB stick.

9.17.2 Screenshots export

The screenshots stored on the SD card can be exported to a USB stick

Main menu → Import / Export

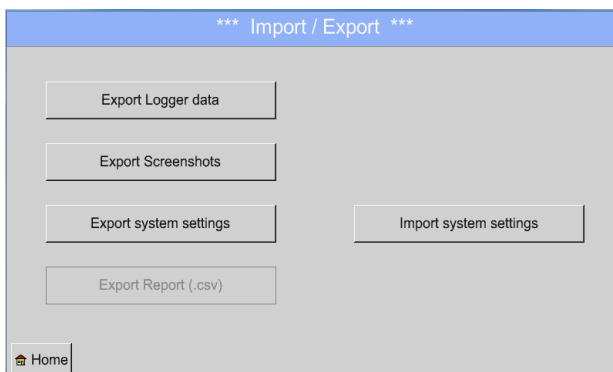

With **Export Screenshots** the recorded screenshots data can be transferred to a USB stick.

Main menu → Import / Export → Export Screenshots

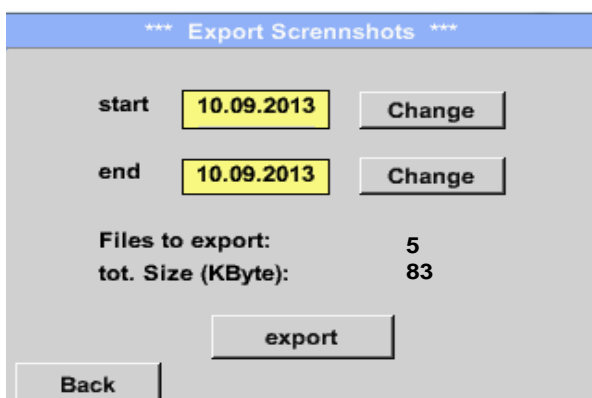

Use the **Change** buttons to adjust a period between **start** and **end**. Stored bitmaps data in this period are exported.

Main menu → Import / Export → Export Screenshots → Change



The selected date is always green, and the date numbers of the Sundays are red, like in the calendar.

On days, where measurement data were recorded, the date numbers are optical highlighted.

Main menu → Import / Export → Export Screenshots → Export

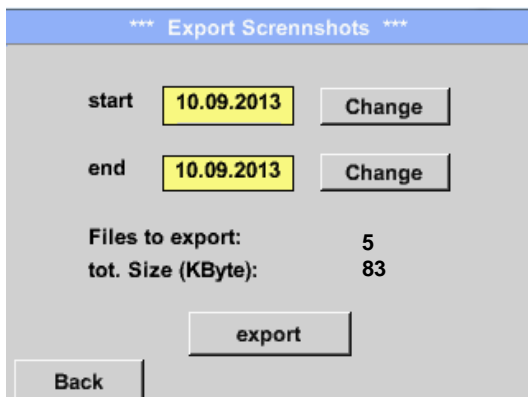

The screenshots of the selected period are exported to a USB stick.

9.17.3 Export System Settings

Main menu → Import / Export → Export system settings

By using *Export system settings*, all existing sensor settings can be exported to a USB stick. All sensor settings including recording-, alarm- measurement values resolution, graphic-, real time values – and name definition settings are stored.

9.17.4 Export Report

Main → Import / Export → Export Report

By using *Export Report*, all existing **reports** can be exported in CSV-format to a USB stick.

9.17.5 Import system settings

Using this function, stored system settings can be read back again.

All sensor settings including recording-, alarm-, measurement resolution-, graphics-, current values- and naming-definitions are taken over.

Main menu → Import / Export → Import system settings

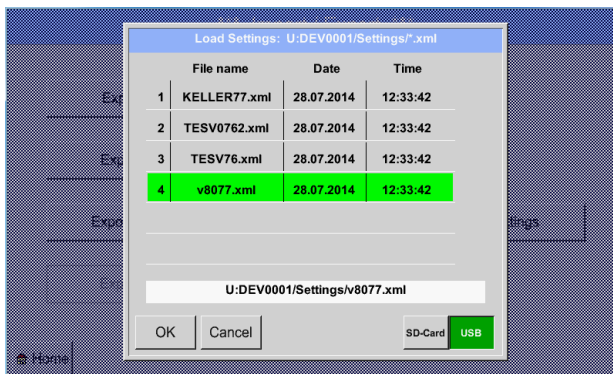

Please select the needed storage location
SD-Card or *USB* stick.

Select the needed file and confirm by pressing
OK.



After confirmation with OK it is asked again if settings should be overwritten, by confirming this once more the new System Settings are loaded and a reboot is required.

To definitively take over the new settings it is **mandatory** under

Main menu → Device settings → → Sensor settings

to confirm each used channel A1-C4 again.

10 Screenshot function

This function allows you to store a copy of the screen of the menus Chart, Chart / Real time Values, Channels and Real time Values to a USB-Stick or SD-Card. Mainly foreseen to save not logged data.

10.1 Screenshot saving

Main menu → Chart →

Main menu → Chart / real time Values →

Main menu → Channels →

Main menu → Real time Values →

Main menu → Settings → Sensor Settings →

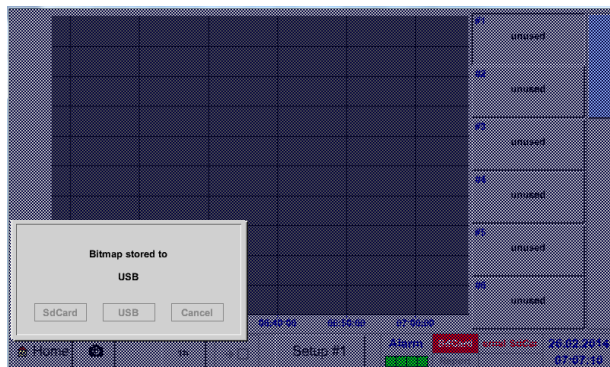
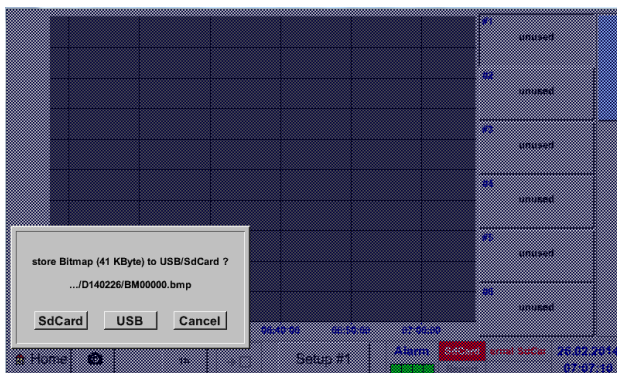

Here, the location of USB stick or SD card can be selected.

Screenshots are stored in directories defined per day and here numbered consecutively.

Directory naming; DYYMMTT
D=fix(für Date)
YY = Year
MM= Month
TT= Day

Path: DEV0001/Hostname/Bitmap

For Hostname see
[Main menu → Settings → System Status](#)

Example: first Screenshot 26. Februar 2014

\\DEV0001/DE-5001/Bitmap/D140226/B00000.bmp

11 Cleaning

**Note:**

The DS 500 has a cleaning-function which protects the display against unintentional operation in the event of cleaning measures. Please refer to [Chapter 12.14.3](#) for further information.

Cleaning of the DS 500 must be undertaken using a slightly damp (not wet) cotton cloth or one-way wipe, and mild, commercially available cleaner/soap.

For decontamination, spray the cleaner on an unused cotton cloth or one-way wipe, and wipe the component comprehensively. Perform the final drying with a clean cloth or by air drying.

In addition, the local hygiene provisions need to be observed.

**Warning!****Damage possible!**

A too high degree of humidity and hard and pointed objects, as well as aggressive cleaners, cause damage to the data logger and to the integrated electronic components.

Measures

- Never clean with a soaked cloth.
- Do not use aggressive cleaners.
- Do not use pointed or hard objects for cleaning.

KONFORMITÄTSERKLÄRUNG

DECLARATION OF CONFORMITY

Wir
We

CS Instruments GmbH
Am Ocker 28c, 24955 Harrislee

Erklären in alleiniger Verantwortung, dass das Produkt
Declare under our sole responsibility that the product

Multi-Messgerät DS 500
Multifunction measuring instrument DS 500

den Anforderungen folgender Richtlinien entsprechen:

We hereby declare that above mentioned components comply with requirements of the following EU directives:

Elektromagnetische Verträglichkeit Electromagnetic compatibility	2014/30/EU 2014/30/EC
Niederspannungsrichtlinie Low Voltage Directive	2014/35/EU 2014/35/EC

Angewandte harmonisierte Normen:

Harmonised standards applied:

EMV-Anforderungen EMC requirements	EN 61326-1: 2006-10 2013-07 EN 61000-3-2: 2015-3
Sicherheitsanforderungen Safety requirements	EN 61010-1:2010

Anbringungsjahr der CE Kennzeichnung: 11

Year of first marking with CE Label: 11

Das Produkt ist mit dem abgebildeten Zeichen gekennzeichnet.
The product is labeled with the indicated mark.

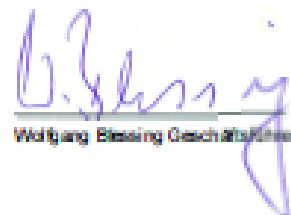

Harrislee, den 19.04.2016

Wolfgang Blessing Geschäftsführer