



Instruction manual

Flow Sensor

VA 570



I. Foreword

Dear customer,

thank you very much for deciding in favour of the VA 570. Please read this installation and operation manual carefully before mounting and initiating the device and follow our advice. A riskless operation and a correct functioning of the VA 570 are only guaranteed in case of careful observation of the described instructions and notes

II. Table of Content

I.	Foreword	2
II.	Table of Content	3
1	Pictograms and Symbols	5
2	Signalwords according ISO 3864 and ANSI Z 535	5
3	Safety instructions.....	6
3.1	Intended Use.....	7
3.2	Installation and commissioning	7
4	Technical data.....	8
4.1	Signal circuits.....	9
4.1.1	Modbus	9
4.1.2	Current output	9
4.1.2.1	Aktive	9
4.1.2.2	Passive	9
4.1.3	Pulse	9
4.1.4	Alarm.....	9
4.2	Measuring range flow VA 570	10
5	Dimensions	11
5.1	Dimension VA 570 Thread-version.....	11
5.2	Dimension VA 570 Flanged-version	Fehler! Textmarke nicht definiert.
6	Installation.....	13
6.1	Pipe/tube requirements	13
6.2	Inlet / outlet runs	13
6.2.1	Installation of VA 570	14
6.3	Alignment Display (Housing).....	14
6.4	Tightening torques.....	15
7	Connection diagram	16
7.1	Cable glands - clamping ranges.....	16
7.2	Connector pin assignment.....	16
7.3	Wire connection	18
7.3.1	General:	18
7.3.2	Power supply	18
7.3.3	Modbus RTU.....	18
7.3.4	Modbus TCP (Ethernet) Optional PoE	19
7.3.5	Pulse Output	19

8	Operation VA 570	20
8.1	Main menu (Home)	21
8.1.1	Intialization	21
8.2	Main menu	21
8.3	Settings	22
8.3.1	Sensor Setup	22
8.3.1.1	Input / change tube diameter	22
8.3.1.2	Input / change consumption counter	23
8.3.1.3	Definition of the units for flow, velocity, temperature and pressure	23
8.3.1.4	Definition of the reference conditions	24
8.3.1.5	Setting of Zeropoint and Low-flow cut off	26
8.3.2	Modbus RTU	27
8.3.2.1	Setup	27
8.3.3	Modbus TCP (Optional)	28
8.3.3.1	Setup	28
8.3.3.1.1	Network Setup DHCP	28
8.3.3.1.2	Network Settings static IP	29
8.3.3.1.1	Modbus TCP Settings	30
8.3.3.2	Modbus Settings (2001...2005)	31
8.3.3.3	Values Register (1001 ... 1500)	31
8.3.4	Pulse /Alarm	33
8.3.4.1	Pulse output	33
8.3.5	User Setup	34
8.3.5.1	Password	34
8.3.5.2	Language	34
8.3.5.3	Display / Touch	35
8.3.6	Advanced	35
8.3.7	4 -20mA	36
8.3.8	VA 570 Info	38
8.4	MBus	39
8.4.1	Change of communication settings	39
8.4.2	Coding VIF (Value Information Field)	40
8.4.3	Default Settings communication	40
8.4.4	Default values transmitted	40
9	Supplementary Documentation	41

1 Pictograms and Symbols



General Warning symbol (Danger, Warning, Caution)



General note



Installation- and Instruction manual to consider (on Nameplate)



Installation- and Instruction manual to consider

2 Signalwords according ISO 3864 and ANSI Z 535

Danger!	Imminent danger As a consequence of incorrect handling: serious personal injury or death
Warning!	Possible hazard As a consequence of incorrect handling: possible serious injury or death
Caution!	Imminent hazard As a consequence of incorrect handling: possible personal injury or damage
Note!	Possible hazard As a consequence of incorrect handling: possible personal injury or damage
Important!	Additional notes, information, tips As a consequence of incorrect handling: Disadvantages in operation and maintenance, no danger

3 Safety instructions



Please check whether this manual corresponds with the device type.

Please attend to all notes indicated in this instruction manual. It contains essential information, which has to be followed during installation, operation and maintenance. Therefore this instruction manual has to be read categorically by the technician as well as by the responsible user/qualified personnel before installation, initiation and maintenance

Regional and national regulations respectively, have to be observed in addition to this instruction manual if necessary.

This instruction manual has to be available at any time at the operation site of the DS 500.

Ensure that the VA 570 operates within the permissible and listed limits on the nameplate. Otherwise there is a risk to human and material, and it may occur functional and operational disturbances

In case of any obscurities or questions with regard to this manual or the instrument please contact CS Instruments GmbH.



Warning!

Risk of injury in case of inadequate qualification!

Improper handling can result in significant personal injury and damage.

All activities described in this operating instructions manual must be carried out only by qualified personnel qualifications described below.

Professionals (Technical staff)

The technical staff is based on his education/training, his knowledge of measurement and control technology as well of the local regulations, standards and guidelines in the position to do the work as described and to identify the possible hazards.

Special working conditions require further appropriate knowledge, e.g. of aggressive media.



Caution!

Malfunction of VA 570

Faulty installation and insufficient maintenance may lead to malfunctions of the Va 570, which may affect the display and open to misinterpretation.



Danger!

Inadmissible operating parameters!

By exceeding or falling short of limits there is a risk for people and material, in addition there may occur further functional and operational disturbances.

Measures:

- Make sure that the VA 570 operates only within the permissible and listed limits on the nameplate
- Ensure the operation within the performance data of VA 570 in connection with the application
- Do not exceed the admissible storage and transportation temperature.

Additional safety information:

- When installing and operating the relevant national regulations and safety rules must also be observed.



In gas hazardous areas (explosive media) only the version VA 570 EX must be used.

When using the Flow-/ Consumption sensors VA 570 Ex in gas hazardous areas the special requirements specified in the Ex documentation must be observed.

3.1 Intended Use

The instrument described in this manual is exclusively to use for measuring the thermal mass flow of gases. At the same time, the gas temperature is measured too.

The VA 570 can be configured for measuring a predetermined range of pure gases or of gas mixtures.

Consumption measurement of gases such as Air, oxygen, nitrogen, carbon dioxide, argon, etc. and with ATEX approval explosive gases such as natural gas, methane, propane and hydrogen.

Improper or incorrect use the operational reliability will be canceled. The manufacturer is not liable for any damage resulting by improper or incorrect use.

3.2 Installation and commissioning

- Installation, electrical installation, commissioning, operation and maintenance of the device must only be carried by qualified personnel, which were authorized by the plant operator. The personnel must read the operating instructions, understand and follow the instructions.
- If carrying out welding work on the pipeline the grounding of the welding unit is not allowed to be done over the VA570 itself.
- The installer has to ensure that the VA 570 is connected according to the electrical connection diagrams properly. The sensor must be grounded, unless special protective measures have been taken (e.g. galvanically isolated power supply)
- The existing/ applicable national regulations governing opening and repair of the device have to be applied.
- When using the VA 570 (ATEX Version) hazardous areas, in addition with the standard manual a separate Ex documentation is enclosed. The installation instructions and connection values indicated in these must also be observed.
- The device fulfills the general safety requirements in accordance with EN 61010-1, the EMC requirements of IEC / EN 61326 and NAMUR recommendation NE 43.

4 Technical data

Measures:	mass flow, consumption flow speed, temperature
Measuring principle:	thermal mass flow sensor
Medium temperature range:	-40 ... 180°C Probe (ATEX-Version -20°C ... 120°C)
Operating temperature range:	-20 ... 70 °C
Operating pressure:	50 bar
Power supply:	18 ... 36 VDC Optional: PoE according to IEEE 802.3af, PD Class 2 (max. 6.5W), voltage from 36V to 57V DC
Power consumption:	max. 5W
Output:	Modbus RTU (acc. EIA/TIA-485 Standard) 2 x 4...20 mA active (optional passive) RL < 500Ohm galvanically isolated pulse (Pulse weight freely selectable, Alarm max. 48Vdc 0,5A (Relay: Normally Closed) optional: Modbus TCP, HART, Profibus DP, Profinet,
Accuracy: Standard version* (m.v. of meas. value) (f.s. of full scale)	± 1.5 % m.v. ± 0.3 % f.s.
Accuracy: Precision version* (m.v. of meas. value) (f.s. of full scale)	± 1.0 % m.v. ± 0.3 % f.s.
Repeatability :	0.25% m.v in case of correct mounting (mounting aid, position, inlet section
Accuracy indications:	referred to ambient temperature 22°C +/-2°C, system pressure 6bar
Response time:	t90 < 3s
Display:	2" TFT Color Display (320 x 240)
Screw in thread:	G 1/2" ISO 228, NPT 1/2", R 1/2", PT 1/2"
Material:	Housing aluminum die cast, probe stainless steel1,4571
Protection class	IP67

* Reference conditions for Temperature and pressure can be freely set, standard conditions are 0 ° and 1013 mbar.

4.1 Signal circuits

4.1.1 Modbus

- According Standard EIA/TIA-485

4.1.2 Current output

4.1.2.1 Aktive

- Galvanically isolated
- 4 ... 20 mA
- $R_L < 500 \text{ Ohm}$

4.1.2.2 Passive

- Galvanically isolated
- 4 ... 20 mA
- $R_L < 500 \text{ Ohm}$
- $V_{in} 12\text{-}36\text{Vdc}$

4.1.3 Pulse

- Galvanically isolated (dry contact)
- Passive: 48Vdc , 500 mA
- Max. pulse output freq. 50Hz

4.1.4 Alarm

- Galvanically isolated (dry contact)
- Max. 48Vdc, 500mA

4.2 Measuring range flow VA 570

	1/2"	3/4"	1"	1 1/4"	1 1/2"	2"	2 1/2"	3"
	Analog output 20mA	Analog output 20mA	Analog output 20mA	Analog output 20mA	Analog output 20mA	Analog output 20mA	Analog output 20mA	Analog output 20mA
	[m ³ /h]	[m ³ /h]	[m ³ /h]	[m ³ /h]	[m ³ /h]	[m ³ /h]	[m ³ /h]	[m ³ /h]

Reference DIN1945/ ISO 1217: 20°C, 1000 mbar (Reference during calibration)

Air	Low Speed	20	45	75	140	195	320	550	765
	Standard	45	85	145	265	365	600	1025	1420
	Max	90	175	290	530	730	1195	2050	2840
	High Speed	110	215	355	640	885	1450	2480	3440

Adjustment to DIN 1343: 0°C, 1013,25 mbar

Air	Low Speed	20	40	70	130	180	295	505	705
	Standard	40	80	135	240	335	550	945	1305
	Max	80	160	270	485	670	1100	1885	2610
	High Speed	100	195	325	590	815	1330	2280	3165
Argon (Ar)	Low Speed	35	75	120	220	305	505	865	1200
	Standard	70	135	230	415	570	935	1605	2225
	Max	140	275	460	830	1140	1870	3205	4440
	High Speed	170	335	555	1005	1385	2265	3880	5380
Carbon dioxide (CO ₂)	Low Speed	20	45	75	140	195	320	545	760
	Standard	45	85	145	260	360	590	1015	1405
	Max	90	175	290	525	720	1185	2030	2810
	High Speed	105	210	350	635	875	1430	2455	3405
Nitrogen (N ₂)	Low Speed	20	40	70	130	180	295	505	705
	Standard	40	80	135	240	335	550	945	1305
	Max	80	160	270	485	670	1100	1885	2610
	High Speed	100	195	325	590	815	1330	2280	3165
Oxygen f (O ₂)	Low Speed	20	45	75	135	185	305	525	730
	Standard	40	80	140	250	345	570	980	1355
	Max	85	165	280	505	695	1140	1955	2710
	High Speed	105	205	340	610	845	1380	2365	3280
Nitrous oxide (N ₂ O)	Low Speed	20	45	75	140	190	315	540	750
	Standard	40	85	140	260	355	585	1005	1395
	Max	85	170	285	520	715	1170	2010	2785
	High Speed	105	210	345	630	865	1420	2435	3375
Natural gas (NG)	Low Speed	15	25	45	85	115	190	325	450
	Standard	25	50	85	155	215	355	605	840
	Max	50	105	170	310	430	705	1210	1680
	High Speed	65	125	210	380	520	855	1465	2035

Other gases on request

5 Dimensions

5.1 Dimension VA 570 Thread-version

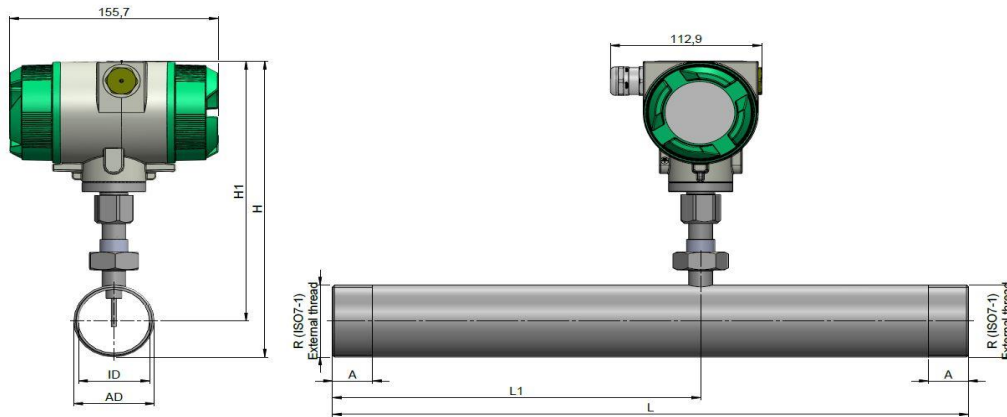

Thread size		OD [mm]	ID [mm]	L [mm]	L1 [mm]	H [mm]	H1 [mm]	A [mm]
1/2"	DN 15	21,3	16,1	300	210	228	218	20
3/4"	DN 20	26,9	21,7	475	275	231	218	20
1"	DN 25	33,7	27,3	475	275	235	218	25
1 1/4"	DN 32	42,4	36	475	275	239	218	25
1 1/2"	DN 40	48,3	41,9	475**	275	242	218	25
2"	DN 50	60,3	53,1	475**	275	248	218	30

Attention: Shortened inlet section! Please observe the recommended minimum inlet section (length = 10x inner diameter)

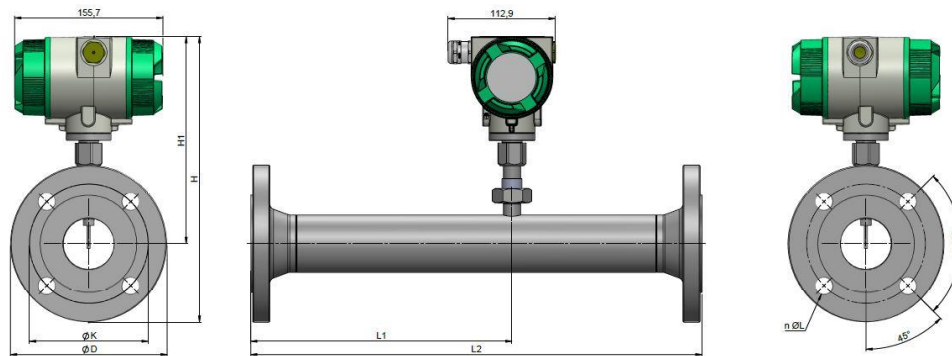
5.2 With measurement section and flange

Measurement Section	AD [mm]	ID [mm]	L [mm]	L1 [mm]	H [mm]	H1 [mm]	Flange DIN EN 1092-1		
							ØD [mm]	ØK [mm]	n x ØL
DN 15	21,3	16,1	300	210	267	218	95	65	4 x 14
DN 20	26,9	21,7	475	275	270	218	105	75	4 x 14
DN 25	33,7	27,3	475	275	275	218	115	85	4 x 14
DN 32	42,4	36	475	275	288	218	140	100	4 x 18
DN 40	48,3	41,9	475**	275	293	218	150	110	4 x 18
DN 50	60,3	53,1	475**	275	300	218	165	125	4 x 18
DN 65	76,1	68,9	475**	275	320	228	185	145	8 x 18
DN 80	88,9	80,9	475**	275	328	228	200	160	8 x 18

Attention: Shortened inlet section! Please observe the recommended minimum inlet section (length = 10x inner diameter)

6 Installation

6.1 Pipe/tube requirements

- Correctly sized gaskets
- Correct aligned flanges and gaskets
- Diameter mismatch at the pipe junctions should be avoided but must be less than 1mm.
For further information see ISO 14511
- Ensure clean pipes after installation

6.2 Inlet / outlet runs

The principle of thermal Mass flow measurement is very sensitive against disturbances. Therefore, it is necessary to ensure the recommended inlet and outlet runs.

Table Inlet / Outlet runs

Flow obstruction before the measurement section	Min length Inlet run (L1)	Min length Outlet run (L2)
Slight curve (ellbow < 90°)	12 x D	5 x D
Reduction (Pipe narrows to the measurement section)	15 x D	5 x D
Expansion (Pipe expands to the measurement section)	15 x D	5 x D
90° ellbow or T-piece	15 x D	5 x D
2x ellbow á 90° in einer Ebene	20 x D	5 x D
2x ellbow á 90° 3-dimensional	35 x D	5 x D
Control valve	45 x D	5 x D

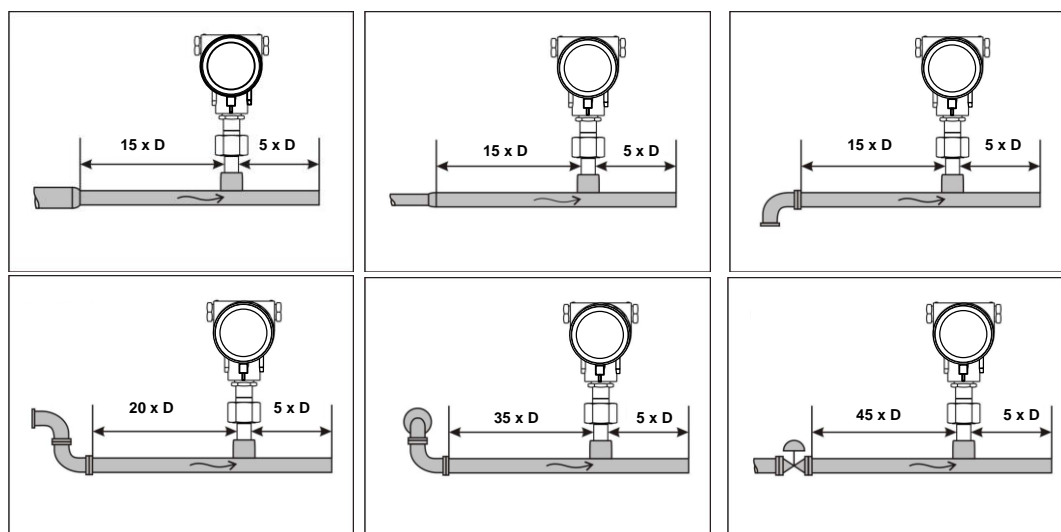

The values represent the min.lengths. In case the min. inlet / outlet runs could not be ensured, it must be expected to get increased or significant deviations of the measurement values.

6.2.1 Installation of VA 570

The sensor VA 570 is pre-supplied with the measuring section.



An installation at customer site is only allowed in the unpressurized state of the system

The connecting nut is tightened to a torque of 25 -30 Nm.

Tightness of the connection must be checked and ensured.

Important: Please check flow direction, see therefore label on measuring section and pictures of chapter 5.1 and chapter 5.2

6.3 Alignment Display (Housing)

The sensor housing VA 570 can be turned in both directions, max. 345 °. For this purpose, the housing-connecting nut must be opened. The housing can be rotated to the desired position, a bigger rotation angle is prevented by internal stop pins.

After that, the housing-connecting nut is firmly retighten

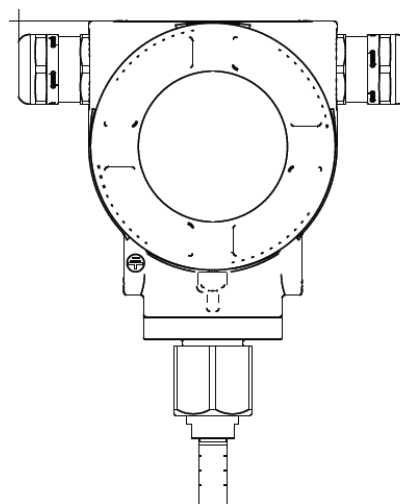
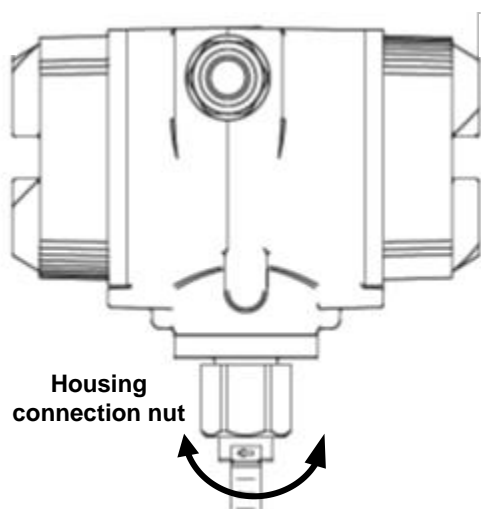

Loosen the housing connection nut only, do not unscrew it completely!

6.4 Tightening torques

To secure and guarantee of the function and tightness following tightening torques have to be applied, see table 1.

Description	Tightening torque [Nm]
VA570 Cover with glass	3
VA570 Cover closed	3
Grub screw with hexagon socket M4x6 DIN 914 A2	2
Housing connection nut	15
Cable glands	8

Table 1

7 Connection diagram

7.1 Cable glands - clamping ranges

For ensuring the tightness and strain relief, connector cables with the following diameters must be used.

VA570 Standard clamping range : Ø5-9mm

VA570 Ex clamping range: Ø5-10mm

7.2 Connector pin assignment

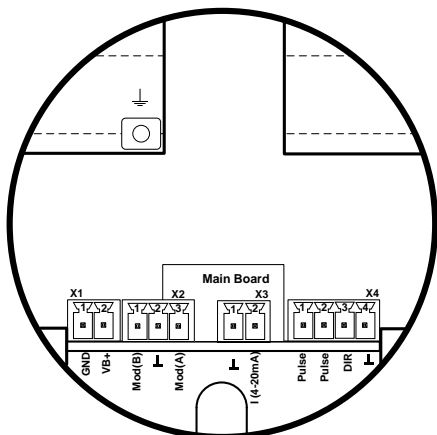

Standard version with 1x analogue output (not galvanically isolated)

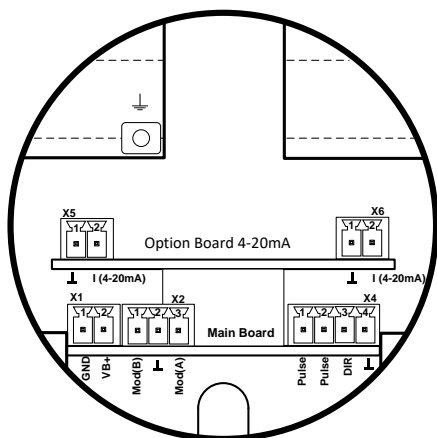

Version with option board 2x analogue outputs galvanically isolated

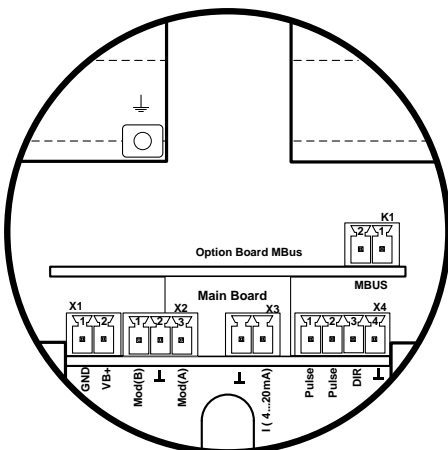

Version with option board MBUS

Connector	Pin	Signal description
X1 Power supply	1	VB - (GND)
	2	VB+
X2 Modbus	1	Modbus (B)
	2	Modbus shield
	3	Modbus (A)
X3 Current output	1	I- Active
	2	I+ Active
X4 Direction / Pulse	1	Pulse / Alarm *
	2	Pulse / Alarm *
	3	Direction input
	4	GND
X5 Current output 1	1	I- Active**
	2	I+ Active **
X6 Current output 2	1	I- Active **
	2	I+ Active **
K1 Mbus	1	Mbus
	2	Mbus

* Outputs are galvanically isolated.

** The Current outputs, X5 and X6, are optional.(Active and passive version available).

7.3 Wire connection

7.3.1 General:

- Wiring to be done in strainless state only.
- Length of cable skinning to be minimized
- Not used cable entries must be closed with end caps
- Use of cables with cross section of $\geq 0.25\text{mm}^2$

7.3.2 Power supply

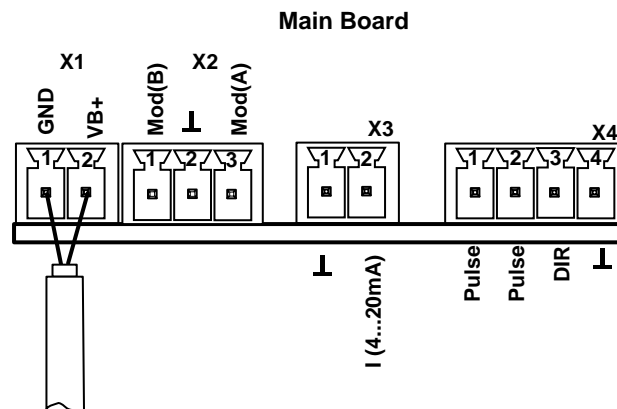

7.3.3 Modbus RTU

If the sensor placed at the end of the Modbus system a termination is required.

Therefore the enclosed 120R resistor is to be connected at Pin 1 and Pin 3 of connector „X2“

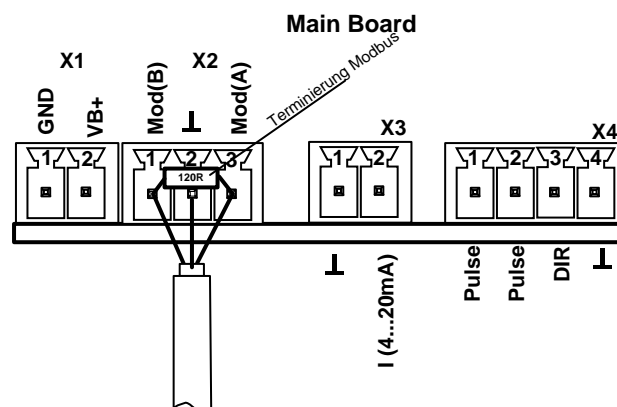

7.3.4 Modbus TCP (Ethernet) Optional PoE

M12 x-coded

Data LINES: 1,2 und 3,4

PoE LINES: 5,6 und 7,8

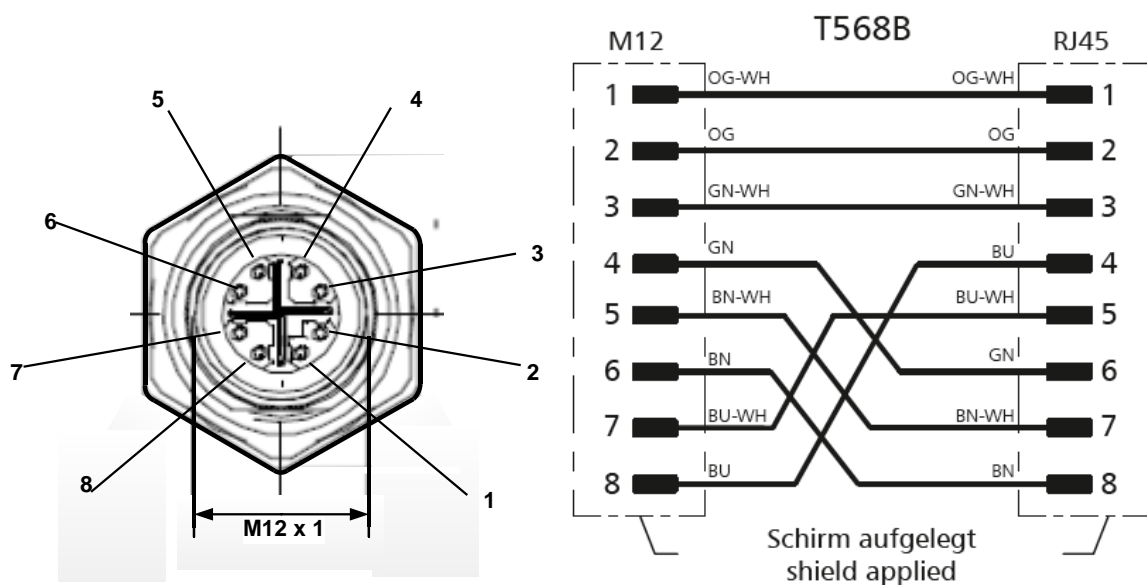

Connection cable: Cat 6.

*PoE: Power over Ethernet

7.3.5 Pulse Output

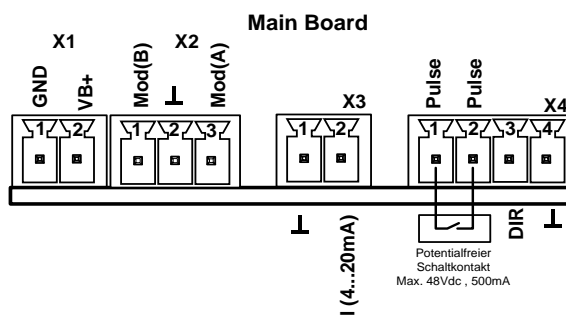

8 Operation VA 570

Remark: Only for version with display

The operation of the VA 570 are carried out by 2 optical keys through the glass cover Thus, the VA 570 can be operated from the outside without opening the cap.

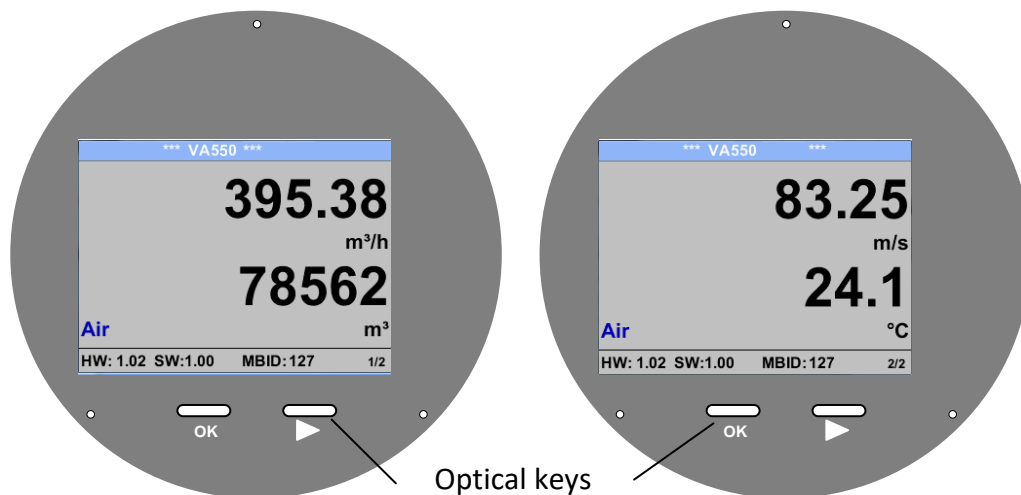

Selection of the individual menu items is done by pressing the ">" and confirm by pressing "OK".

Inputs or changes can be made with all white deposit fields, selcted filed will be highlighted with yellow background.

Words in **green font** refer mainly to the pictures in the section of the chapter, but also on important menu paths or menu items that are related to are in **green font**.

The menu navigation is generally in a **green font**!

The table of contents and chapter references in **blue font** contain links to the respective chapter title.

8.1 Main menu (Home)

8.1.1 Initialization

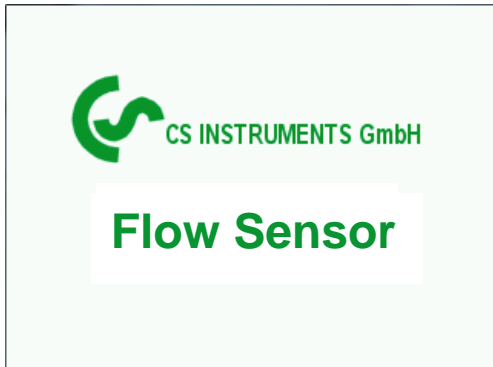

After switching on the VA 570, the initialized screen is displayed followed by the main menu.

8.2 Main menu

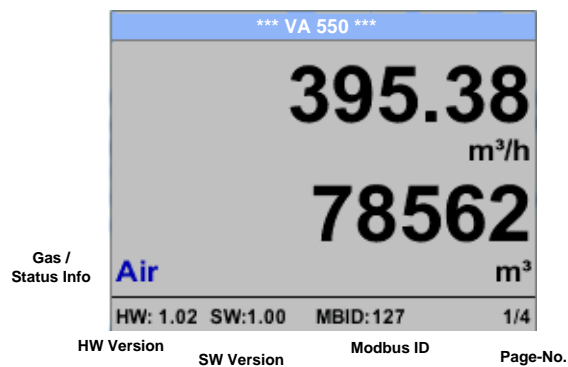

Switching to pages 2-4 or back by pressing key „>“

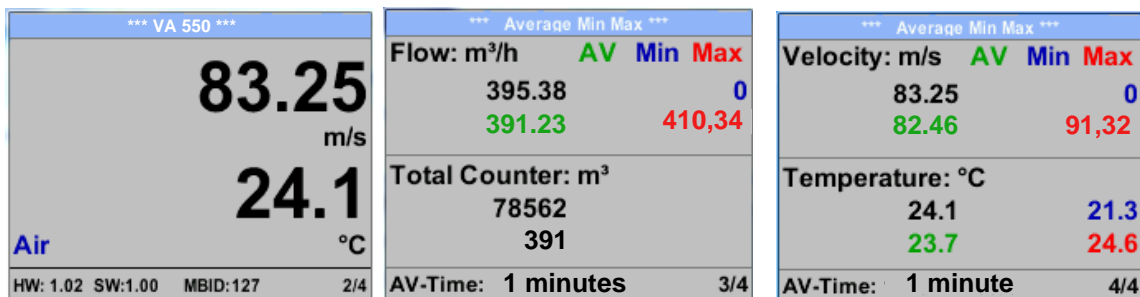

AV-Time (Period for average value calculation) could be changed under [Sensor Setup.-Advanced- AV-Time](#)

8.3 Settings

The settings menu could accessed by pressing the key „OK“.

But the access to the *settings menu* is password protected.



Factory settings for password at the time of delivery: 0000 (4 times zero).

If required the password could be changed at *Setup–User setup-Password*.

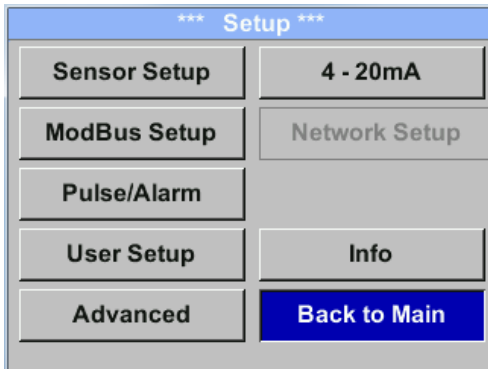

Selection of a menu item or to change a value is done with the key „>“, a final move to the chosen menu item or takeover of the value change needs the confirmation by pressing the key „OK“

8.3.1 Sensor Setup

Setup → Sensor Setup

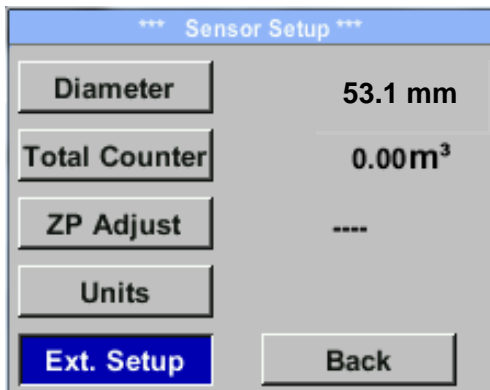

For changes, first select the menu item with key „>“ and then confirm it with “OK“.

8.3.1.1 Input / change tube diameter

For VA 570 not adjustable (suspended) as voted on included measuring section with corresponding pipe diameter.

8.3.1.2 Input / change consumption counter

Setup → Sensor Setup → Total Counter → Unit button

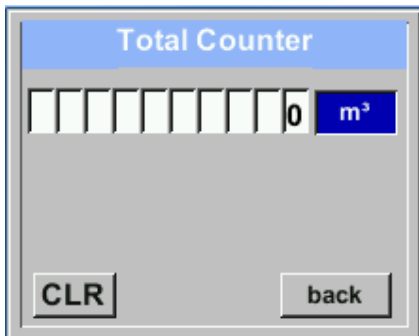
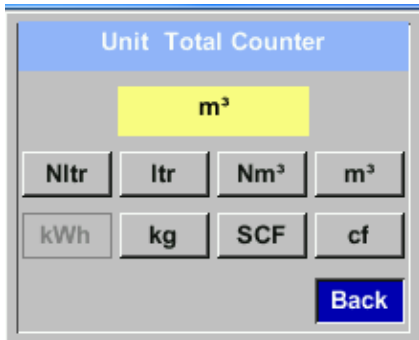

In order to change, e.g. the unit, first select by pressing key „>“ the button **“Unit”** and then key **“OK”**.

Select with the key „>“ the correct unit and then confirm selection by pressing 2x **„OK”**.

Entering / changing the consumption counter via button „>“, select the respective position and activate the position with the **“OK”** button.

By pressing „>“ the position value is incremented by 1. Complete with **“OK”** and activate next number position.

Confirm entry by pressing **„OK”**.

Important!

When the counter reach 100000000 m³ the counter will be reset to zero.

8.3.1.3 Definition of the units for flow, velocity, temperature and pressure

Setup → Sensor Setup → Units

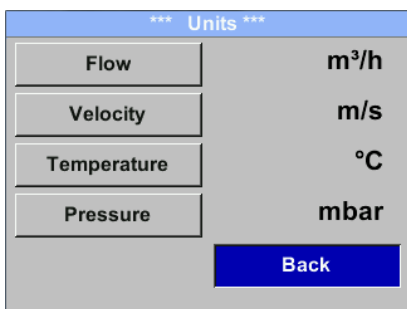

To make changes to the unit for the respective measurement value, first select by pressing „>“ the field of the „measurement value“ and activate „it with **„OK”** .

Selection of the new unit with **„>“**

In case the quantity of units selectable are not presentable on one page, pleas move to next page by pressing **„<<“** .

Confirm selection by pressing 2x **„OK”**.

Procedure for all 4 measurement-variables is analogous.

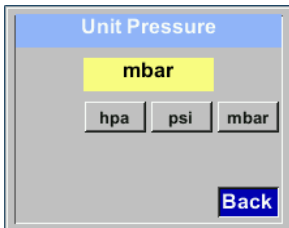
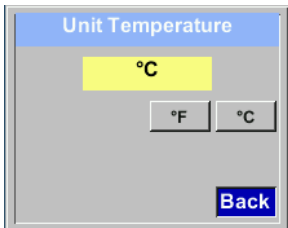
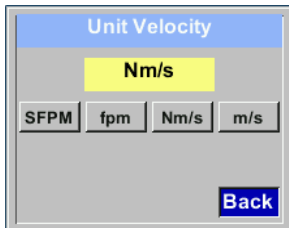
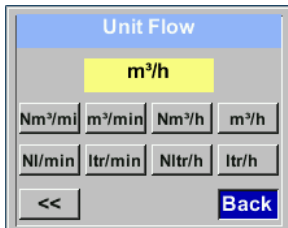

8.3.1.4 Definition of the reference conditions

Here can be defined the desired measured media reference conditions for pressure and temperature and times for the filter and averaging.

- Factory pre-setting for reference temperature and reference pressure are 20 °C, 1000 hPa
- All volume flow values (m³/h) and consumption values indicated in the display are related to 20 °C and 1000 hPa (according to ISO 1217 intake condition)
- Alternatively 0 °C and 1013 hPa (=standard cubic meter) can also be entered as a reference.
- **Do not enter the operation pressure or the operation temperature under reference conditions!**

Setup → Sensor Setup → Advanced

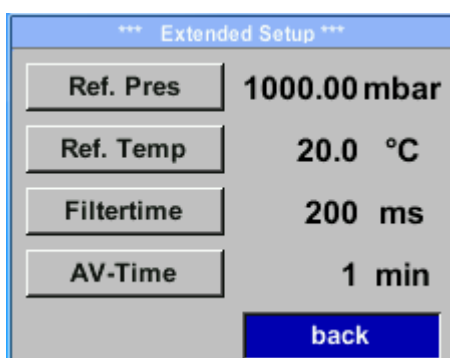

To make changes, first select a menu with button „>“ and confirm selection by pressing „OK“.

Setup → Sensor Setup → Advanced → Ref.Pref



In order to change, e.g. the unit, first select by pressing key „>“ the field **“Units”** and then key **“OK”**.

Select with the key „>“ the correct unit and then confirm selection by pressing 2x **„OK”**.

Input / change of the value by selecting the respective position with button „>“ and entering by pressing button **„OK”**.

Setup → Sensor Setup → Advanced → Ref.Temp

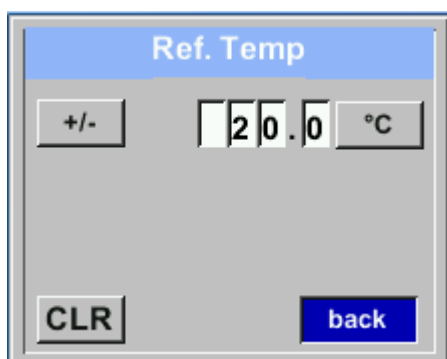

By pressing „>“ the position value is incremented by 1. Complete with **“OK”** and activate next number position.

Procedure for changing the reference temperature is the same.

Setup → Sensor Setup → Advanced → *Filtertime*



Under item "*Filtertime*" an attenuation can be defined.
Input values of 0 -10000 in [ms] are possible

Setup → Sensor Setup → Advanced → *AV-Time*

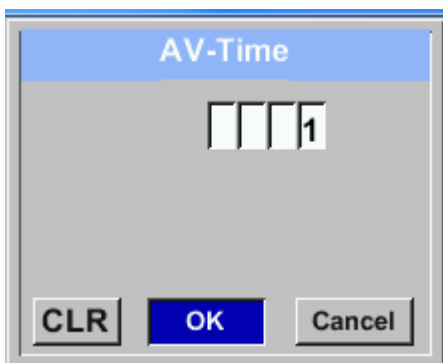

The time period for averaging can be entered here.
Input values of 1-1440 [minutes] are possible.
For average values see display window 3 + 4

8.3.1.5 Setting of Zeropoint and Low-flow cut off

Setup → Sensor Setup → ZP Adjust

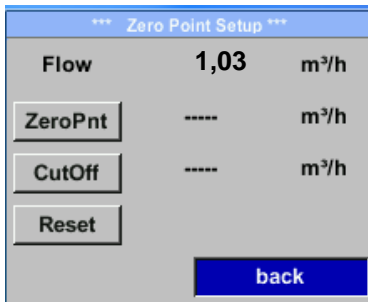

To make changes, first select a menu with button „>“ and confirm selection by pressing „OK“.

Setup → Sensor Setup → ZP Adjust → ZeroPnt

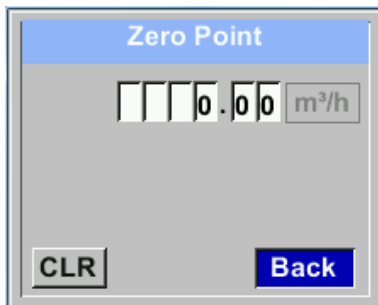

When, without flow, the installed sensor shows already a flow value of > 0 m³/h herewith the zero point of the characteristic could be reset.

For an input / change of the value select with the button „>“ the respective number position and activate it with „OK“.

By pressing „>“ the position value is incremented by 1. Confirm the input with „OK“ and activate next number position.

Leave menu with button „Back“

Setup → Sensor Setup → ZP Adjust → CutOff

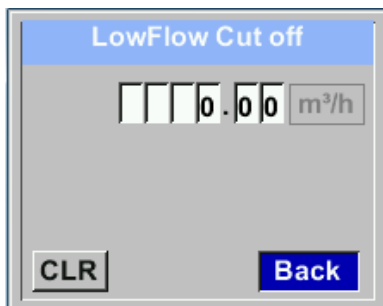

With the low-flow cut off activated, the flow below the defined "LowFlow Cut off" value will be displayed as 0 m³/h and not added to the consumption counter.

For an input / change of the value select with the button „>“ the respective number position and activate it with „OK“.

By pressing „>“ the position value is incremented by 1. Confirm the input with „OK“ and activate next number position.

Leave menu with button „Back“

Setup → Sensor Setup → ZP Adjust t → Reset

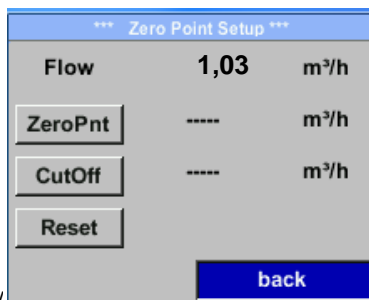

By selection of „Reset“ all settings for „ZeroPnt“ and „CutOff“ are reset.

Menu item to be select with button „>“ and confirm the reset with „OK“.

Leave menu with button „Back“

8.3.2 Modbus RTU

8.3.2.1 Setup

The Flow sensors VA 570 comes with a Modbus RTU Interface. Before commissioning the sensor the communication parameters

- Modbus ID, Baudrate, Parity und Stop bit

must be set in order to ensure the communication with the Modbus master.

Settings → Modbus Setup

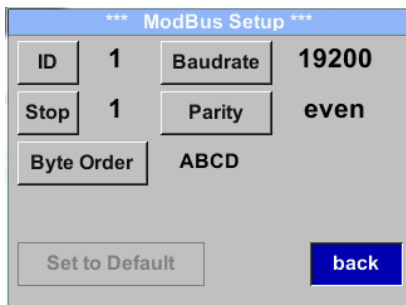
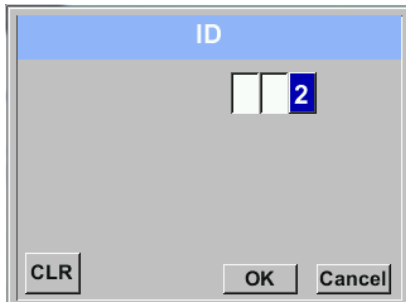
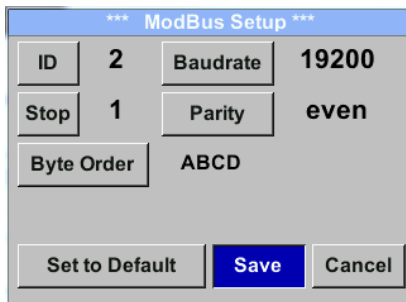
For changes, e.g. the sensor ID, select with key „**Δ**“ the field “**ID**” and then pressing “**OK**”.

Select the desired position by pressing the “**>**” and select with “**OK**” button.

Change values by pressing the „**Δ**“ values takeover by pressing “**OK**”.

Inputs for baudrate, stopbit and parity is done analogue.

By means of the button "Byte Order" it is possible to change the data format (Word Order). Possible formats are "ABCD" (Little Endian) and "CDAB" (Middle Endian)

Saving the changes by pressing “**Save**”, therefore select it with key „**Δ**“ and then confirm it with “**OK**”.

Default values out of factory:

Modbus ID:	1
Baud rate:	19200
Stopbit:	1
Parity:	even
Byte Order:	ABCD

Remark: If the sensor placed at the end of the Modbus system a termination is required.

Therefore the enclosed 120R resistor is to be connected at Pin 1 and Pin 3 of connector „X2“

8.3.3 Modbus TCP (Optional)

8.3.3.1 Setup

The Flow sensors VA 550 comes optional with a Modbus TCP Interface (HW Interface:M12 x 1 X-coded connector).

Device supports with this option the Modbus TCP protocol for communication with SCADA systems. TCP port is set to 502 by default. Port can be changed at the sensor or using PC Service Software

Modbus device address (Unit Identifier) can be set in the range of 1- 255. Specification and description of the Modbus protocol is free to download on: www.modbus.org.

Supported Modbus commands (functions):

Command	Code	Description
Function Code	3	(Read holding register)
Function code	16	(Write multiple registers)

For more details, please see **VA 5xx Modbus RTU_TCP Installation V1.04**

Settings → Network Setup

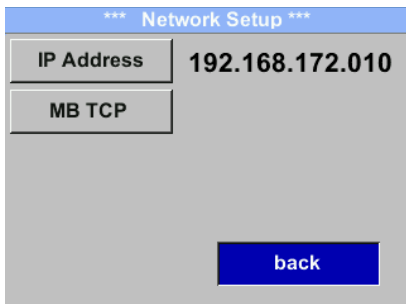

8.3.3.1.1 Network Setup DHCP

Settings → Network Setup Settings → IP Address

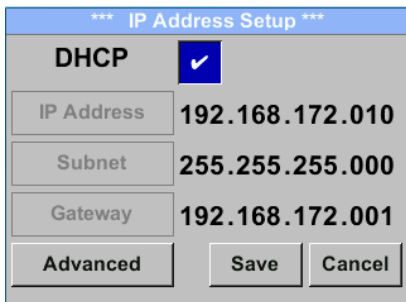

Here you can set up and made a connection, with or without **DHCP**, to a computer.

Remark:
With activated **DHCP** the automatic integration of the sensor in an existing network is possible, without a manual configuration.

Storing of settings by pressing **“Save”**

8.3.3.1.2 Network Settings static IP

Settings → Network Setup Settings → IP Address → IP Address

Settings → Network Setup Settings → IP Address → Subnet

Settings → Network Setup Settings → IP Address → Gateway

*** IP Address Setup ***

DHCP

IP Address 192.168.172.010

Subnet 255.255.255.000

Gateway 192.168.172.001

Advanced back

*** IP Address Setup ***

DHCP

IP Address 192.168.172.010

Subnet 255.255.255.000

Gateway 192.168.172.001

Advanced back

IP Setup

1 9 2

CLR back

Subnet Setup

2 5 5

CLR back

Gateway Setup

1 9 2

CLR back

*** IP Address Setup ***

DHCP

IP Address 192.168.172.011

Subnet 255.255.255.000

Gateway 192.168.172.001

Advanced Save Cancel

For manual (static) IP, the **"IP Address"**, **"Subnet"** and **"Gateway"** selection keys must be selected and activated with **"OK"**.

The first data field of the selection, in this case the IP address, is then marked (red).

Confirm with **"OK"** the corresponding input menu is opened.

By means of **">"**, the next data field is changed.

Select the desired position with the **">"** key and activate it with the **"OK"** key.

Change the values with the **">"** key, and accept the values with the **"OK"** key.

Procedure for **"Subnet"** and **"Gateway"** is analogous.

Store the settings by **„Save“**

8.3.3.1.1 Modbus TCP Settings

Settings → Network Setup Settings → IP Address → MB TCP

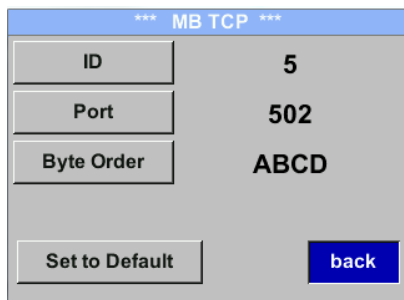

*** MB TCP ***	
ID	5
Port	502
Byte Order	ABCD
<div style="display: flex; justify-content: space-between;"> Set to Default back </div>	

Settings → Network Setup Settings → IP Address → ID

Settings → Network Setup Settings → IP Address → Port

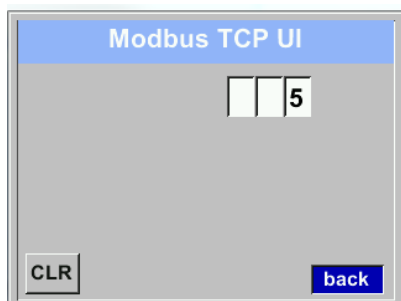

Modbus TCP UI	
<input type="text" value="5"/>	
<div style="display: flex; justify-content: space-between;"> CLR back </div>	

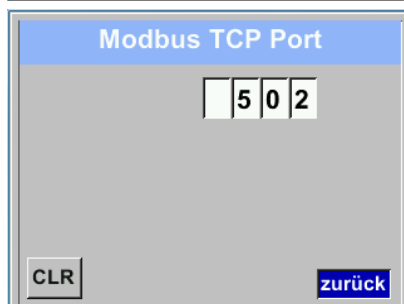

Modbus TCP Port	
<input type="text" value="502"/>	
<div style="display: flex; justify-content: space-between;"> CLR zurück </div>	

For changes, e.g. the sensor ID, select with key „>“ the field “ID” and then pressing “OK”.

Select the desired position by pressing the “>” and select it with “OK” button.

Change values by pressing the „>“ values takeover by pressing “OK”.

Input for the port is done analogue.

By means of the button “Byte Format” it is possible to change the data format (Word Order). Possible formats are “ABCD” (Little Endian) and “CDAB” (Middle Endian)

Saving the changes by pressing “Save”, therefore select it with key „>“ and then confirm it with “OK”.

Reset to the default settings by activating “Set to Default”-

8.3.3.2 Modbus Settings (2001...2005)

Modbus Register	Register Address	No. of Byte	Data Type	Description	Default Setting	Read Write	Unit /Comment
2001	2000	2	UInt16	Modbus ID	1	R/W	Modbus ID 1...247
2002	2001	2	UInt16	Baudrate	4	R/W	= 1200 1 = 2400 2 = 4800 3 = 9600 4 = 19200 5 = 38400 6 = 57600 7 = 115200
2003	2002	2	UInt16	Parity	1	R/W	0 = none 1 = even 2 = odd
2004	2003	2	UInt16	Number of Stopbits		R/W	0 = 1 Stop Bit 1 = 2 Stop Bit
2005	2004	2	UInt16	Word Order	0xABCD	R/W	0xABCD = Big Endian 0xCDAB = Middle Endian

8.3.3.3 Values Register (1001 ...1500)

Modbus Register	Register Address	No. of Byte	Data Type	Description	Default	Read Write	Unit /Comment
1101	1100	4	Float	Flow in m ³ /h		R	
1109	1108	4	Float	Flow in Nm ³ /h		R	
1117	1116	4	Float	Flow in m ³ /min		R	
1125	1124	4	Float	Flow in Nm ³ /min		R	
1133	1132	4	Float	Flow in ltr/h		R	
1141	1140	4	Float	Flow in Nltr/h		R	
1149	1148	4	Float	Flow in ltr/min		R	
1157	1156	4	Float	Flow in Nltr/min		R	
1165	1164	4	Float	Flow in ltr/s		R	
1173	1172	4	Float	Flow in Nltr/s		R	
1181	1180	4	Float	Flow in cfm		R	
1189	1188	4	Float	Flow in Ncfm		R	
1197	1196	4	Float	Flow in kg/h		R	
1205	1204	4	Float	Flow in kg/min		R	
1213	1212	4	Float	Flow in kg/s		R	
1221	1220	4	Float	Flow in kW		R	

Modbus Register	Register Address	No. of Byte	Data Type	Description	Default	Read Write	Unit /Comment
1269	1268	4	UInt32	Consumption m ³ before comma	x	R	
1275	1274	4	UInt32	Consumption Nm ³ before comma	x	R	
1281	1280	4	UInt32	Consumption ltr before comma	x	R	
1287	1286	4	UInt32	Consumption Nltr before comma	x	R	
1293	1292	4	UInt32	Consumption cf before comma	x	R	
1299	1298	4	UInt32	Consumption Ncf before comma	x	R	
1305	1304	4	UInt32	Consumption kg before comma	x	R	
1311	1310	4	UInt32	Consumption kWh before comma	x	R	
1347	1346	4	Float	Velocity m/s			
1355	1354	4	Float	Velocity Nm/s			
1363	1362	4	Float	Velocity Ft/min			
1371	1370	4	Float	Velocity NFt/min			
1419	1418	4	Float	GasTemp °C			
1427	1426	4	Float	GasTemp °F			

Remark:

- **For DS400 / DS 500 / Handheld devices - Modbus Sensor Datatype**
„Data Type R4-32“ match with „Data Type Float“
- For more additional Modbus values please refer to
VA5xx_Modbus_RTU_TCP_Installation_1.06_EN.doc

8.3.4 Pulse /Alarm

Setup → Sensor Setup → Pulse/ Alarm

Relay Mode:	Alarm	
Unit	°C	
Value	20.0	
Hyst.	5.0	
Hi-Lim.	OK	Cancel

*** Pulse / Alarm ***		
Relay Mode:	Alarm	
Unit:	°C	
Value	20.0	
Hyst.	5.0	
Hi-Lim.	OK	Cancel

*** Pulse / Alarm ***		
Relay Mode:	Pulse	
Unit:	m ³	
Value	0.1	
Polarity	pos.	
Pls per second at max Speed: 0		
		Back

The galvanically isolated output can be defined as pulse- or alarm output. Selection of field „**Relay Mode**” with key „>” and change modus by pressing key „OK”.

For alarm output following units could be chosen: kg/min, cfm, ltr/s, m³/h, m/s, °F, °C and kg/s.

„**Value**” defines the Alarm value, „**Hyst.**” defines the desired hysteresis and with „**Hi-Lim**” or „**Lo-Lim**” the alarm settings when the alarm is activated

Hi-Lim: Value over limit

Lo-Lim: Value under limit

For the pulse output following units could be chosen: kg, cf, ltr and m³.

The pulse value definition to be done in menu „**Value**”(0.1, 1, 10, 100).

With „**Polarity**” the switching state could be defined.

Pos. = 0 → 1 neg. 1 → 0

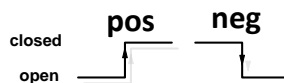

8.3.4.1 Pulse output

The maximum frequency for pulse output is 50 pulses per second (50Hz).

The Pulse output is delayed by 1 second.

Pulse value	[m ³ /h]	[m ³ /min]	[l/min]
0.1 ltr / Pulse	18	0,3	300
1ltr / Pulse	180	3	3000
0.1m ³ / Pulse	18000	300	300000
1 m ³ / Pulse	180000	3000	3000000

Table 1 Maximum flow for pulse output

Entering pulse values that are not allow a presentation to the full scale value, are not allowed. Entries are discarded and error message displayed.

8.3.5 User Setup

8.3.5.1 Password

Settings → UserSetup → Password



To make changes, first select a menu with button „>“ and confirm selection by pressing „OK“.

It is possible to define a password. The required password length is 4 digits. Please select with button „>“ a figure and confirm it with „OK“. Repeat this 4 times.

With „<“ the last figure could be deleted. Password input have to be inserted twice.

Confirmation of input/password by pressing „OK“.

Factory settings for password at the time of delivery: 0000 (4 times zero).

8.3.5.2 Language

Settings → UserSetup → Language

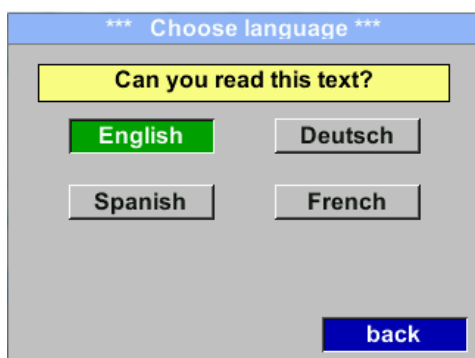

Currently 4 languages have been implemented and could be selected with button „>“.

Change of language by confirming with “OK”. Leaving the menu with button “back”.

8.3.5.3 Display / Touch

Settings → UserSetup → Display / Touch

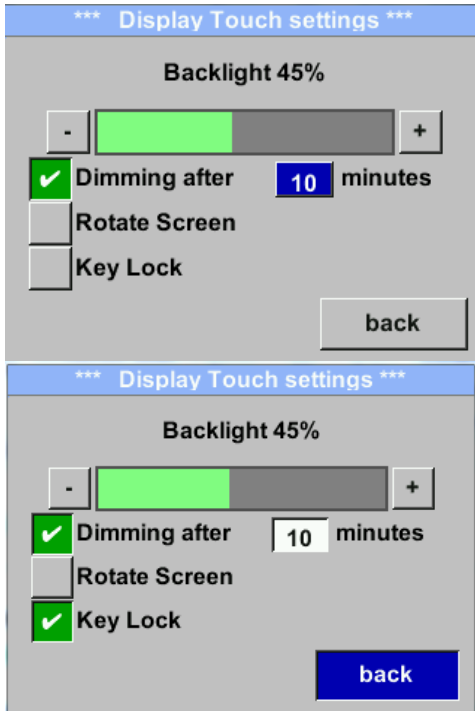

With the button „-“ and with button „+“ it is possible to adjust the backlight / display brightness. The actual / adjusted backlight brightness is showed in the graph „**Backlight.**“

By activation **“Dimming after”** and entering a time a display dimming could be set.

With **„Rotate Screen“** the display information could be rotated by 180°.

By activation of **„Key Lock“** the operation of the sensor locked.

Unlocking the keyboard is only possible by restarting the sensor and calling the operating menu within the first 10s. To do this, use the **“OK”** button to enter the operating menu during this period

8.3.6 Advanced

Settings → Advanced

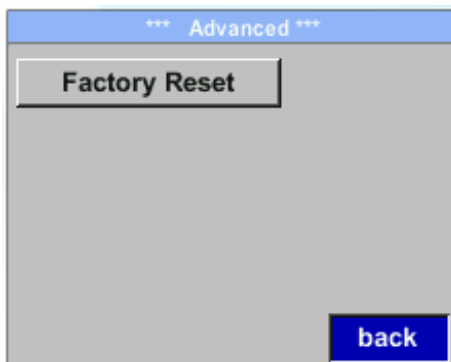

By pressing **„Factory Reset“** the sensor is set back to the factory settings.

8.3.7 4 -20mA

Settings → 4-20mA

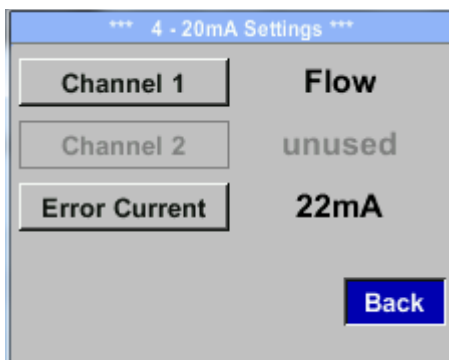

To make changes, first select a menu with button „>“ and confirm selection by pressing „OK“.

Settings → 4-20mA → Channel 1

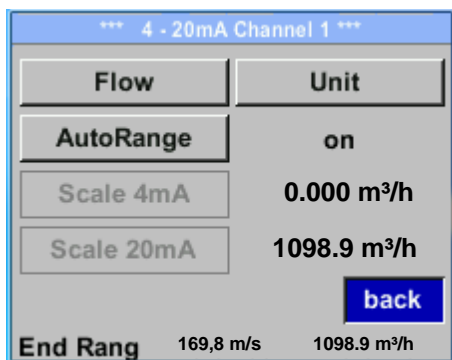

The 4-20 mA Analogue output of the Sensor VA 570 can be individually adjusted.

It is possible to assign following values „Temperature“, „Velocity“ und „Flow“ to the channel CH 1.

To make changes, first select the value item with button „>“ and confirm.

Moving between the different measurements values or to deactivate the 4-20mA with setting to „unused“ by pressing „OK“.

To the selected measurement value a corresponding / appropriate unit needs to be defined. Select „Unit“ with „>“ and open menu with „OK“.

Select required unit with „>“ and take over by pressing „OK“.

Here e.g. for the measurement value Flow, procedure for the other measurements values is analog.

For saving the changes done press button „Save“ to discard the changes press button „Cancel“.

Leaving the menu with „Back“.

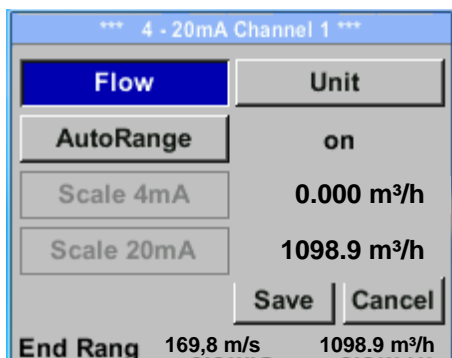
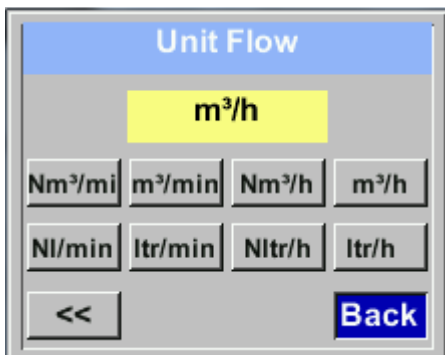

Settings → 4-20mA → Channel 1 → AutoRange

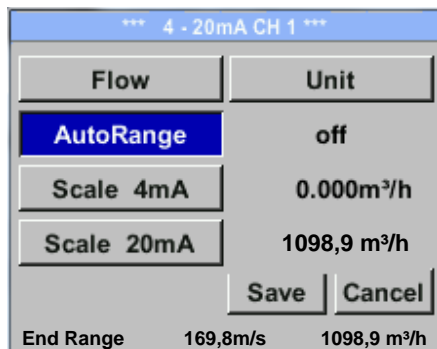

Flow	Unit
AutoRange	off
Scale 4mA	0.000m³/h
Scale 20mA	1098,9 m³/h
End Range	169,8m/s 1098,9 m³/h

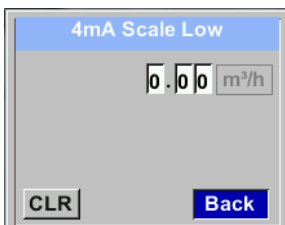

4mA Scale Low

0.00 m³/h

CLR Back

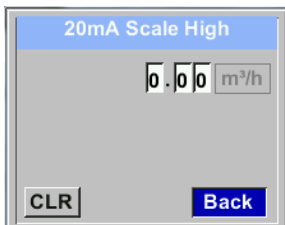

20mA Scale High

0.00 m³/h

CLR Back

The scaling of the 4-20mA channel can be done automatically "Auto Range = on" or manual "AutoRange = off" .

With button „>“ select the menu item „AutoRange“ select with „OK“ the desired scaling method. (Automatically or manually)

In case of **AutoRange = off** with „Scale 4mA“ und „Scale 20mA“ the scale ranges needs to be defined.

Select with button „>“ the item „Scale 4mA“ or „Scale 20mA“ and confirm with „OK“ .

Input of the scaling values will be analogous as described before for value settings.

Using „CLR“ clears up the complete settings at once.

For „Auto on“ , the max. scaling is calculated based on the inner tube diameter, max. measurement range and the reference conditions settings.

Take over of the inputs with „Save“ and leaving the menu with „Back“.

Settings → 4-20mA → Error Current

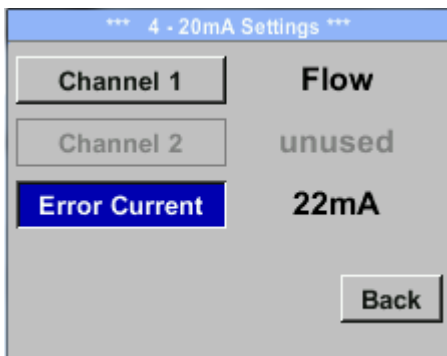

Channel 1	Flow
Channel 2	unused
Error Current	22mA

Back

This determines what is output in case of an error at the analog output.

- 2 mA Sensor error / System error
- 22 mA Sensor error / System error
- None Output according Namur (3.8mA – 20.5 mA)
 < 4mA to 3.8 mA Measuring range under range
 >20mA to 20.5 mA Measuring range exceeding

To make changes first select a menu item "Current Error" with button „>“ and then select by pressing the „OK“ the desired mode

For saving the changes done press button „Save“ to discard the changes press button „Cancel“.

Leaving the menu with „Back“.

Remark: Default setting VA 570 for analogue output is Channel 1:0...max. flow [m³/h]
 Default settings for VA570 with option board analogue output Channel 1:0...max. flow [m³/h]
 Channel 2: -20°C ... 100°C]

For max. flow see label on Sensor.

8.3.8 VA 570 Info

Setup → Sensor Setup → Info

*** Info ***	
Production Datas	
Serial No.:1234567890	Details
Cal. Date: 10.01.2013	
Sensor Datas	
Sensor Type: IST 1.8	
Max Speed: 92,7 m/s 600m³/h	
Max Temp: 100.0 °C	
Live Datas	
Run Time: 2d 21h 23m 12s	
Vin: 23,8V	Temp: 35,8
Options	Back

*** Calibration Details ***	
Calibration Conditions	
Ref. Pressure:	1000.00mbar
Ref. Temperature:	20 °C
Cal. Diameter:	53,1 mm
Cal. Pressure:	6000.00mbar
Cal. Temperature:	23 °C
Cal. Points:	10
Back	

Here you get a brief description of the sensor data incl. the calibration data.

Under **Details**, you are able to see in addition the calibration conditions.

8.4 M-Bus

8.4.1 Change of communication settings

The communication settings Primary-address and baud rate could be changed directly at the sensor, in case sensor has a display, or with the CS Service software (Order-No. 0554 2007).

Settings → M-Bus

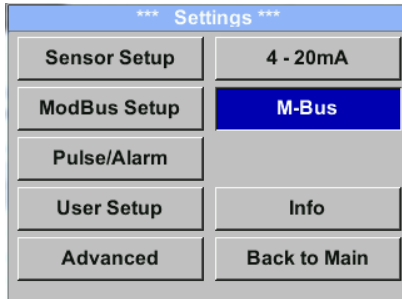

Settings → M-Bus → Adr

Possible inputs are values from 1-255 (Default setting = 1)

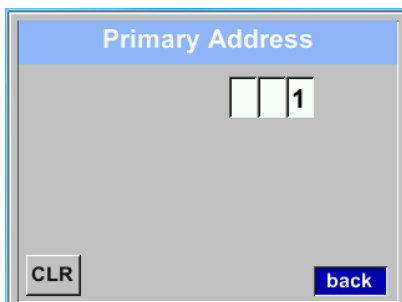
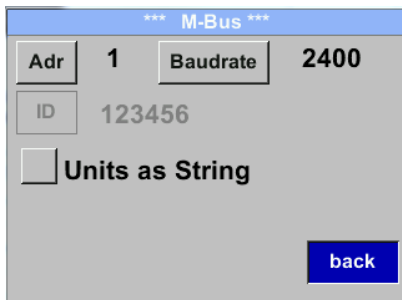

With „>“ select the button „Adr“ and confirm it with „OK“.
 Select the desired position by pressing the button „△“ and select it with "OK" button.

Change values by pressing „>“ with step of 1, taking the value by confirming with "OK".
 Move to next position with „>“

Using „CLR“ clears up the complete settings at once.

For saving the changes done press button „Save“ to discard the changes press button "Cancel".

Leaving the menu with „Back“.

Remark: Secondary address "ID" is not changeable the ID is fixed.

Settings → M-Bus → Baudrate

Possible values are 2400, 4800 and 9600 Baud (Default setting = 2400).

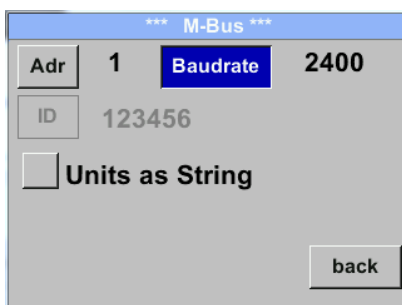

Baudrate change by pressing the button „OK“

For saving the changes done press button „Save“ to discard the changes press button "Cancel".

Leaving the menu with „Back“.

8.4.2 Coding VIF (Value Information Field)

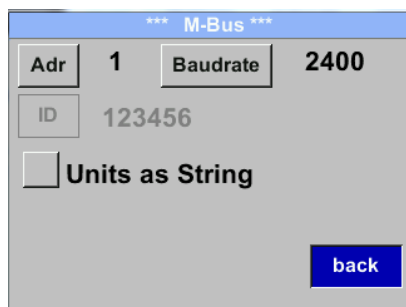

*** M-Bus ***

Adr 1 Baudrate 2400

ID 123456

Units as String

back

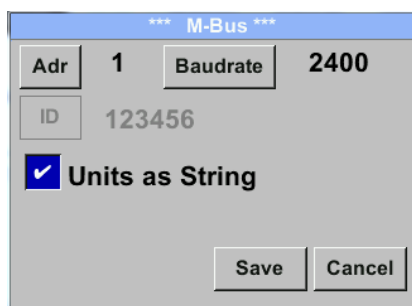

*** M-Bus ***

Adr 1 Baudrate 2400

ID 123456

Units as String

Save Cancel

The Sensor offers two possibilities for coding the Value Information Field (VIF).

- Primary VIF (The units and multiplier correspond to MBus specification 4.8 chapter 8.4.3)
- Plain Text VIF ((units are transmitted as ASCII characters. So units that are not included in MBus specification chapter 8.4.3 are possible)

Download:

<https://m-bus.com/assets/downloads/MBDOC48.PDF>

Switch to Plain Text VIF by activation of „Units as String“

8.4.3 Default Settings communication

Primary Address*:	1
ID:	Serial number of Sensor
Baud rate*:	2400
Medium*:	depending on medium (Gas or Compressed Air)
Manufacturer ID:	CSI
VIF coding:	Primary VIF

Both addresses, Primary address and ID, could be searched in the M-Bus system automatically.

8.4.4 Default values transmitted

Value 1 with [Unit]*:	Consumption [m ³]
Value 2 with [Unit]*:	Flow [m ³ /h]
Value 3 with [Unit]*:	Gas temperature [°C]

*All Values could be changed / preset in production or with CS Service software (Order-No. 0554 2007)



9 Supplementary Documentation

- Supplementary Documentation for Ex-Version:

Flow / Consumption Sensor VA 550 Ex / VA5 70 Ex - Ex-Documentation

KONFORMITÄTSERKLÄRUNG

DECLARATION OF CONFORMITY

Wir **CS Instruments GmbH & Co.KG**
 We **Zindelsteiner Straße 15, 78052 Villingen -Schwenningen**

Erklären in alleiniger Verantwortung, dass das Produkt
 Declare under our sole responsibility that the product

Verbrauchs-/ Durchflusssensor VA 570
 Flow Sensor VA570

den Anforderungen folgender Richtlinien entsprechen:
 We hereby declare that above mentioned components comply with requirements of the following EU directives :

Elektromagnetische Verträglichkeit Electromagnetic compatibility	2014/30/EU 2014/30/EC
RoHS (Restriction of certain Hazardous Substances)	2011/65/EC & 2015/863/EC

Angewandte harmonisierte Normen:
 Harmonised standards applied:

EMV-Anforderungen EMC requirements	EN 61326-1 EN 61326-1: 2013-07
---------------------------------------	-----------------------------------

Anbringungsjahr der CE Kennzeichnung: 15
 Year of first marking with CE Label: 15

Das Produkt ist mit dem abgebildeten Zeichen gekennzeichnet.
 The product is labelled with the indicated mark.



Villingen-Schwenningen, den 12.10.2021

 Wolfgang Blassing Geschäftsführer



