

Instruction manual

VA 521

**Compact inline flow sensor with
integrated flow straightener**

with Display, 4 ... 20 mA and pulse output (galv. isolated)



I. Foreword

Dear customer,

thank you very much for deciding in favour of the VA 521. Please read this installation and operation manual carefully before mounting and initiating the device and follow our advice. A riskless operation and a correct functioning of the VA 521 are only guaranteed in case of careful observation of the described instructions and notes

II. Table of Contents

I. Foreword	2
II. Table of Contents	3
1 Safety instructions	5
2 Instruments description	6
3 Technical data	8
4 Scaling Analogue output Compressed Air	9
5 Installation Description	10
5.1 Pipe/tube requirements	Fehler! Textmarke nicht definiert.
5.2 Inlet / outlet runs	Fehler! Textmarke nicht definiert.
5.3 Installation of VA 521	Fehler! Textmarke nicht definiert.
5.4 Displayhead Position	10
6 Flow measuring ranges	11
6.1 Flow for different gases	11
7 Dimensions	12
7.1 With measurement section and screw-in thread	12
7.2 With measurement section and flange (Material stainless steel 1.4404):	Fehler! Textmarke nicht definiert.
8 Electrical wiring	13
8.1 Pulse or MBus	13
8.2 Ethernet (optional PoE)	14

9	Operation	15
9.1	Initialization	16
9.2	Main menu	16
9.3	Settings	17
9.3.1	Sensor Setup	17
9.3.1.1	Input / change tube diameter	17
9.3.1.2	Input / change consumption counter	18
9.3.1.3	Definition of the units for flow, velocity, temperature and pressure	18
9.3.1.4	Definition of the reference conditions	19
9.3.1.5	Setting of Zeropoint and Low-flow cut off	21
9.3.2	Modbus RTU Setup	22
9.3.3	Modbus TCP (Optional)	23
9.3.3.1	Network Setup DHCP	23
9.3.3.2	Network Settings static IP	24
9.3.3.3	Modbus TCP Settings	25
9.3.3.4	Modbus Settings (2001...2005)	26
9.3.3.5	Values Register (1001 ... 1500)	26
9.3.4	Pulse /Alarm	28
9.3.4.1	Pulse output	28
9.3.5	User Setup	29
9.3.5.1	Password	29
9.3.5.2	Language	29
9.3.5.3	Display / Touch	30
9.3.6	Advanced	30
9.3.7	4 -20mA	31
9.3.8	VA 521 Info	33
9.4	MBus	34
9.4.1	Default Settings communication	34
9.4.2	Default values transmitted	34
10	Status / Error messages	35
10.1	Status messages	35
10.2	Error messages	36
11	Maintenance	37
12	Cleaning of the sensor head	37
13	Re-Calibration	37
14	Spare parts and repair	37
15	Calibration	37
16	Warranty	37

1 Safety instructions



Please read carefully before starting the device!

Warning: Do not exceed the pressure range of 16 bar!

Observe the measuring range of the sensor!

Always observe the direction of flow when positioning the sensor!

The screwed fixture must be pressure tight.

It is absolutely necessary to avoid condensation on the sensor element or water drops in the measuring air as they may cause faulty measuring results.

The manufacturer cannot be held liable for any damage which occurs as a result of non-observance or non-compliance with these instructions. Should the device be tampered with in any manner other than a procedure which is described and specified in the manual, the warranty is cancelled and the manufacturer is exempt from liability.

The device is destined exclusively for the described application.

We offer no guarantee for the suitability for any other purpose and are not liable for errors which may have slipped into this operation manual. We are also not liable for consequential damage resulting from the delivery, capability or use of this device.

We offer you to take back the instruments of the instruments family VA 521 which you would like to dispose of.

Qualified employees from the measurement and control technology branch should only carry out adjustments and calibrations.



The consumption sensor VA 521 works according to the calorimetric measuring procedure.

Flammable gases

If this consumption sensor is used for measurement of flammable gases (e. g. natural gas and so on) we expressly would like to point out that the sensor has no DVGW admission, however, it can be used for measurements in natural gas. A DVGW admission is not mandatory.

The consumption sensor corresponds with the current state of technology and basically it can be used in any flammable and non-flammable gases.

If the sensor is used e.g. in the medium natural gas, the sensor will be adjusted for natural gas. The calibration protocol (inspection certificate) will be included in the scope of delivery.

The area outside the pipeline (ambient area of the sensor) must not be an explosive area.

The installation has to be carried out by authorized professionals.

2 Instruments description

The newly developed VA 521 combines modern digital interfaces for connection to energy monitoring systems with a small, compact design. The VA 521 is always used when many machines (compressed air consumers) are to be connected/integrated to a energy monitoring network.

Special features:

- Compact, small design - for use in machines, behind the maintenance unit on the final consumers
- Screw-in thread for easy installation in existing pipelines due to integrated measuring block
 - Sizes : ¼", ½" ¾", 1" 1 ¼" , 1 ½" and 2"
- Integrated flow straighteners (no inlet runs necessary, except ¼")
- Integrated display with presentation of 2 values
 - Flow & Consumption,
 - Speed & Temperature
- Operation via integrated keyboard
 - Units selection
freely selectable. m³/h, m³/min, l/min, l/s, kg/h, kg/min, g/s, lb/min, lb/h
cfm, m/s,ft/min
- Digital interfaces
 - Modbus RTU (RS485)
 - Ethernet
 - MBus
- Analog interfaces
 - 4..20mA
 - Pulse output galv. insulated.
- Pressure measurement (optional)

Noze The optional CS Instruments Service Software enables you to:

- Selection/conversion of gas type (air, nitrogen, argon, nitrous oxide, CO₂, oxygen)
- Scaling Analog output 4..20mA
- Read out service data
- Sensor diagnosis

3 Intended use

The VA 521 consumption sensor is used for continuous flow measurements.

The VA 525 consumption sensor is designed and constructed exclusively for the intended purpose described here and may only be used accordingly.

The user must check whether the instrument is suitable for the selected application. It must be ensured that the medium is compatible with the wetted parts. The technical data listed in the data sheet are binding.

Improper handling or operation outside the technical specifications is not permitted. Claims of any kind based on improper use are excluded.

Operating principle:

The VA 521 consumption probe operates according to the calorimetric measuring method.

The basis of this measuring method is the electrical heating of the mechanically protected built-in sensor. The mass flow, the volume flow and the flow velocity can be measured and determined by the resulting heat flow to the passing medium (gas).

With the calorimetric measurement method (based on the measurement principle), the operating temperature and pressure of the medium have no influence on the measurement result, only the material data of the gas component are decisive.

4 Technical data

Measurement:	Flow and consumption
Reference Standard:	Standard settings ex works: DIN 1945, ISO 1217 at 20°C and 1000 mbar
Selectable Units	m³/h (Standard settings ex works) m ³ /min, l/min, l/s, ft/min, cfm, m/s, kg/h, kg/min, kg/s
Measuring principle:	calorimetric measurement
Sensor:	Pt45, Pt1000
Measuring medium:	Air, gases
Operating temperature:	-30 ... 80°C probe tube -20 ... 70°C housing
Operating pressure:	up to 16 bar, special version PN 40 (40 bar)
Power supply:	12 to 36 VDC
Power consumption:	max. 5W
Digital output:	RS 485 (Modbus RTU)
Analog output:	4...20 mA (see chapter 4), max. burden < 500 Ohm
Pulse output:	pulse output potential free (dry contact) passive: max. 48Vdc, 150mA 1 pulse pro m ³ resp. pro l, Valency adjustable with the display keys
Accuracy:	± 1,5 % m.v., ± 0,3 % f. s.*
Display:	TFT 1.8 Resolution 220 x 176
Mounting thread: measuring block	G 1/4", G 1/2", G 3/4", G 1", G 1 1/4" G 1 1/2", G 2"
Material measuring block:	Aluminium
Protection class:	IP65

* m.v. = measured values
f.s. = full scale

5 Scaling Analogue output Compressed Air

Reference DIN1945/ ISO 1217: 20°C, 1000 mbar (Reference during calibration)

Description	Version	Analogue output	
VA 521 with integrated ½" measuring block	Low Speed	4... 20 mA =	0...20 m³/h
	Standard		0...45 m³/h
	Max		0...90 m³/h
	High Speed		0...110 m³/h
VA 521 with integrated ¾" measuring block	Low Speed	4... 20 mA =	0...45 m³/h
	Standard		0...85 m³/h
	Max		0...175 m³/h
	High Speed		0...215 m³/h
VA 521 with integrated 1" measuring block	Low Speed	4... 20 mA =	0...75 m³/h
	Standard		0...145 m³/h
	Max		0...290 m³/h
	High Speed		0...355 m³/h
VA 521 with integrated 1¼" measuring block	Low Speed	4... 20 mA =	0...140 m³/h
	Standard		0...265 m³/h
	Max		0...530 m³/h
	High Speed		0...640 m³/h
VA 521 with integrated 1½" measuring block	Low Speed	4... 20 mA =	0...195 m³/h
	Standard		0...365 m³/h
	Max		0...730 m³/h
	High Speed		0...885 m³/h
VA 521 with integrated 2" measuring block	Low Speed	4... 20 mA =	0...320 m³/h
	Standard		0...600 m³/h
	Max		0...1195m³/h
	High Speed		0...1450 m³/h

6 Installation Description

6.1 Installation of VA 521

The sensor VA 521 is pre-supplied with the measuring block.



- An installation at customer site is only allowed in the unpressurized state of the system.
- Tightness of the connection must be checked and ensured
- The connecting nut is tightened to a torque of 25 -30 Nm.
- It has to be checked whether the VA 521 is correctly installed in the measuring section, the flow direction arrows must point from the integrated flow straightener away.

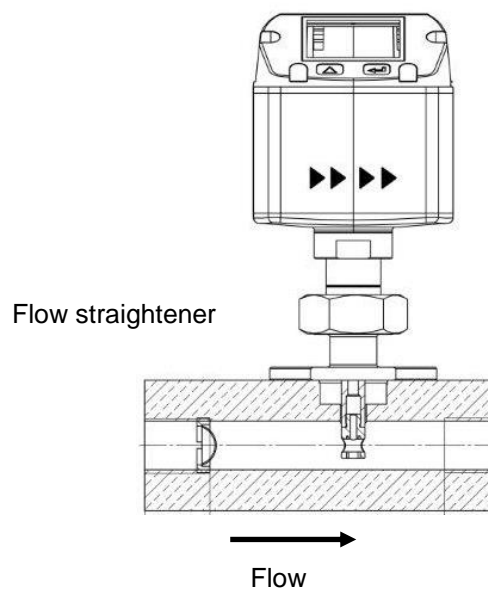

6.2 Display head Position

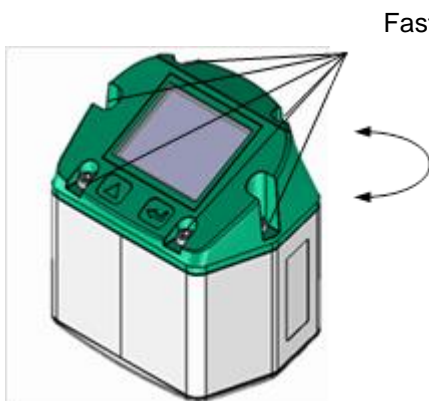

The Position of the Display head is twistable by 180 e.g. in case of reverse flow direction. For this purpose the 6 fastening screws are to be released and the display head rotated 180°.

Caution:

It must be ensured that the connection plugs are still plugged and the gasket is installed correctly.

7 Flow measuring ranges

7.1 Flow for different gases

	1/2"	3/4"	1"	1 1/4"	1 1/2"	2"
	Analog output 20mA	Analog output 20mA	Analog output 20mA	Analog output 20mA	Analog output 20mA	Analog output 20mA
	[m ³ /h]	[m ³ /h]	[m ³ /h]	[m ³ /h]	[m ³ /h]	[m ³ /h]

Reference DIN1945/ ISO 1217: 20°C, 1000 mbar (Reference during calibration)

Air	Low Speed	20	45	75	140	195	320
	Standard	45	85	145	265	365	600
	Max	90	175	290	530	730	1195
	High Speed	110	215	355	640	885	1450

Adjustment to DIN 1343: 0°C, 1013,25 mbar

Air	Low Speed	20	40	70	130	180	295
	Standard	40	80	135	240	335	550
	Max	80	160	270	485	670	1100
	High Speed	100	195	325	590	815	1330
Argon (Ar)	Low Speed	35	75	120	220	305	505
	Standard	70	135	230	415	570	935
	Max	140	275	460	830	1140	1870
	High Speed	170	335	555	1005	1385	2265
Carbon dioxide (CO ₂)	Low Speed	20	45	75	140	195	320
	Standard	45	85	145	260	360	590
	Max	90	175	290	525	720	1185
	High Speed	105	210	350	635	875	1430
Nitrogen (N ₂)	Low Speed	20	40	70	130	180	295
	Standard	40	80	135	240	335	550
	Max	80	160	270	485	670	1100
	High Speed	100	195	325	590	815	1330
Oxygen f (O ₂)	Low Speed	20	45	75	135	185	305
	Standard	40	80	140	250	345	570
	Max	85	165	280	505	695	1140
	High Speed	105	205	340	610	845	1380
Nitrous oxide (N ₂ O)	Low Speed	20	45	75	140	190	315
	Standard	40	85	140	260	355	585
	Max	85	170	285	520	715	1170
	High Speed	105	210	345	630	865	1420

Other gases on request

Please note:

The area outside the pipeline (ambient area of the sensor) must not be an explosive area.

8 Dimensions

8.1 With measurement section and screw-in thread

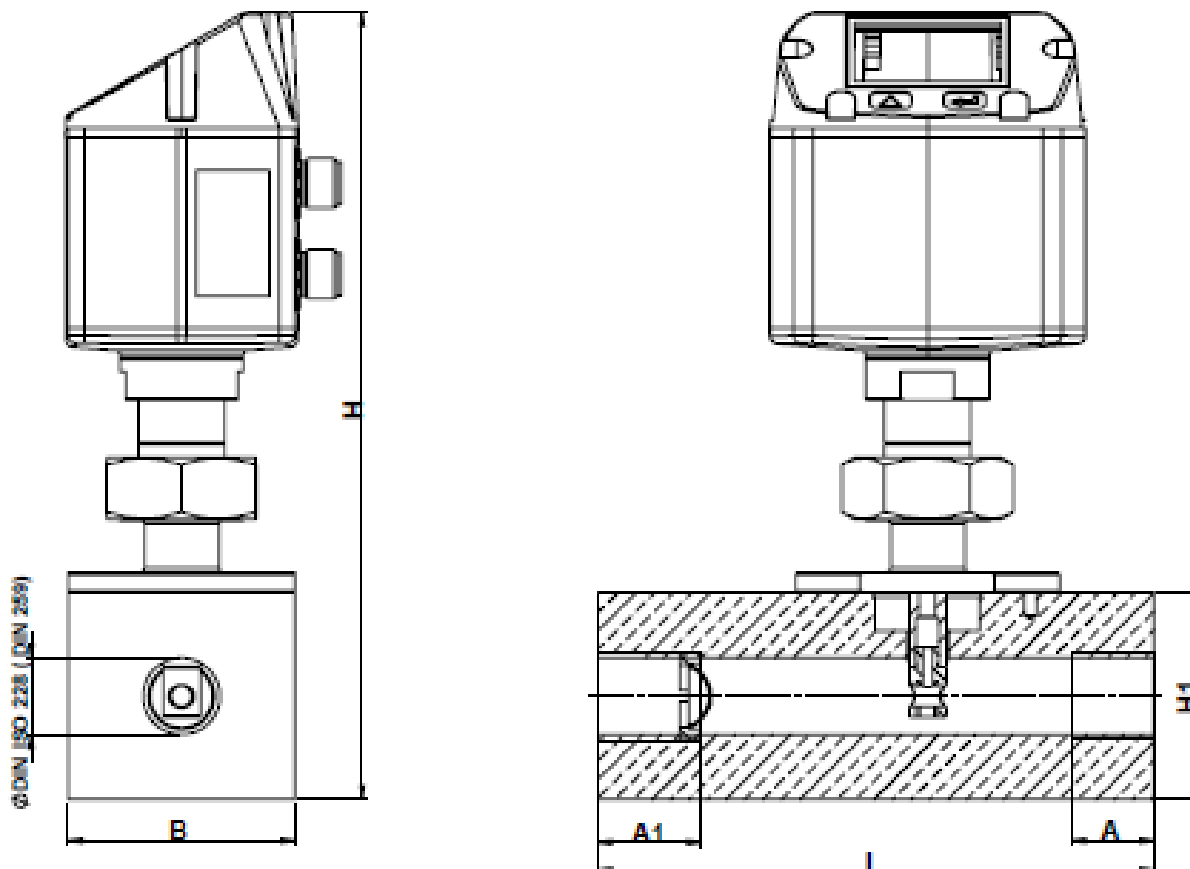

	Pipe size	Thread	L (mm)	B (mm)	H (mm)	H1 (mm)	A1 (mm)	A (mm)
VA 521 1/2"	DN 15	G1/2"	135	55	190,65	50	25	20
VA 521 3/4"	DN 20	G3/4"	135	55	190,65	50	26	20
VA 521 1"	DN 25	G1"	135	55	190,65	50	33	25
VA 521 1 1/4"	DN 32	G1 1/4"	135	80	215,45	80	35	25
VA 521 1 1/2"	DN 40	G 1 1/2"	135	80	215,45	80	36	25
VA 521 2"	DN 50	G2"	135	80	215,45	80	44	30

9 Electrical wiring

9.1 Modbus RTU, 4...20mA, Pulse or MBus

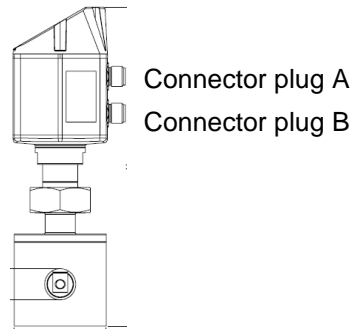

Attention: Not required connections NC must not be connected to a voltage and/or to protection earth. Cut and insulate cables.

	Pin 1	Pin 2	Pin 3	Pin 4	Pin 5
Connector plug A	+VB	RS 485 (A)	-VB	RS 485 (B)	I+ 4..20 mA
Connector plug B Pulse output (standard)	NC	GND	DIR	Pulse galv. isolated	Pulse galv. isolated
Connector plug B Option MBus	NC	GND	DIR	MBus	MBus
Colours pulse cables 0553 0106 (5 m) 0553.0107 (10 m)	brown	white	blue	black	grey

Legend:

-VB	Negative supply voltage 0 V	Pulse	Pulse for consumption
+VB	Positive supply voltage 18...36 VDC smoothed	NC	Must not be connected to a voltage and/or to protection earth. Please cut and isolate cables.
I +	Current signal 4...20 mA – selected measured signal	MBus	MBus (reverse polarity protected)
RS 485 (A) RS 485 (B)	Modbus RTU A Modbus RTU A		

If no connection cable/ pulse cable is ordered the sensor will be supplied with a M12 connector plug. The user can connect the supply and signal cables as indicated in the connection diagram.

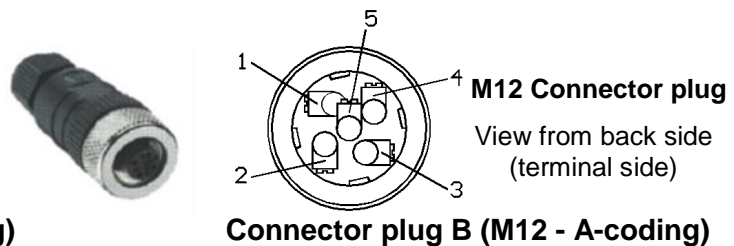

Connector plug A (M12 - A-coding)

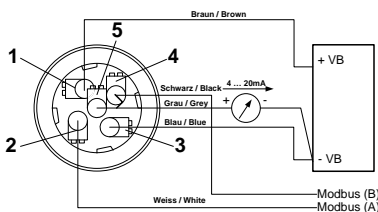

Connector plug B (M12 - A-coding)

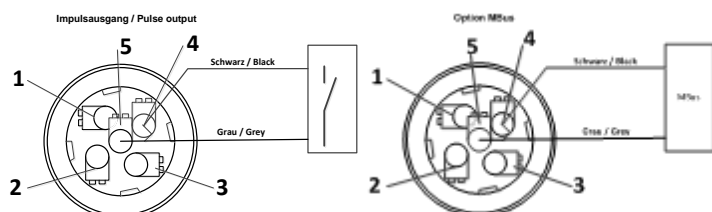

Remark: If the sensor is placed at the end of the Modbus system a termination is required. The sensors have an internal switchable termination, therefore the 6 fastening screws from the lid are to be released and set the internal DIP Switch to "On". It must be ensured that the connection plugs are still plugged and the gasket is installed correctly, see also chapter 6.2.

Alternatively, a 120R resistor can be installed in the plug between pin 2 and pin 4.

9.2 Ethernet (optional PoE)

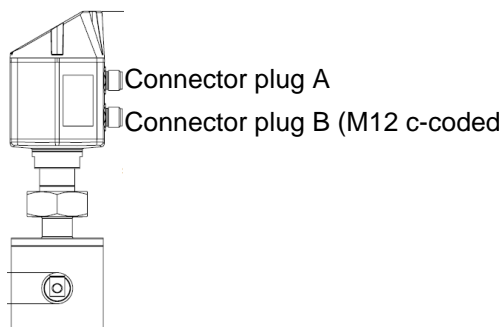

Connector plug B

M12 x-coded 8 pole

Data LINES: 1,2 und 3,4

PoE LINES: 5,6 und 7,8

Connection cable

M12 x-coded to RJ45

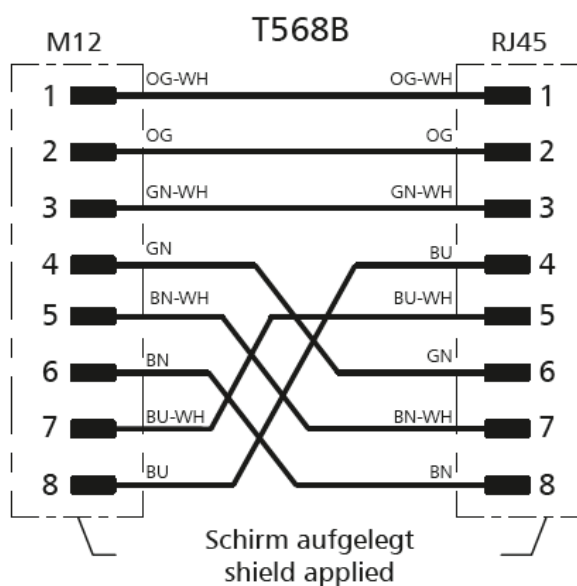
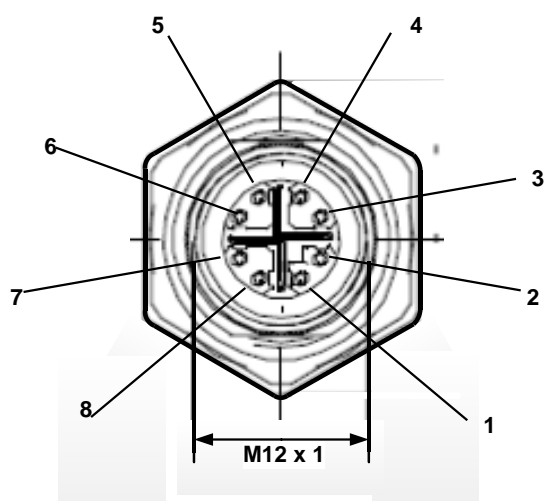

Connection cable: Cat 6.

Remark:

VA521 Power Classification acc. IEEE 802.3af: Class 2 (3,84W – 6,49W)

*PoE: Power over Ethernet

10 Operation

Remark: Only for version with display

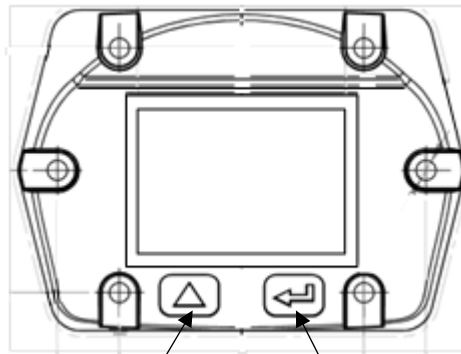

“Up“ (\triangle)

“OK“ (\rightarrow)

The operation of the VA 521 is done by the two capacitive key buttons Up (\triangle) and Enter (\rightarrow)

10.1 Initialization

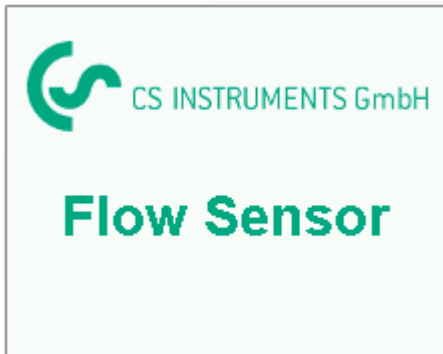

After switching on the VA 521, the initialized screen is displayed followed by the main menu.

10.2 Main menu

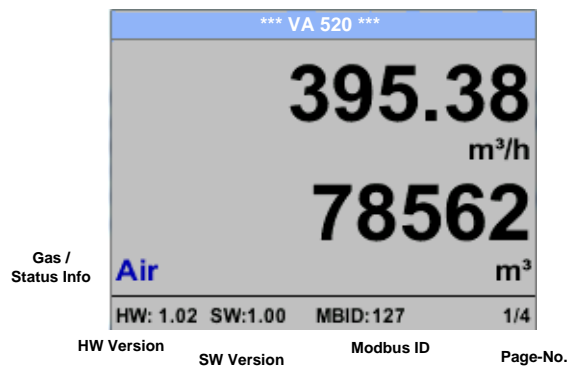

Switching to pages 2-4 or back by pressing key „△“

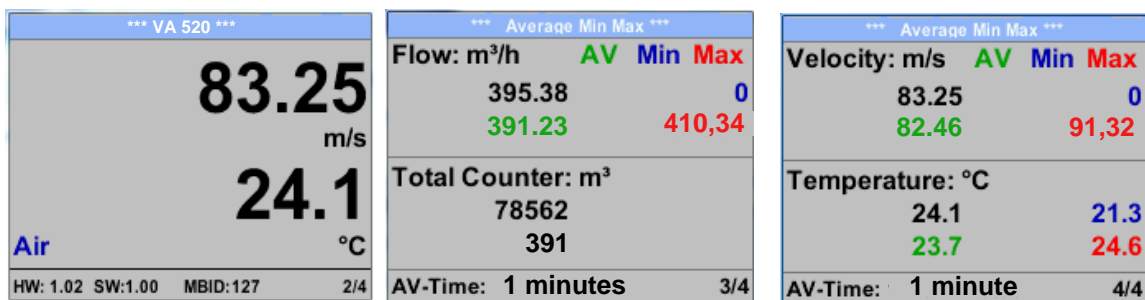

AV-Time (Period for average value calculation) could be changed under *Sensor Setup.-Advanced- AV-Time*

10.3 Settings

The settings menu could accessed by pressing the key „OK“.
But the access to the *settings menu* is password protected.



Factory settings for password at the time of delivery: 0000 (4 times zero).

If required the password could be changed at *Setup–User setup–Password.*

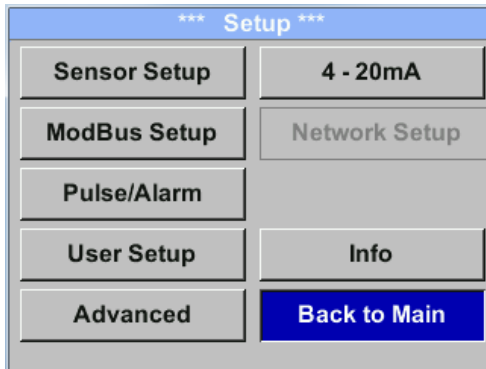

Selection of a menu item or to change a value is done with the key „ Δ “, a final move to the chosen menu item or takeover of the value change needs the confirmation by pressing the key „OK“

10.3.1 Sensor Setup

Setup → Sensor Setup

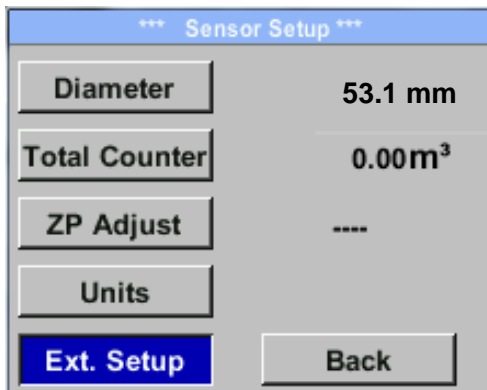

For changes, first select the menu item with key „ Δ “ **and** then confirm it with “OK”.

10.3.1.1 Input / change tube diameter

For VA 521 not adjustable (suspended) as voted on included measuring section with corresponding pipe diameter.

10.3.1.2 Input / change consumption counter

Setup → Sensor Setup → Total Counter → Unit button

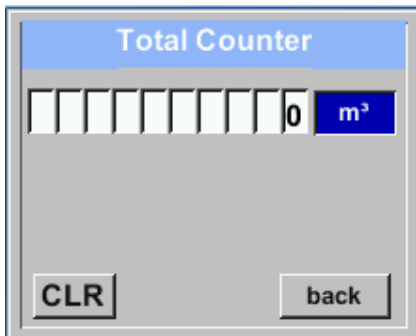
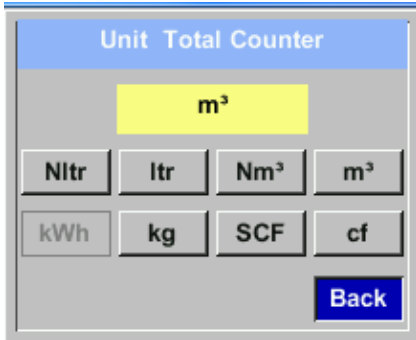

In order to change, e.g. the unit, first select by pressing key „Δ“ the button **“Unit”** and then key **“OK”**.

Select with the key „Δ“ the correct unit and then confirm selection by pressing 2x **„OK”**.

Entering / changing the consumption counter via button „Δ“, select the respective position and activate the position with the **“OK”** button.

By pressing „Δ“ the position value is incremented by 1. Complete with **“OK”** and activate next number position.

Confirm entry by pressing **„OK”**.

Important!

When the counter reach 100000000 m³ the counter will be reset to zero.

10.3.1.3 Definition of the units for flow, velocity, temperature and pressure

Setup → Sensor Setup → Units

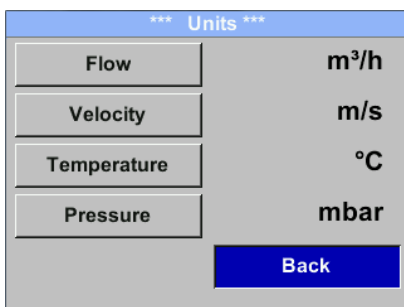

To make changes to the unit for the respective measurement value, first select by pressing „Δ“ the field of the „measurement value“ and activate „it with **„OK”** .

Selection of the new unit with **„Δ”**

In case the quantity of units selectable are not presentable on one page, pleas move to next page by pressing **„<<”** .

Confirm selection by pressing 2x **„OK”**.

Procedure for all 4 measurement variables is analogous.

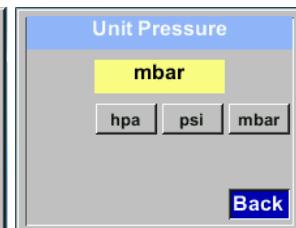
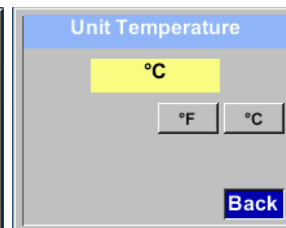
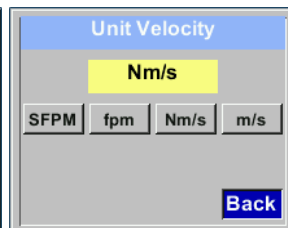
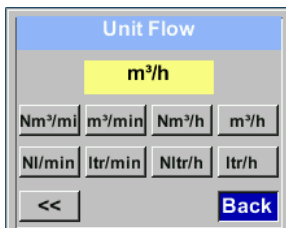

10.3.1.4 Definition of the reference conditions

Here can be defined the desired measured media reference conditions for pressure and temperature and times for the filter and averaging.

- Factory pre-setting for reference temperature and reference pressure are 20 °C, 1000 hPa
- All volume flow values (m³/h) and consumption values indicated in the display are related to 20 °C and 1000 hPa (according to ISO 1217 intake condition)
- Alternatively 0 °C and 1013 hPa (=standard cubic meter) can also be entered as a reference.
- **Do not enter the operation pressure or the operation temperature under reference conditions!**

Setup → Sensor Setup → Advanced

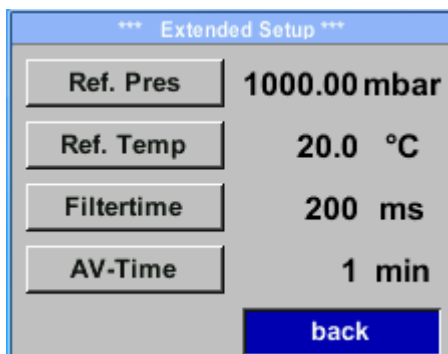

To make changes, first select a menu with button „△“ and confirm selection by pressing „OK“ .

Setup → Sensor Setup → Advanced → Ref.Pref

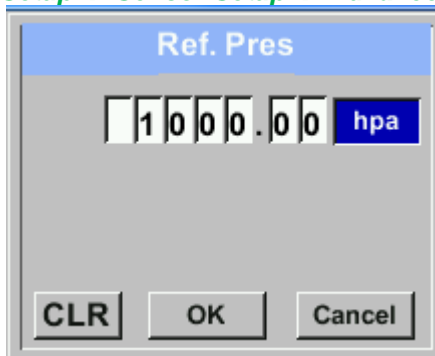

In order to change, e.g. the unit, first select by pressing key „△“ the field **“Units”** and then key **“OK”**.

Select with the key „△“ the correct unit and then confirm selection by pressing 2x **„OK”**.

Input / change of the value by selecting the respective position with button „△“ and entering by pressing button **„OK”** .

Setup → Sensor Setup → Advanced → Ref.Temp

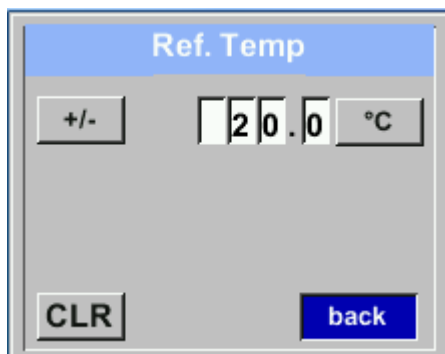

By pressing „△“ the position value is incremented by 1. Complete with **“OK”** and activate next number position.

Procedure for changing the reference temperature is the same.

Setup → Sensor Setup → Advanced → Filtertime

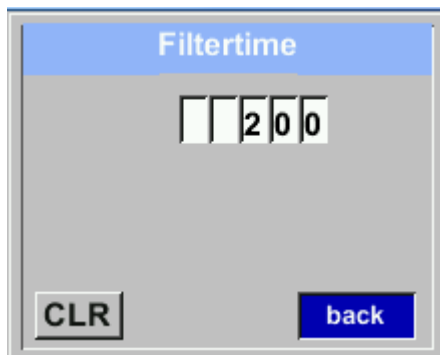

Under item **"Filtertime"** an attenuation can be defined.
Input values of 0 -10000 in [ms] are possible

Setup → Sensor Setup → Advanced → AV-Time

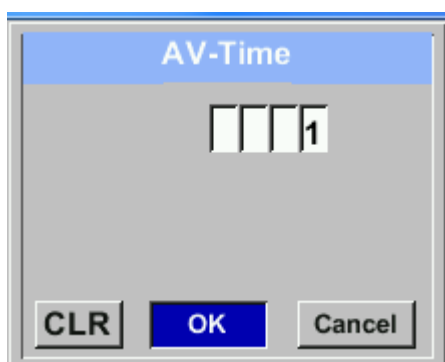

The time period for averaging can be entered here.
Input values of -1440 1 [minutes] are possible.
For average values see display window 3 + 4

10.3.1.5 Setting of Zero point and Low-flow cut off

Setup → Sensor Setup → ZP Adjust

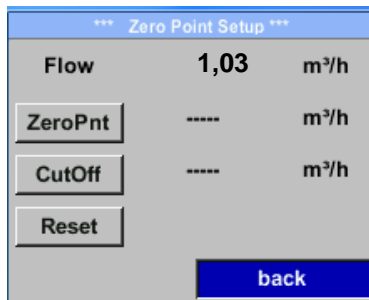

To make changes, first select a menu with button „ Δ “ and confirm selection by pressing „OK“.

Setup → Sensor Setup → ZP Adjust → ZeroPnt

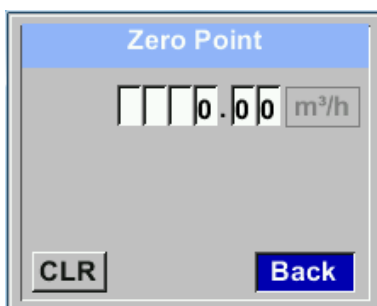

When, without flow, the installed sensor shows already a flow value of > 0 m³/h herewith the zero point of the characteristic could be reset.

For an input / change of the value select with the button „ Δ “ the respective number position and activate it with „OK“.

By pressing „ Δ “ the position value is incremented by 1. Confirm the input with „OK“ and activate next number position.

Leave menu with button „Back“

Setup → Sensor Setup → ZP Adjust → CutOff

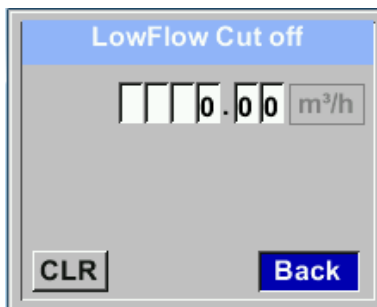

With the low-flow cut off activated, the flow below the defined "LowFlow Cut off" value will be displayed as 0 m³/h and not added to the consumption counter.

For an input / change of the value select with the button „ Δ “ the respective number position and activate it with „OK“.

By pressing „ Δ “ the position value is incremented by 1. Confirm the input with „OK“ and activate next number position.

Leave menu with button „Back“

Setup → Sensor Setup → ZP Adjust t → Reset

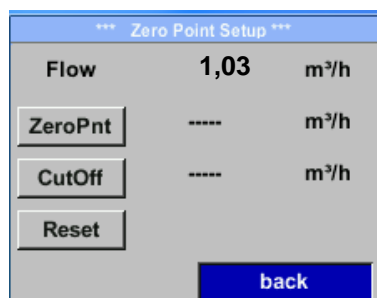

By selection of „Reset“ all settings for „ZeroPnt“ and „CutOff“ are reset.

Menu item to be select with button „ Δ “ and confirm the reset with „OK“.

Leave menu with button „Back“

10.3.2 Modbus settings

10.3.2.1 Modbus RTU Setup

The Flow sensors VA 521 comes with a Modbus RTU Interface. Before commissioning the sensor the communication parameters

- Modbus ID, Baudrate, Parity und Stop bit

must be set in order to ensure the communication with the Modbus master.

Settings → Modbus Setup

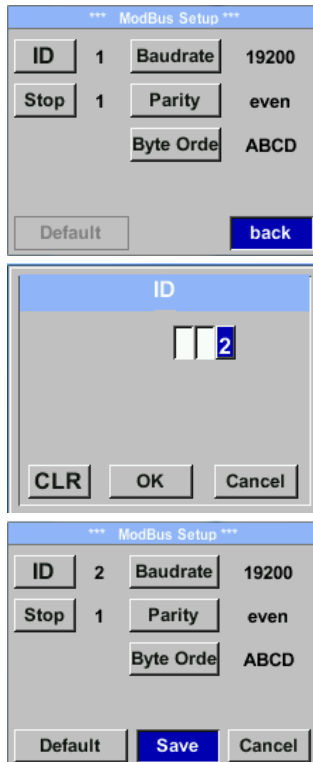

For changes, e.g. the sensor ID, first select by pressing key „△“ the field “ID” and then key “OK”.

Select the desired position by pressing the “>” and select with “OK” button.

Change values by pressing the „△“ values takeover by pressing “OK”.

Inputs for baud rate, stop bit and parity is done analogue.

By means of the button "Byte Order" it is possible to change the data format (Word Order). Possible formats are "ABCD" (Little Endian) and "CDAB" (Middle Endian)

Saving the changes by pressing “Save”, therefore select it with key „△“ and then confirm it with “OK”.

Default values out of factory: Modbus ID: 1
 Baud rate: 19200
 Stop bit: 1
 Parity: even
 Byte Order: ABCD

Remark: If the sensor is placed at the end of the Modbus system a termination is required. The sensors have an internal switchable termination, therefore the 6 fastening screws from the lid are to be released and set the internal DIP Switch to “On”.

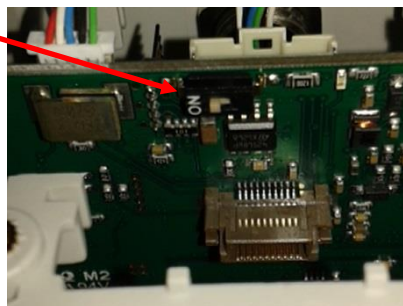
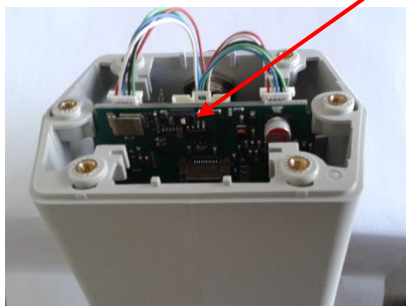

Alternatively, a 120R resistor can be installed in the plug between pin 2 and pin 4.

It must be ensured that the connection plugs are still plugged and the gasket is installed correctly, see also chapter 4.5.

10.3.2.2 Modbus TCP (Optional)

The Flow sensors VA 521 comes optional with a Modbus TCP Interface (HW Interface: M12 x 1 X-coded connector).

Device supports with this option the Modbus TCP protocol for communication with SCADA systems. TCP port is set to 502 by default. Port can be changed at the sensor or using PC Service Software

Modbus device address (Unit Identifier) can be set in the range of 1- 255. Specification and description of the Modbus protocol is free to download on: www.modbus.org.

Supported Modbus commands (functions):

Command	Code	Description
Function Code	3	(Read holding register)
Function code	16	(Write multiple registers)

For more details, please see **VA 5xx Modbus RTU_TCP Installation V1.04**

Settings → Network Setup

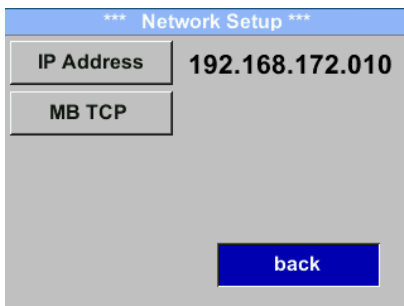

10.3.2.2.1 Network Setup DHCP

Settings → Network Setup Settings → IP Address

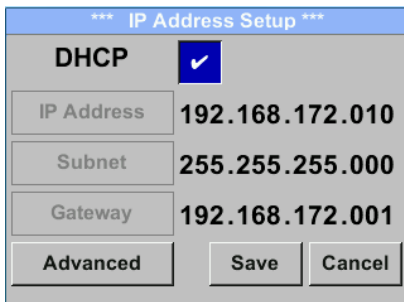

Here you can set up and made a connection, with or without *DHCP*, to a computer.

Remark:
With activated *DHCP* the automatic integration of the sensor in an existing network is possible, without a manual configuration.

Storing of settings by pressing “*Save*”

10.3.2.2.2 Network Settings static IP

Settings → Network Setup Settings → IP Address → IP Address

Settings → Network Setup Settings → IP Address → Sub Net

Settings → Network Setup Settings → IP Address → Gateway

*** IP Address Setup ***

DHCP

IP Address 192.168.172.010

Subnet 255.255.255.000

Gateway 192.168.172.001

Advanced back

*** IP Address Setup ***

DHCP

IP Address 192.168.172.010

Subnet 255.255.255.000

Gateway 192.168.172.001

Advanced back

IP Setup

1 9 2

CLR back

For manual (static) IP, the "IP Address", "Subnet" and "Gateway" selection keys must be selected and activated with "OK".

The first data field of the selection, in this case the IP address, is then marked (red).

Confirm with "OK" the corresponding input menu is opened.

By means of ">", the next data field is changed.

Select the desired position with the ">" key and activate it with the "OK" key.

Change the values with the ">" key, and accept the values with the "OK" key.

Procedure for "Subnet" and "Gateway" is analogous.

Subnet Setup

2 5 5

CLR back

Gateway Setup

1 9 2

CLR back

*** IP Address Setup ***

DHCP

IP Address 192.168.172.011

Subnet 255.255.255.000

Gateway 192.168.172.001

Advanced Save Cancel

Store the settings by „Save“

10.3.2.3 Modbus TCP Settings

Settings → Network Setup Settings → IP Address → MB TCP

Settings → Network Setup Settings → IP Address → ID

Settings → Network Setup Settings → IP Address → Port

For changes, e.g. the sensor ID, first select by pressing key „>“ the field “ID” and then key “OK”.

Select the desired position by pressing the “>” and select with “OK” button.

Change values by pressing the „>“ values takeover by pressing “OK”.

Input for the port is done analogue.

By means of the button “Byte Format” it is possible to change the data format (Word Order). Possible formats are “ABCD” (Little Endian) and “CDAB” (Middle Endian)

Saving the changes by pressing “Save”, therefore select it with key „>“ and then confirm it with “OK”.

Reset to the default settings by activating “Set to Default”-

10.3.2.4 Modbus Settings (2001...2005)

Modbus Register	Register Address	No. of Byte	Data Type	Description	Default Setting	Read Write	Unit /Comment
2001	2000	2	UInt16	Modbus ID	1	R/W	Modbus ID 1...247
2002	2001	2	UInt16	Baud rate	4	R/W	0 = 1200 1 = 2400 2 = 4800 3 = 9600 4 = 19200 5 = 38400
2003	2002	2	UInt16	Parity	1	R/W	0 = none 1 = even 2 = odd
2004	2003	2	UInt16	Number of Stop bits		R/W	0 = 1 Stop Bit 1 = 2 Stop Bit
2005	2004	2	UInt16	Word Order	0xABCD	R/W	0xABCD = Big Endian 0xCDAB = Middle Endian

10.3.2.5 Values Register (1001 ...1500)

Modbus Register	Register Address	No. of Byte	Data Type	Description	Default	Read Write	Unit /Comment
1101	1100	4	Float	Flow in m ³ /h		R	
1109	1108	4	Float	Flow in Nm ³ /h		R	
1117	1116	4	Float	Flow in m ³ /min		R	
1125	1124	4	Float	Flow in Nm ³ /min		R	
1133	1132	4	Float	Flow in ltr/h		R	
1141	1140	4	Float	Flow in Nltr/h		R	
1149	1148	4	Float	Flow in ltr/min		R	
1157	1156	4	Float	Flow in Nltr/min		R	
1165	1164	4	Float	Flow in ltr/s		R	
1173	1172	4	Float	Flow in Nltr/s		R	
1181	1180	4	Float	Flow in cfm		R	
1189	1188	4	Float	Flow in Ncfm		R	
1197	1196	4	Float	Flow in kg/h		R	
1205	1204	4	Float	Flow in kg/min		R	
1213	1212	4	Float	Flow in kg/s		R	
1221	1220	4	Float	Flow in kW		R	

Modbus Register	Register Address	No.of Byte	Data Type	Description	Default	Read Write	Unit /Comment
1269	1268	4	UInt32	Consumption m ³ before comma	x	R	
1275	1274	4	UInt32	Consumption Nm ³ before comma	x	R	
1281	1280	4	UInt32	Consumption ltr before comma	x	R	
1287	1286	4	UInt32	Consumption Nltr before comma	x	R	
1293	1292	4	UInt32	Consumption cf before comma	x	R	
1299	1298	4	UInt32	Consumption Ncf before comma	x	R	
1305	1304	4	UInt32	Consumption kg before comma	x	R	
1311	1310	4	UInt32	Consumption kWh before comma	x	R	
1347	1346	4	Float	Velocity m/s			
1355	1354	4	Float	Velocity Nm/s			
1363	1362	4	Float	Velocity Ft/min			
1371	1370	4	Float	Velocity NFt/min			
1419	1418	4	Float	GasTemp °C			
1427	1426	4	Float	GasTemp °F			

Remark:

- **For DS400 / DS 500 / Handheld devices - Modbus Sensor Datatype**
„Data Type R4-32“ match with „Data Type Float“
- For more additional Modbus values please refer to
VA5xx_Modbus_RTU_Slave_Installation_1.04_EN.doc

10.3.3 Pulse /Alarm

Setup → Sensor Setup → Pulse/ Alarm

Relay Mode:	Alarm
Unit	°C
Value	20.0
Hyst.	5.0
Hi-Lim.	OK Cancel

*** Pulse / Alarm ***	
Relay Mode:	Alarm
Unit:	°C
Value	20.0
Hyst.	5.0
Hi-Lim.	OK Cancel

*** Pulse / Alarm ***	
Relay Mode:	Pulse
Unit:	m ³
Value	0.1
Polarity	pos.
Pls per second at max Speed: 0 Back	

The galvanically isolated output can be defined as pulse- or alarm output. Selection of field „**Relay Mode**” with key „**Δ**” and change modus by pressing key „**OK**”.

For alarm output following units could be chosen: kg/min, cfm, ltr/s, m³/h, m/s, °F, °C and kg/s.

„**Value**” defines the Alarm value, „**Hyst.**” defines the desired hysteresis and with „**Hi-Lim**” or „**Lo-Lim**” the alarm settings when the alarm is activated
 Hi-Lim: Value over limit
 Lo-Lim: Value under limit

For the pulse output following units could be chosen: kg, cf, ltr and m³. The pulse value definition to be done in menu „**Value**”. Lowest value is depending on max. flow of sensor and the max frequency of pulse output of 50Hz.

With „**Polarity**” the switching state could be defined. Pos. = 0 → 1 neg. 1 → 0

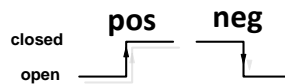

10.3.3.1 Pulse output

The maximum frequency for pulse output is 50 pulses per second (50Hz). The Pulse output is delayed by 1 second.

Pulse value	[m ³ /h]	[m ³ /min]	[l/min]
0.1 ltr / Pulse	18	0,3	300
1ltr / Pulse	180	3	3000
0.1m ³ / Pulse	18000	300	300000
1 m ³ / Pulse	180000	3000	3000000

Table 1 Maximum flow for pulse output

Entering pulse values that are not allow a presentation to the full scale value, are not allowed. Entries are discarded and error message displayed.

10.3.4 User Setup

10.3.4.1 Password

Settings → UserSetup → Password

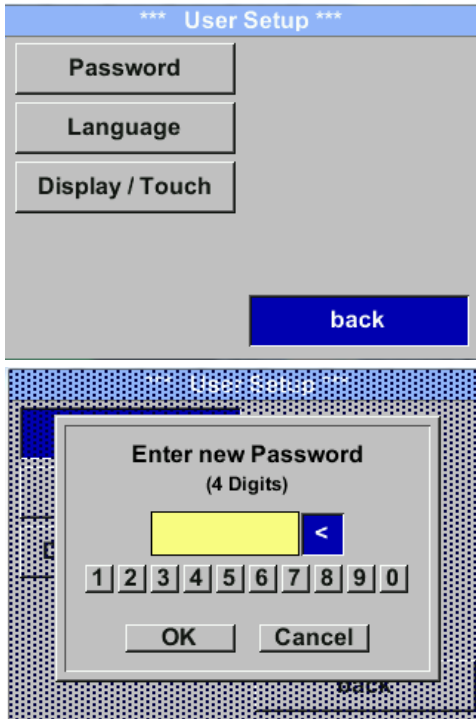

To make changes, first select a menu with button „ Δ “ and confirm selection by pressing „OK“.

It is possible to define a password. The required password length is 4 digits. Please select with button „ Δ “ a figure and confirm it with „OK“. Repeat this 4 times.

With „ Δ “ the last figure could be deleted. Password input have to be inserted twice.

Confirmation of input/password by pressing „OK“.

Factory settings for password at the time of delivery: 0000 (4 times zero).

10.3.4.2 Language

Settings → UserSetup → Language

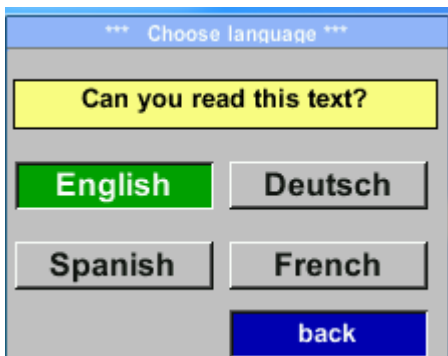

Currently 4 languages have been implemented and could be selected with button „ Δ “

Change of language by confirming with “OK”. Leaving the menu with button “back”.

10.3.4.3 Display / Touch

Settings → UserSetup → Display / Touch

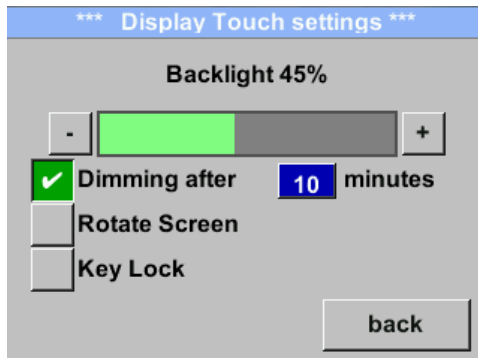

With the button „-“ and with button „+“ it is possible to adjust the backlight / display brightness. The actual / adjusted backlight brightness is showed in the graph „**Backlight.**“

By activation **“Dimming after”** and entering a time a display dimming could be set.

With **„Rotate Screen“** the display information could be rotated by 180°.

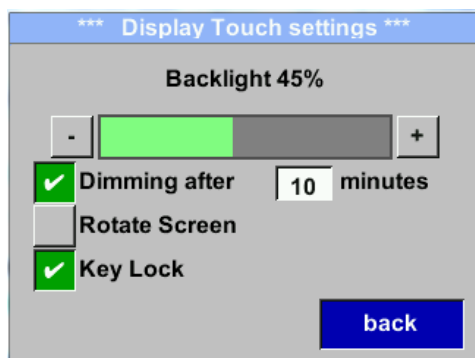

By activation of **„Key Lock“** the operation of the sensor locked.

Unlocking the keyboard is only possible by restarting the sensor and calling the operating menu within the first 10s. To do this, use the **“OK”** button to enter the operating menu during this period

10.3.5 Advanced

Settings → Advanced

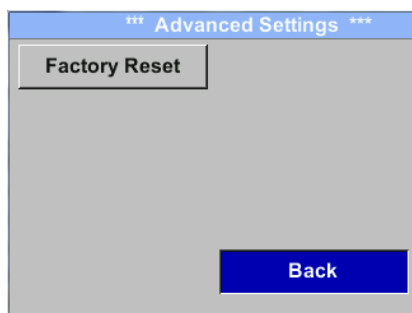

By pressing **„Factory Reset“** the sensor is set back to the factory settings.

10.3.6 4 -20mA

Settings → 4-20mA

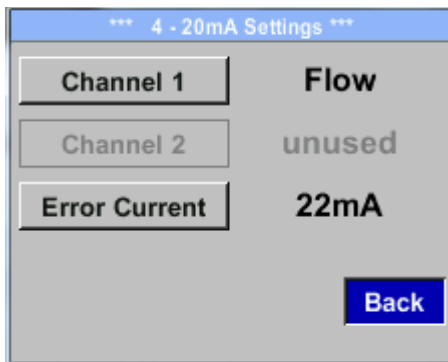

To make changes, first select a menu with button „ Δ “ and confirm selection by pressing „OK“.

Settings → 4-20mA → Channel 1

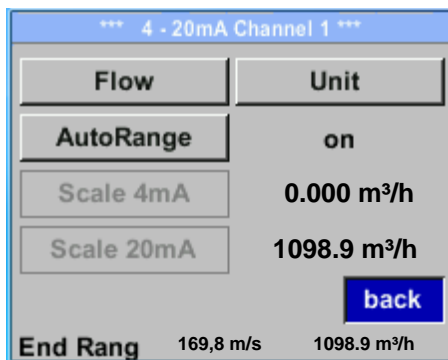

The 4-20 mA Analogue output of the Sensor VA 521 can be individually adjusted.

It is possible to assign following values „Temperature“, „Velocity“ und „Flow“ to the channel CH 1.

To make changes, first select the value item with button „ Δ “ .and confirm
Moving between the different measurements values or to deactivate the 4-20mA with setting to „unused“ by pressing „OK“.

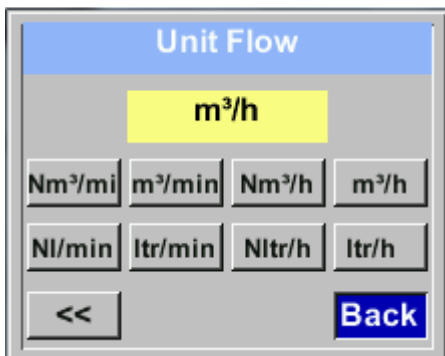

To the selected measurement value a corresponding / appropriate unit needs to be defined. Select „Unit“ with „ Δ “ and open menu with „OK“. Select required unit with „ Δ “ and take over by pressing „OK“.

Here e.g. for the measurement value Flow, procedure for the other measurements values is analog.

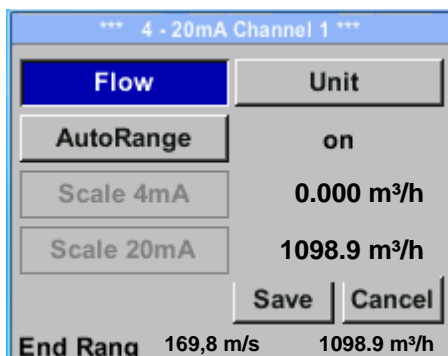

For saving the changes done press button „Save“ to discard the changes press button „Cancel“.

Leaving the menu with „Back“.

Settings → 4-20mA → Channel 1 → AutoRange

Flow	Unit
AutoRange	off
Scale 4mA	0.000m³/h
Scale 20mA	1098,9 m³/h
<input type="button" value="Save"/> <input type="button" value="Cancel"/>	
End Range	169,8m/s 1098,9 m³/h

4mA Scale Low	
0.00	m³/h
<input type="button" value="CLR"/>	<input type="button" value="Back"/>

20mA Scale High	
0.00	m³/h
<input type="button" value="CLR"/>	<input type="button" value="Back"/>

The scaling of the 4-20mA channel can be done automatically "Auto Range = on" or manual "AutoRange = off" .

With button „**△**“ select the menu item „AutoRange“ select with „**OK**“ the desired scaling method. (Automatically or manually)

In case of **AutoRange = off** with „**Scale 4mA**“ und „**Scale 20mA**“ the scale ranges needs to be defined.

Select with button „**△**“ the item „Scale 4mA“ or „Scale 20mA“ and confirm with „**OK**“ .

Input of the scaling values will be analogous as described before for value settings.

Using „**CLR**“ clears up the complete settings at once.

For „**Auto on**“ , the max. scaling is calculated based on the inner tube diameter, max. measurement range and the reference conditions settings.

Takeover of the inputs with „**Save**“ and leaving the menu with „**Back**“.

Settings → 4-20mA → Error Current

*** 4 - 20mA Settings ***	
<input type="button" value="Channel 1"/>	Flow
<input type="button" value="Channel 2"/>	unused
<input type="button" value="Error Current"/>	22mA
<input type="button" value="Back"/>	

This determines the output in case of an error at the analog output.

- 2 mA Sensor error / System error
- 22 mA Sensor error / System error
- None Output according Namur (3.8mA – 20.5 mA)
 < 4mA to 3.8 mA Measuring range under range
 >20mA to 20.5 mA Measuring range exceeding

To make changes first select a menu item "Current Error" with button „**△**“ and then select by pressing the „**OK**“ the desired mode

For saving the changes done press button „**Save**“ to discard the changes press button „**Cancel**“.

Leaving the menu with „**Back**“.

10.3.7 VA 521 Info

Settings → Info

*** Info ***	
Production Datas	
Serial No.:1234567890	Details
Cal. Date: 10.01.2013	
Sensor Datas	
Sensor Type:	IST 1.8
Max Speed:	92,7 m/s 600m³/h
Max Temp:	100.0 °C
Live Datas	
Run Time:	2d 21h 23m 12s
Vin: 23,8V	Temp: 35,8
Options	Back

*** Calibration Details ***	
Calibration Conditions	
Ref. Pressure:	1000.00mbar
Ref. Temperature:	20 °C
Cal. Diameter:	53,1 mm
Cal. Pressure:	6000.00mbar
Cal. Temperature:	23 °C
Cal. Points:	10
Back	

Here you get a brief description of the sensor data incl. the calibration data.

Under *Details*, you are able to see in addition the calibration conditions.

10.4 MBus

The screenshot shows a configuration window titled 'M-Bus'. It contains the following fields and controls:

- Adr:** 1
- Baudrate:** 2400
- ID:** 123456
- Units as String:**
- back:** A blue button at the bottom right.

The screenshot shows the same configuration window as above, but with the 'Units as String' checkbox checked. It also includes 'Save' and 'Cancel' buttons at the bottom.

The Sensor offers two possibilities for coding the Value Information Field (VIF).

- Primary VIF (The units and multiplier correspond to MBus specification 4.8 chapter 8.4.3)
- Plain text VIF ((units are transmitted as ASCII characters. So units that are not included in MBus specification chapter 8.4.3 are possible)

Switch to Plain Text VIF by activation of „Units as String“.

10.4.1 Default Settings communication

Primary Address*:	1
ID:	Serial number of Sensor
Baud rate*:	2400
Medium*:	depending on medium (Gas or Compressed Air)
Manufacturer ID:	CSI
VIF coding:	Primary VIF

Both addresses, Primary address and ID, could be automatic searched in the M-Bus system.

10.4.2 Default values transmitted

Value 1 with [Unit]*:	Consumption [m ³]
Value 2 with [Unit]*:	Flow [m ³ /h] Consumption [m ³]
Value 3 with [Unit]*:	Gas temperature [°C]

*All Values could be changed / preset in production or with CS Service software (Order-No. 0554 2007)

11 Status / Error messages

11.1 Status messages

- **CAL**

On the part of CS Instruments GmbH & Co.KG a regular re-calibration is recommended, see chapter 13. At delivery, the date at which the next recalibration is recommended is internally entered. When this date is reached, a message appears in the display with the status message „**CAL**“.

Note: The measurement will continue without interruption or restriction.

- **Direction**

When used in conjunction with a direction switch VA409, the status message "Direction" is displayed in case of opposite flow direction and no measurement may take place.

Status messages:

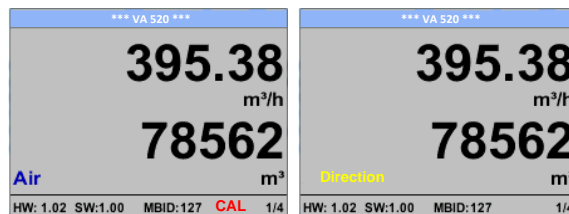

11.2 Error messages

- **Low Voltage**

If the supply voltage is less than 11V, the warning message „**Low Voltage**“ is displayed. This means that the sensor can no longer work / measure correctly and thus there are none measured values for flow, consumption and speed are available.

- **Heater Error**

The error message „**Heater Error**“ occurs in case of failure of the heating sensor.

- **Internal Error**

In the case of this message „**Internal Error**“, the sensor has an internal read error on e.g. EEPROM, AD converter etc. detected.

- **Temp out of Range**

At media temperatures outside the specified temperature range, the status message „**Temp out of Range**“ occurs.

This temperature overshoot leads to incorrect measurement values (outside the sensor specification).

- **Low Voltage 4-20mA**

For sensors with a galvanically isolated 4-20mA output, a min. Supply voltage of 17.5V is required. If this value is undershot, the error message „**Low Voltage 4-20mA**“ is displayed.

Error messages:

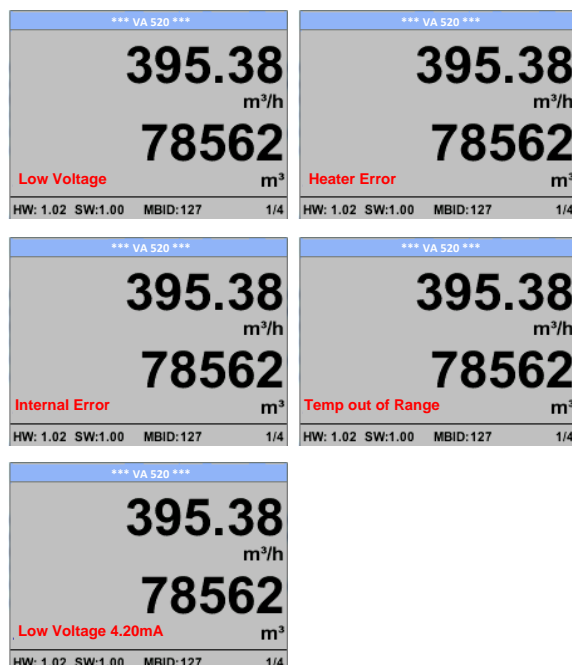

12 Maintenance

The sensor head should be checked regularly for dirt and cleaned if necessary. Should dirt, dust or oil accumulate on the sensor element, a deviation will occur in the measuring value. An annual check is recommended. Should the compressed air be heavily soiled this interval must be shortened.

13 Cleaning of the sensor head

The sensor head can be cleaned by carefully moving it in warm water with a small amount of washing-up liquid. Avoid physical intervention on the sensor (e.g. using a sponge or brush). If soiling cannot be removed, service and maintenance must be carried out by the manufacturer.

14 Re-Calibration

If no customer specifications are given then we recommend to carry out calibration every 12 months. For this purpose the sensor must be sent to the manufacturer.

15 Spare parts and repair

For reasons of measuring accuracy spare parts are not available. If parts are faulty, they must be sent to the supplier for repair.

If the measuring device is used in important company installations, we recommend keeping a spare measuring system ready.

16 Calibration

According to DIN ISO certification of the measuring instruments we recommend to calibrate and if applicable to adjust the instruments regularly from the manufacturer. The calibration intervals should comply with your internal specification. According to DIN ISO we recommend a calibration interval of one year for the instrument VA 521.

On request and additional payment, calibration-certificates could be issued. The precision is given due to use DKD-certified flow meters and verifiable

17 Warranty

If you have reason for complaint we will of course repair any faults free of charge if it can be proven that they are manufacturing faults. The fault should be reported immediately after it has been found and within the warranty time guaranteed by us. Excluded from this warranty is damage caused by improper use and non-adherence to the instruction manual.

The warranty is also cancelled once the instrument has been opened - as far as this has not been mentioned in the instruction manual for maintenance purposes - or if the serial number in the instrument has been changed, damaged or removed.

The warranty time for the VA 521 is 12 months. If no other definitions are given the accessory parts have a warranty time of 6 months. Warranty services do not extend the warranty time.

If in addition to the warranty service necessary repairs, adjustments or similar are carried out the warranty services are free of charge but there is a charge for other services such as transport and packaging costs. Other claims, especially those for damage occurring outside the instrument, are not included unless responsibility is legally binding.

After sales service after the warranty time has elapsed

We are of course there for you even after the warranty time has elapsed. In case of malfunctions, please send us the instrument with a short-form description of the fault. Please do not forget to indicate your telephone number so that we can call you in case of any questions.

KONFORMITÄTSERKLÄRUNG

DECLARATION OF CONFORMITY

Wir CS Instruments GmbH & Co.KG
 We Gewerbehof 14, 24955 Harrislee

Erklären in alleiniger Verantwortung, dass das Produkt
 Declare under our sole responsibility that the product

Verbrauchs-/ Durchflusssensor VA 521
 Flow Sensor VA 521

den Anforderungen folgender Richtlinien entsprechen:
 We hereby declare that above mentioned components comply with requirements of the following EU directives:

Elektromagnetische Verträglichkeit Electromagnetic compatibility	2014/30/EU 2014/30/EC
RoHS (Restriction of certain Hazardous Substances)	2011/65/EC

Angewandte harmonisierte Normen:

Harmonised standards applied:

EMV-Anforderungen EMC requirements	EN 55011: 2011-04 EN 61326-1: 2013-07
---------------------------------------	------------------------------------------

Anbringungsjahr der CE Kennzeichnung: 20

Year of first marking with CE Label: 20

Das Produkt ist mit dem abgebildeten Zeichen gekennzeichnet.
 The product is labelled with the indicated mark.



Harrislee, den 04.03.2020

 Wolfgang Blessing Geschäftsführer