



Wireless Low Temperature Sensors

General Description

The [ALTA Wireless Low Temperature Sensor](#) uses a glass-coated platinum resistance temperature detector (RTD) sensor to accurately measure temperatures from -200°C to 0°C (-328°F to +32°F).

- Standard accuracy at 0°C: +/- 3.3°C
- Calibrated accuracy at 0°C: +/- 0.5°C

Principle of Operation

The ALTA Wireless Low Temperature Sensor outputs the ambient temperature in degrees Celsius or Fahrenheit. It's programmed to sleep for a user-given time interval (heartbeat) and then wake up, power up the RTD sensor, and wait for it to stabilize. Then it mathematically computes the temperature and transmits the data to the gateway.

An industry-leading 25-month NIST certification is available on Monnit Low Temperature Sensors.

The ALTA Low Temperature Sensor isn't meant for wet, damp, high-humidity environments. This sensor should only operate in dry, low-humidity environments. The Low Temperature Sensor operates at extremely low temperatures and can withstand external condensation.

Example Applications

- Freezers and coolers
- Environmental monitoring
- Smart machines and structures
- HVAC operation and testing
- [Additional applications](#)

Features of Monnit ALTA Sensors

- Wireless range of 1,200+ feet through 12+ walls¹
- Frequency-Hopping Spread Spectrum (FHSS)
- Best-in-class interference immunity
- Best-in-class power management for longer battery life²
- Encrypt-RF® Security (Diffie-Hellman Key Exchange + AES-128 CBC for sensor data messages)
- Data logs 2000 to 4000 readings if the gateway connection is lost (non-volatile flash, persists through the power cycle):
 - 10-minute heartbeats = ~ 22 days
 - 2-hour heartbeats = ~ 266 days
- Over-the-air updates (future-proof)
- Free iMonnit Basic Online Wireless Sensor Monitoring and Notification System to configure sensors, view data, and set alerts to be sent via SMS text and email

1 Actual range may vary depending on the environment.

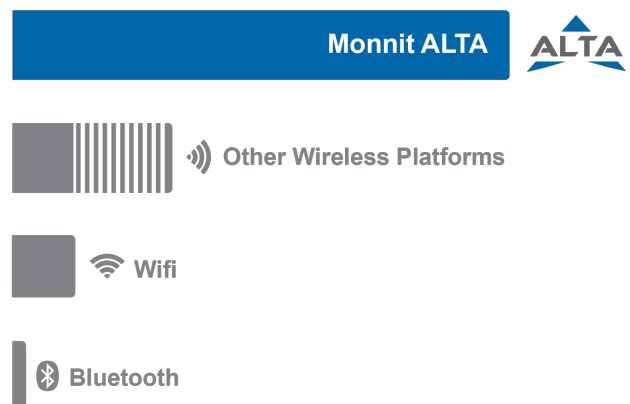

2 Battery life is determined by the sensor reporting frequency and other variables. Other power options are also available.

Wireless Range Comparison

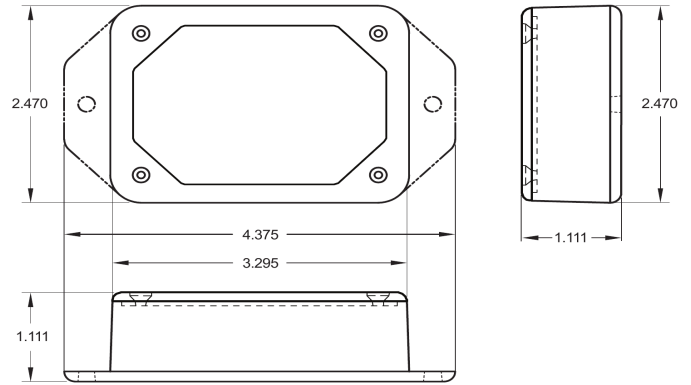



ALTA Commercial AA Wireless Low Temperature Sensor | Technical Specifications

Supply voltage	2.0–3.8 VDC (3.0–3.8 VDC using power supply) ¹
Current consumption	0.2 μ A (sleep mode), 0.7 μ A (RTC sleep), 570 μ A (MCU idle), 2.5 mA (MCU active), 5.5 mA (radio RX mode), 22.6 mA (radio TX mode)
Operating temperature range (board circuitry and batteries)	-18°C to 55°C (0°F to 130°F) using alkaline -40°C to 85°C (-40°F to 185°F) using lithium
Optimal battery temperature range (AA)	+10°C to +50°C (+50°F to +122°F)
RTD temperature range (RTD and cable only)	-200°C to 0°C (-328°F to +32°F)
Accuracy @ 0°C	+/- 3.3°C Standard (+/- 0.5°C Calibrated) ²
Dissipation constant	2mW/°C
Thermal time constant	15 sec max
Data logging	Data logs 2000 to 4000 readings if the gateway connection is lost (non-volatile flash, persists through the power cycle): - 10-minute heartbeats = ~ 22 days - 2-hour heartbeats = ~ 266 days
Wireless range	1,200+ ft non-line-of-sight
Security	Encrypt-RF® (256-bit key exchange and AES-128 CTR)
Weight	3.7 ounces
Lead	Probe type – 316 stainless steel Dimensions – 4.8 mm x 25mm
Certifications	  Industry Canada 900 MHz product; FCC ID: ZTL-G2SC1 and IC: 9794A-G2SC1. 868 and 433 MHz product tested and found to comply with: EN 300 220-2 V3.1.1 (2017-02), EN 300 220-2 V3.1.1 (2017-02), and EN 60950

¹ Hardware cannot withstand negative voltage. Please take care when connecting a power device.

² See RTD accuracy chart on last page.

Power Options



Two two replaceable 1.5V AA-sized batteries (included with purchase) power the standard version of this sensor.

This sensor is also available with a line-power option. The line-powered version of this sensor has a barrel power connector allowing it to be powered by a standard 3.0–3.6V power supply. The line-powered version also uses two standard 1.5V AA batteries as backup for uninterrupted operation in the event of a line-power outage.

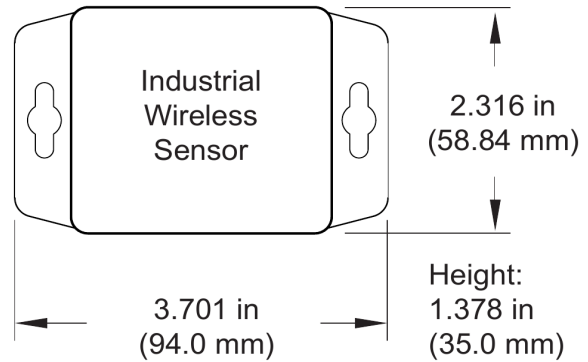
Power options must be selected at the time of purchase, as the internal hardware of the sensor must be changed to support the selected power requirements.



ALTA Industrial Wireless Low Temperature Sensor | Technical Specifications

Supply voltage	2.0–3.8 VDC (3.0–3.8 VDC using power supply) ¹	
Current consumption	0.2 μ A (sleep mode), 0.7 μ A (RTC sleep), 570 μ A (MCU idle), 2.5 mA (MCU active), 5.5 mA (radio RX mode), 22.6 mA (radio TX mode)	
Operating temperature range (board circuitry and battery)	-40°C to +85°C (-40°F to +185°F)	
Included battery	Max temperature range	-40° to +85°C (-40° to +185°F)
	Capacity	1500 mAh
Optional solar feature	Solar panel	5VDC/30mA (53mm x 30mm)
	Charging temperature range	0° to 45°C (32° to 113°F)
	Max temperature range	-20° to 60°C (-4° to 140°F)
	Included rechargeable battery	600 mAh/>2000 charge cycles (80% of initial capacity)
	Solar efficiency	Optimized for high and low-light operation ²
	Charging efficiency	5% ⁴
Luminous sustainability	Minimum of 10,000 LUX ⁴	
RTD temperature range (RTD and cable only)	-200°C to 0°C (-328°F to +32°F)	
Accuracy @ 0°C	+/- 3.3°C Standard (+/- 0.5°C Calibrated) ³	
Dissipation constant	2mW/°C	
Thermal time constant	15-sec max	
Data logging	Data logs 2000 to 4000 readings if gateway connection is lost (non-volatile flash, persists through the power cycle): - 10-minute heartbeats = ~ 22 days - 2-hour heartbeats = ~ 266 days	
Wireless range	1,200+ ft non-line-of-sight	
Security	Encrypt-RF® (256-bit key exchange and AES-128 CTR)	
Weight	4.7 Ounces	
Enclosure rating	NEMA 1, 2, 4, 4x, 12 and 13 rated, sealed and weatherproof	
UL rating	UL Listed to UL508-4x specifications (File E194432)	
Lead	Probe: 316 stainless steel. Dimensions: 4.8 mm x 25 mm	
Certifications	 	900 MHz product; FCC ID: ZTL-G2SC1 and IC: 9794A-G2SC1. 868 and 433 MHz product tested and found to comply with: EN 300 220-2 V3.1.1 (2017-02), EN 300 220-2 V3.1.1 (2017-02), and EN 60950

¹ Hardware cannot withstand negative voltage. Please take care when connecting a power device.

² Light present 25% of day yields 125% of the operating power to support 10-minute heartbeats.

³ See RTD accuracy chart on last page.

⁴ Solar feature's energy harvesting circuitry works indoors with low light.

RTD Accuracy		
Temperature (°C)	Accuracy (±°C)	
	Uncalibrated	Calibrated
-200°C	4.30	1.50
-180°C	4.20	1.40
-160°C	4.10	1.30
-140°C	4.00	1.20
-120°C	3.90	1.10
-100°C	3.80	1.00
-80°C	3.70	0.90
-60°C	3.60	0.80
-40°C	3.50	0.70
-20°C	3.40	0.60
0°C	3.30	0.50
20°C	3.40	0.60
40°C	3.50	0.70
60°C	3.60	0.80
80°C	3.70	0.90
100°C	3.80	1.00
120°C	3.90	1.10
140°C	4.00	1.20
160°C	4.10	1.30

Warning

Low Temperature Sensors should not be used in submersible applications. It **may** be used in liquid nitrogen applications without any concern of sensor failure.

Commercial-Grade Sensors

Monnit commercial-grade sensors are designed for applications in ordinary environments (normal room temperature, humidity, and atmospheric pressure). Do not use these sensors under the following conditions as these factors can deteriorate the product characteristics and cause failures and burnout.

- Corrosive gas or deoxidizing gas: chlorine gas, hydrogen sulfide gas, ammonia gas, sulfuric acid gas, nitric oxide gas, etc.
- Volatile or flammable gas
- Dusty conditions
- Low-pressure or high-pressure environments
- Wet or excessively humid locations
- Places with salt water, oils, chemical liquids, or organic solvents
- Where there are excessively strong vibrations
- Other places where similar hazardous conditions exist

Use these products within the specified temperature range. Higher temperature may cause deterioration of the characteristics or the material quality.

Industrial-Grade Sensors | Type 1, 2, 4, 4X, 12, and 13 NEMA-Rated Enclosure

Monnit's industrial sensors are enclosed in reliable, weatherproof NEMA-rated enclosures. Our NEMA-rated enclosures are constructed for both indoor or outdoor use and protect the sensor circuitry against the ingress of solid foreign objects like dust and the damaging effects of water.

- Safe from falling dirt
- Protects against wind-blown dust
- Protects against rain, sleet, snow, splashing water, and hose-directed water
- Increased level of corrosion resistance
- Will remain undamaged by ice formation on the enclosure