



## Remote Monitoring for Business



# Wireless Accelerometer - G-Force Snapshot Sensor

### General Description

Monnit's [ALTA® Wireless G-Force Snapshot Sensor](#) activates at a user-set time to measure acceleration on the X, Y, and Z axes to determine G-force. This digital, low-power sensor's applications include tracking machine inclination or tilt, detecting asset orientation, or testing for vibrations.

Users can configure the G-Force Snapshot Sensor to activate at set times. If the sensor detects an abnormality (based on user-defined limits) during measurement, the user is alerted via email, text, or call.

### Principle of Operation

The ALTA Wireless Accelerometers - G-Force Snapshot Sensor [Accelerometer](#) activates at a set time interval (defined by user) and measures g-force along X, Y and Z axes. Primary use is as an inclinometer or tilt sensor. The data is displayed as g-force on each axis.

Example: X: 0.001 Y: 0.031 Z: 1.01

### Example Applications

- [Inclination and Vibration Testing](#)
- [Assembly Line Monitoring](#)
- [Orientation Sensing](#)
- [Impact Load Sensing](#)
- [Additional applications](#)

### Features of Monnit ALTA Sensors

- Wireless range of 1,200+ feet through 12+ walls \*
- Frequency-Hopping Spread Spectrum (FHSS)
- Improved interference immunity
- Improved power management for longer battery life \*\*
- Encrypt-RF® Security (Diffie-Hellman Key Exchange + AES-128 CBC for sensor data messages)
- All ALTA sensors now have up to 3200 readings:
  - 10-minute heartbeats = 22 days
  - 2-hour heartbeats = 266 days
- Over-the-air updates (future proof)
- Free iMonnit basic online wireless sensor monitoring and notification system to configure sensors, view data and set alerts via SMS text and email

\*Actual range may vary depending on environment.

\*\*Battery life is determined by sensor reporting frequency and other variables. Other power options are also available.

### WIRELESS RANGE COMPARISON

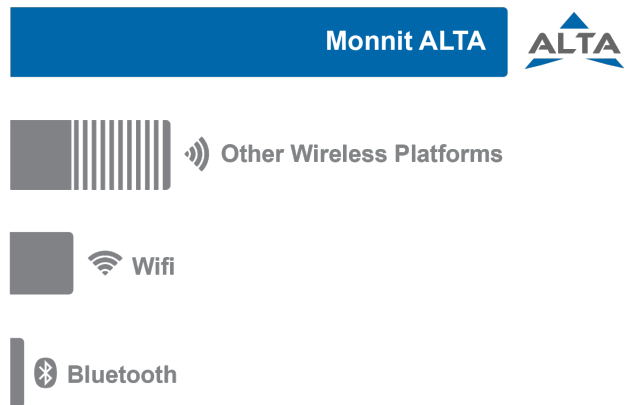



### Monnit Wireless Accelerometer Orientation (Commercial Coin Cell)

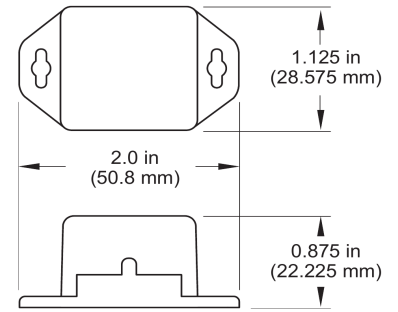
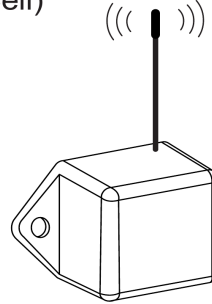
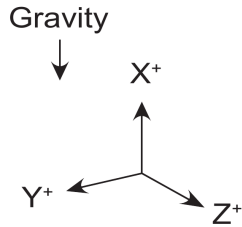

## ALTA Commercial Coin Cell Wireless Accelerometer - G-Force Snapshot | Technical Specifications

Supply voltage	2.0–3.8 VDC *
Current consumption	0.2 $\mu$ A (sleep mode), 0.7 $\mu$ A (RTC sleep), 570 $\mu$ A (MCU idle), 2.5 mA (MCU active), 5.5 mA (radio RX mode), 22.6 mA (radio TX mode)
Operating temperature range (board circuitry and coin cell)	-7°C to +60°C (20°F to +140°F) **
Optimal battery temperature range (coin cell)	+10°C to +50°C (+50°F to +122°F)
Sensitivity	4096 count/g
Sensitivity Range	+/- 2 G
Measurement accuracy	$\pm$ 2.5 % (force: X, Y, Z)
Minimum g-force to turn on/wake up	0.050–0.100 g
Fastest update interval/heart rate in any configuration	Heartbeat: 1 minute
Bandwidth for data measurement	800 Hz
Integrated memory	Up to 3200 sensor messages
Wireless range	1,200+ ft non-line-of-sight
Security	Encrypt-RF® (256-bit key exchange and AES-128 CTR)
Weight	0.7 ounces
Certifications	 900 MHz product; FCC ID: ZTL-G2SC1 and IC: 9794A-G2SC1. 868 and 433 MHz product tested and found to comply with: EN 300 220-2 V3.1.1 (2017-02), EN 300 220-2 V3.1.1 (2017-02) and EN 60950

\* Hardware cannot withstand negative voltage. Please take care when connecting a power device.

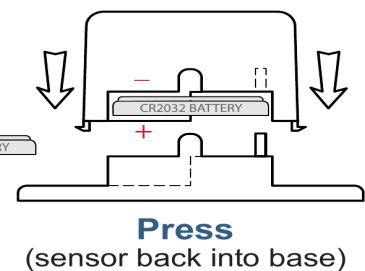
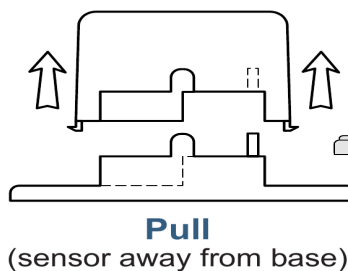
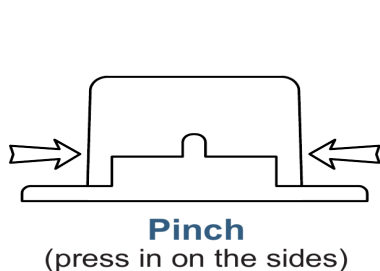

\*\* At temperatures above 100°C, it is possible for the board circuitry to lose programmed memory.

## PinchPower™ Enclosures

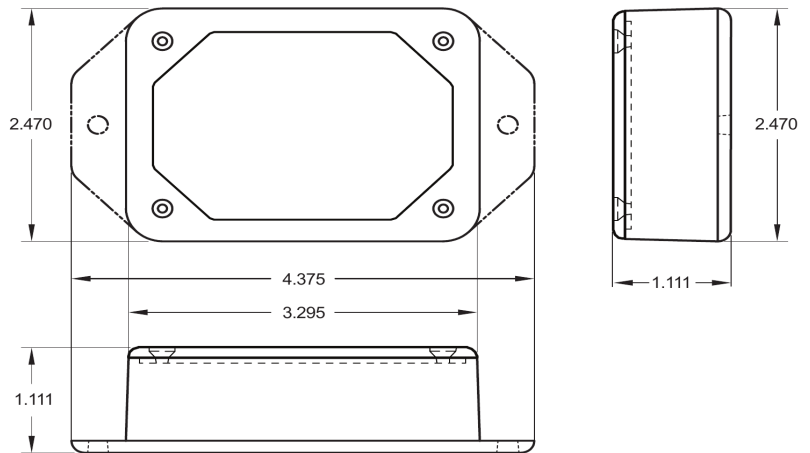



### ALTA Commercial AA Wireless Accelerometer - G-Force Snapshot | Technical Specifications

Supply voltage	2.0–3.8 VDC (3.0–3.8 VDC using power supply) *
Current consumption	0.2 $\mu$ A (sleep mode), 0.7 $\mu$ A (RTC sleep), 570 $\mu$ A (MCU idle), 2.5 mA (MCU active), 5.5 mA (radio RX mode), 22.6 mA (radio TX mode)
Operating temperature range (board circuitry and batteries)	-18°C to 55°C (0°F to 130°F) using alkaline -40°C to 85°C (-40°F to 185°F) using lithium **
Optimal battery temperature range (AA)	+10°C to +50°C (+50°F to +122°F)
Sensitivity	4096 count/g
Sensitivity Range	+/- 2 G
Measurement accuracy	$\pm$ 2.5 % (force: X, Y, Z)
Minimum g-force to turn on/wake up	0.050–0.100 g
Fastest update interval/heart rate in any configuration	Heartbeat: 1 minute
Bandwidth for data measurement	800 Hz
Integrated memory	Up to 3200 sensor messages
Wireless range	1,200+ ft non-line-of-sight
Security	Encrypt-RF® (256-bit key exchange and AES-128 CTR)
Weight	3.7 ounces
Certifications	   Industry Canada 900 MHz product; FCC ID: ZTL-G2SC1 and IC: 9794A-G2SC1. 868 and 433 MHz product tested and found to comply with: EN 300 220-2 V3.1.1 (2017-02), EN 300 220-2 V3.1.1 (2017-02) and EN 60950

\* Hardware cannot withstand negative voltage. Please take care when connecting a power device.



\*\* At temperatures above 100°C, it is possible for the board circuitry to lose programmed memory.

### Power Options

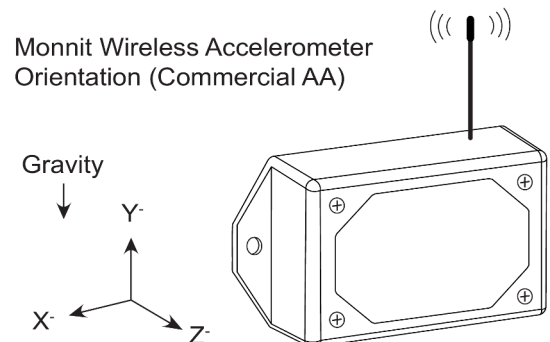
The standard version of this sensor is powered by two replaceable 1.5 V AA sized batteries (included with purchase). This sensor is also available with a line power option. The line powered version of this sensor has a barrel power connector allowing it to be powered by a standard 3.0–3.6 V power supply. The line powered version also uses two standard 1.5 V AA batteries as backup for uninterrupted operation in the event of line power outage. Power options must be selected at time of purchase, as the internal hardware of the sensor must be changed to support the selected power requirements.

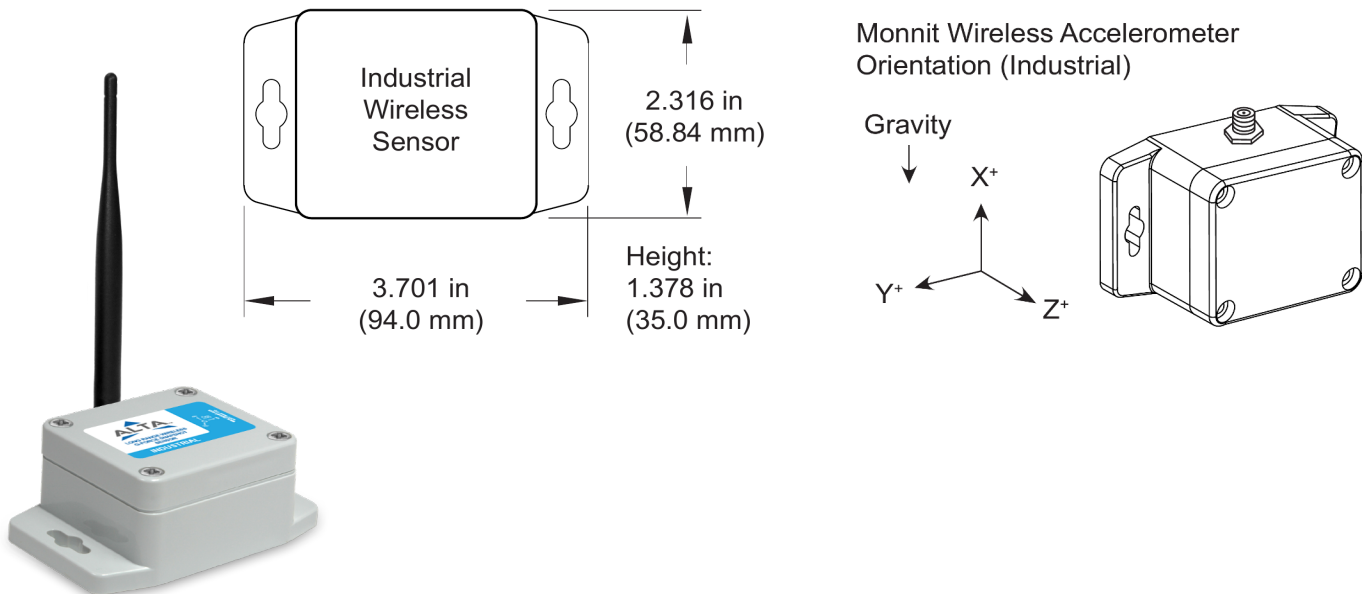



ALTA Industrial Wireless Accelerometer - G-Force Snapshot   Technical Specifications		
Supply voltage		2.0–3.8 VDC (3.0–3.8 VDC using power supply) *
Current consumption		0.2 $\mu$ A (sleep mode), 0.7 $\mu$ A (RTC sleep), 570 $\mu$ A (MCU idle), 2.5 mA (MCU active), 5.5 mA (radio RX mode), 22.6 mA (radio TX mode)
Operating temperature range (board circuitry and battery)		-40°C to +85°C (-40°F to +185°F) **
Included battery	Max temperature range	-40° to +85°C (-40° to +185°F)
	Capacity	1500 mAh
Optional solar feature	Solar panel	5VDC/30mA (53mm x 30mm)
	Charging temperature range	0° to 45°C (32° to 113°F)
	Max temperature range	-20° to 60°C (-4° to 140°F)
	Included rechargeable battery	600 mAh/>2000 charge cycles (80% of initial capacity)
	Solar efficiency	Optimized for high and low-light operation ***
	Charging efficiency	40% ****
Luminous sustainability		250 LUX ****
Sensitivity		4096 count/g
Sensitivity Range		+/- 2 G
Measurement accuracy		$\pm$ 2.5 % (force: X, Y, Z)
Minimum g-force to turn on/wake up		0.050–0.100 g
Fastest update interval/heart rate in any configuration		Heartbeat: 1 minute
Bandwidth for data measurement		800 Hz
Integrated memory		Up to 3200 sensor messages
Wireless range		1,200+ ft non-line-of-sight
Security		Encrypt-RF® (256-bit key exchange and AES-128 CTR)
Weight		4.7 ounces
Enclosure rating		NEMA 1, 2, 4, 4x, 12 and 13 rated, sealed and weather proof
UL rating		UL Listed to UL508-4x specifications (File E194432)
Certifications	   Industry Canada	900 MHz product; FCC ID: ZTL-G2SC1 and IC: 9794A-G2SC1. 868 and 433 MHz product tested and found to comply with: EN 300 220-2 V3.1.1 (2017-02), EN 300 220-2 V3.1.1 (2017-02) and EN 60950

\* Hardware cannot withstand negative voltage. Please take care when connecting a power device.  
 \*\* At temperatures above 100°C, it is possible for the board circuitry to lose programmed memory.  
 \*\*\* Light present 25% of day yields 125% of operating power to support 10-minute heartbeats.  
 \*\*\*\* Solar feature's energy harvesting circuitry works indoors with low light.

## Commercial Grade Sensors

Monnit commercial grade sensors are designed for applications in ordinary environments (normal room [temperature](#), [humidity](#) and [atmospheric pressure](#)). Do not use these sensors under the following conditions as these factors can deteriorate the product characteristics and cause failures and burnout.

- Corrosive gas or deoxidizing gas: chlorine gas, hydrogen sulfide gas, ammonia gas, sulfuric acid gas, nitric oxides gas, etc.
- Volatile or flammable gas
- Dusty conditions
- Low-pressure or high-pressure environments
- Wet or excessively humid locations
- Places with salt water, oils chemical liquids or organic solvents
- Where there are excessively strong vibrations
- Other places where similar hazardous conditions exist

Use these products within the specified temperature range. Higher temperature may cause deterioration of the characteristics or the material quality.

## Industrial Grade Sensors | Type 1, 2, 4, 4X, 12 and 13 NEMA Rated Enclosure

Monnit's Industrial sensors are enclosed in reliable, weatherproof NEMA-rated enclosures. Our NEMA-rated enclosures are constructed for both indoor or outdoor use and protect the sensor circuitry against the ingress of solid foreign objects like dust as well as the damaging effects of water (rain, sleet, snow, splashing water, and hose-directed water).

- Safe from falling dirt
- Protects against wind-blown dust
- Protects against rain, sleet, snow, splashing water, and hose-directed water
- Increased level of corrosion resistance
- Will remain undamaged by ice formation on the enclosure