



Vibration monitoring unit HE101 series

MADE IN
GERMANY



IECEE



IECEX



Proc. Cont. Eq.
for Ord. Loc.
Proc. Cont. Eq.
for Haz. Loc.



- Vibration velocity (mm/s, rms)
- ATEX / IECEx / EACEx Zone 1 / 2 / 21 / 22
- Temperature (°C)
- Analogue current output: 4–20 mA
- Frequency ranges: 10 Hz–1,000 Hz
1 Hz–1,000 Hz

Manufacturing date: _____

Type designation: _____

Serial number: _____

Operating instructions

Vibration Monitoring Unit Type HE101

Standard and ATEX / IECEx / EACEx

Version: 2021-06-14

Attention!

Prior to commissioning the product, the instruction manual must be read and understood.

1 Contents

| | | |
|------|--|----|
| 1 | Contents..... | 3 |
| 2 | Safety information | 4 |
| 3 | Scope of this instruction manual | 4 |
| 4 | The HE101-type vibration monitoring unit | 5 |
| 5 | Intended use | 5 |
| 6 | Scope of supply | 5 |
| 7 | Documents and Certificates..... | 5 |
| 8 | Transfer of liability when operating in potentially explosive atmospheres..... | 5 |
| 9 | Application areas and type plate examples | 6 |
| 10 | General Conditions for Safe Operation..... | 7 |
| 10.1 | HE101.01 (protection 'pressure resistant housing')..... | 7 |
| 11 | Technical data..... | 8 |
| 11.1 | General data | 8 |
| 11.2 | Electrical data | 8 |
| 11.3 | Permitted operating temperature ranges..... | 9 |
| 11.4 | Operating range of the vibration monitoring unit | 10 |
| 11.5 | Typical frequency response..... | 11 |
| 11.6 | Mechanical data..... | 12 |
| 11.7 | Housing dimensions..... | 12 |
| 12 | Connections | 14 |
| 13 | Assembly and disassembly..... | 15 |
| 13.1 | General notes | 15 |
| 13.2 | Fixing the vibration monitoring unit to the mounting surface | 15 |
| 14 | Installation and commissioning..... | 16 |
| 14.1 | General notes | 16 |
| 14.2 | Wiring diagram..... | 16 |
| 15 | Maintenance and repair | 18 |
| 15.1 | General notes | 18 |
| 15.2 | Fault resolution table | 18 |
| 16 | Transport, storage and disposal | 19 |
| 17 | Accessories..... | 19 |
| 18 | HE101 type code | 20 |
| 19 | EU-Declaration of conformity | 21 |

2 Safety information

2.1 General

The safety instructions are intended to protect people and property from damage and hazards that could arise as the result of improper use, incorrect operation or other misuse or devices, especially in explosive areas. Therefore, please read the operating instructions carefully before working on the product or operating it. The operating instructions must be accessible to operating personnel at all times.

Please make sure that all documents are present and complete before commissioning or performing other work on the product. If the documents have not all been delivered in full or if further copies are necessary, they can also be obtained in other languages.

The product is built according to the latest state of the art. However, hazards to people, machinery and systems can still arise as the result of improper handling, unintended use or operation and maintenance by persons inadequately trained on the product.

All those who are involved in the installation, operation and maintenance of the product in the operator's plant must read and understand the operating instructions.

The product may only be assembled, disassembled, installed and repaired by instructed, sufficiently trained and authorised personnel.

2.2 Symbols used



This symbol indicates an explosion hazard.



This symbol indicates a hazard from electrical current.



This symbol indicates information unrelated to safety.

3 Scope of this instruction manual

This instruction manual for the HE101-type vibration monitoring unit applies to the following variants:

Standard / ATEX / IECEx / EACEx

The functionality of the versions is identical. The ATEX / IECEx / EACEx versions also possess certifications and labels which permit use in potentially explosive atmospheres. For further information, see chapter "Application areas" on page 6.

4 The HE101-type vibration monitoring unit

The HE101-type vibration monitoring unit is used to measure and monitor absolute bearing vibrations and temperatures in machines in line with the standard DIN ISO 10816.

It has the following features:

- Measurement value: The effective value (rms) of the vibration velocity in mm/s, in accordance with DIN ISO 2954.
- Measurement value: The temperature in °C
- Two analogue current outputs: Interference-free DC signal from 4–20 mA, proportional to the measuring range of the monitoring unit.
- Cable breaks on the monitoring cable can be detected by a downstream evaluation component: DC signal value < 3.5 mA.

5 Intended use

The HE101-type is used exclusively for measuring mechanical vibrations and temperatures in machines and mechanical systems. Its use is only permissible within the specifications stated in the data sheet. **Main fields of application:** Fans, ventilators, blowers, electric motors, pumps, centrifuges, separators, generators, turbines and similar oscillating mechanical systems.

6 Scope of supply

All versions include:

- Vibration monitoring unit
- Instruction Manual

7 Documents and Certificates

You can find the following documents and certificates for HE101 type at www.hauber-el-ektronik.de where they can be viewed and downloaded:

- EU type examination certificate ATEX, no.: PTZ 16 ATEX 0029 X Rev 3
- IECEx certificate of conformity, no.: PTZ 18.0009 X Rev 2
- UL certificate of conformity, no.: E507077-20191126
- EACEx certificate RU C-DE.HA65.B.00053/19
- EAC Declaration













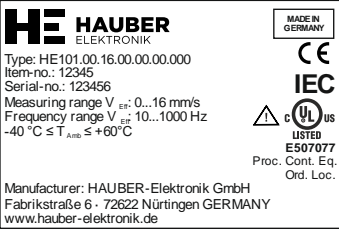



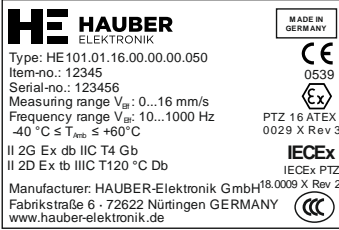

8 Transfer of liability when operating in potentially explosive atmospheres

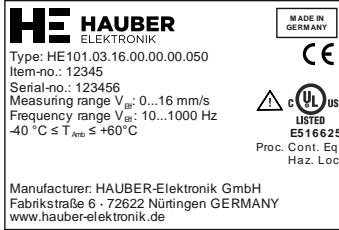
The owner of the system is exclusively liable for the appropriate configuration of the electrical connections with respect to explosion protection regulations and correct commissioning.

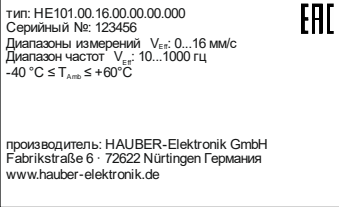
If the system is installed by a sub-contractor on behalf of the owner, the system may only be commissioned after the sub-contractor has issued written confirmation in the form of a certificate of installation that the system has been installed correctly and professionally in accordance with the applicable legal regulations.

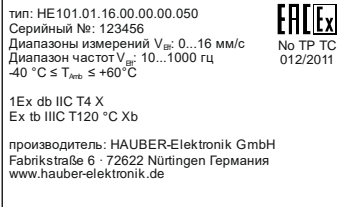
The operator is obliged to notify the responsible authorities of the initial commissioning of explosion-protected systems or system components and their re-commissioning following extensive changes or maintenance.

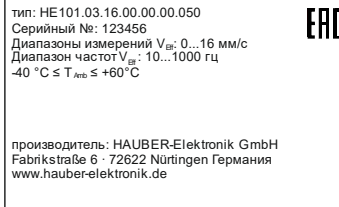
9 Application areas and type plate examples

| | HE101.00 | HE101.01 | HE101.03 |
|------------------|---|--|--|
| Version | Standard CE / IEC / EAC UL Proc. Cont. Eq. Ord. Loc. | ATEX / IECEx / EACEx Pressure-resistant casing, Ex db Protection through housing, Ex tb | UL Proc. Cont. Eq. Haz. Loc. Division 2 |
| Application area | Atmospheres not at risk of explosion | Potentially explosive atmospheres of zones 1 and 21 2 and 22 | Potentially explosive atmospheres of division 2 |
| Marking |  E507077 Process Control Equipment for Ordinary Location |  II 2G Ex db IIC T4 Gb II 2D Ex tb IIIC T120 °C Db -40 °C ≤ T _{Amb} ≤ +60°C PTZ 16 ATEX 0029 X Rev 3 IECEx Ex db IIC T4 Gb Ex tb IIIC T120 °C Db -40 °C ≤ T _{Amb} ≤ +60°C IECEx PTZ 18.0009 X Rev 2 EACEx 1Ex db IIC T4 X Ex tb IIIC T120 °C X -40 °C ≤ T _{Amb} ≤ +60°C № TP TC 012/2011 |  Class I, Division 2, Groups A, B, C and D, T4 Class II, Division 2, Groups F and G, T4 E516625 Process Control Equipment for Hazardous Location |
| Type plate |  <p> HE HAUBER ELEKTRONIK Type: HE101.00.16.00.00.00.000 Item-no.: 12345 Serial-no.: 123456 Measuring range V_{gr}: 0...16 mm/s Frequency range V_{gr}: 10...1000 Hz -40 °C ≤ T_{Amb} ≤ +60°C    E507077 Proc. Cont. Eq. Ord. Loc. Manufacturer: HAUBER-Elektronik GmbH Fabrikstraße 6 · 72622 Nürtingen GERMANY www.hauber-elektronik.de </p> |  <p> HE HAUBER ELEKTRONIK Type: HE101.01.16.00.00.00.050 Item-no.: 12345 Serial-no.: 123456 Measuring range V_{gr}: 0...16 mm/s Frequency range V_{gr}: 10...1000 Hz -40 °C ≤ T_{Amb} ≤ +60°C   PTZ 16 ATEX 0029 X Rev 3 IECEx IECEx PTZ  Manufacturer: HAUBER-Elektronik GmbH Fabrikstraße 6 · 72622 Nürtingen GERMANY www.hauber-elektronik.de </p> |  <p> HE HAUBER ELEKTRONIK Type: HE101.03.16.00.00.00.050 Item-no.: 12345 Serial-no.: 123456 Measuring range V_{gr}: 0...16 mm/s Frequency range V_{gr}: 10...1000 Hz -40 °C ≤ T_{Amb} ≤ +60°C   E516625 Proc. Cont. Eq. Haz. Loc. Manufacturer: HAUBER-Elektronik GmbH Fabrikstraße 6 · 72622 Nürtingen GERMANY www.hauber-elektronik.de </p> |
| |  <p> тип: HE101.00.16.00.00.00.000 Серийный №: 123456 Диапазоны измерений V_{gr}: 0...16 мм/с Диапазон частот V_{gr}: 10...1000 гц -40 °C ≤ T_{Amb} ≤ +60°C  производитель: HAUBER-Elektronik GmbH Fabrikstraße 6 · 72622 Nürtingen Германия www.hauber-elektronik.de </p> |  <p> тип: HE101.01.16.00.00.00.050 Серийный №: 123456 Диапазоны измерений V_{gr}: 0...16 мм/с Диапазон частот V_{gr}: 10...1000 гц -40 °C ≤ T_{Amb} ≤ +60°C  No TP TC 012/2011 производитель: HAUBER-Elektronik GmbH Fabrikstraße 6 · 72622 Nürtingen Германия www.hauber-elektronik.de </p> |  <p> тип: HE101.03.16.00.00.00.050 Серийный №: 123456 Диапазоны измерений V_{gr}: 0...16 мм/с Диапазон частот V_{gr}: 10...1000 гц -40 °C ≤ T_{Amb} ≤ +60°C  производитель: HAUBER-Elektronik GmbH Fabrikstraße 6 · 72622 Nürtingen Германия www.hauber-elektronik.de </p> |

Standards applied

You can find a list of standards, including the related issue dates, in the EU type examination certificate for the vibration monitoring unit.

10 General Conditions for Safe Operation

The following conditions must be met for safe operation in potentially explosive atmospheres.

10.1 HE101.01 (protection 'pressure resistant housing')

Electrical data

| | | min | typ. | max. |
|----------------|-------|---------|-----------|---------|
| Supply voltage | U_n | 10 V DC | 24 V DC | 30 V DC |
| Current | I_n | 4 mA | 4...20 mA | 25 mA |

Tabular 1: Electrical data HE101.01

11 Technical data

11.1 General data



Each sensor has one of the measuring and frequency ranges listed. Additional ranges upon request.

Please specify the measuring and frequency range in your query.

| | |
|-----------------------------|--|
| Measuring range: | 0–8 mm/s (only for frequency range > 10 Hz) 0–16 mm/s 0–32 mm/s 0–64 mm/s |
| Temperature measuring range | 0 to +100°C |
| Measurement accuracy: | ±10% (as per DIN ISO 2954) |
| Cross-sensitivity: | < 5% |
| Frequency range: | 10 Hz–1,000 Hz (standard) 1 Hz–1,000 Hz |
| Calibration point | 159.2 Hz and 90% amplitude of the measuring range |
| Maximum acceleration | ±16.5 g |
| Service life | 10 years |
| MTTF | 399 years |

Tab. 2: General data

11.2 Electrical data

| | |
|--|--|
| Output signal: | 2x 4–20 mA (proportional to the measuring range) |
| Voltage supply: | 10–30 V DC |
| Current draw (max.): | 50 mA |
| Apparent ohmic resistance/load (max.): | 500 Ω |
| Fuse*: | 30VDC, 3A, medium blow |

* Ensure that the supply line is protected by a UL-approved fuse for UL-compliant sensor operation.

Tab. 3: Electrical data

11.3 Permitted operating temperature ranges

| Version | Ambient temperature (T_A) | Measuring head temperature (in the fixing area) |
|--|--|--|
| Standard | -40 °C to +60°C | -40 °C to +125°C |
| ATEX / IECEx / EAC Pressure-resistant casing, Ex d Protection through housing, Ex tb | -40 °C to +60 °C | -40 °C to +125°C |

Tab. 4: Permitted operating temperature ranges

11.4 Operating range of the vibration monitoring unit

The operating range is independent of the measuring range. It is deduced from the maximum acceleration, which is 16.5 g across all frequencies. The maximum measurable vibration velocity is determined by the formula

$$v_{max} = \int a_{max}$$

The following applies to sinusoidal vibration

$$v_{max} = \frac{a_{max}}{2\pi f}$$

Fig. 1: shows the operating range of the vibration monitoring unit, which is limited by the maximum measurable vibration velocity in mm/s depending on the frequency in Hz.

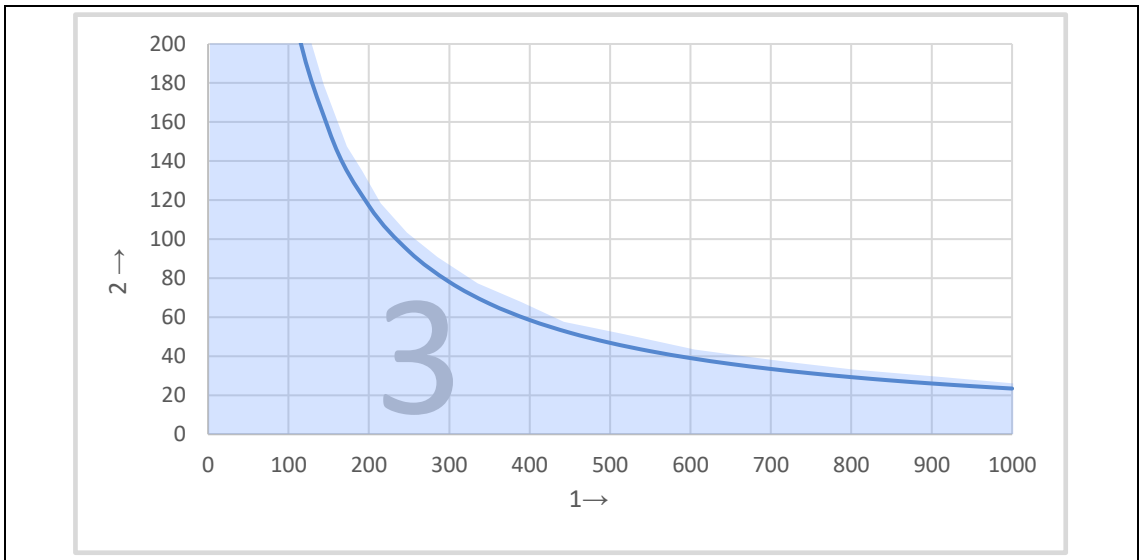

Fig. 1: Operating range diagram

- 1 Frequency in Hz
- 2 Vibration velocity in mm/s
- 3 Operating range of the vibration monitoring unit

Reading examples:

| Frequency (Hz) | Maximum measurable Vibration velocity (mm/s) |
|----------------|--|
| 250 | 103 |
| 400 | 64 |
| 1,000 | 25 |

Tab. 5: Operating range reading examples

11.5 Typical frequency response

10 Hz–1,000 Hz (standard)

The frequency response is recorded using a reference sensor.

- 4 Hz. . . 1200 Hz acceleration sensor

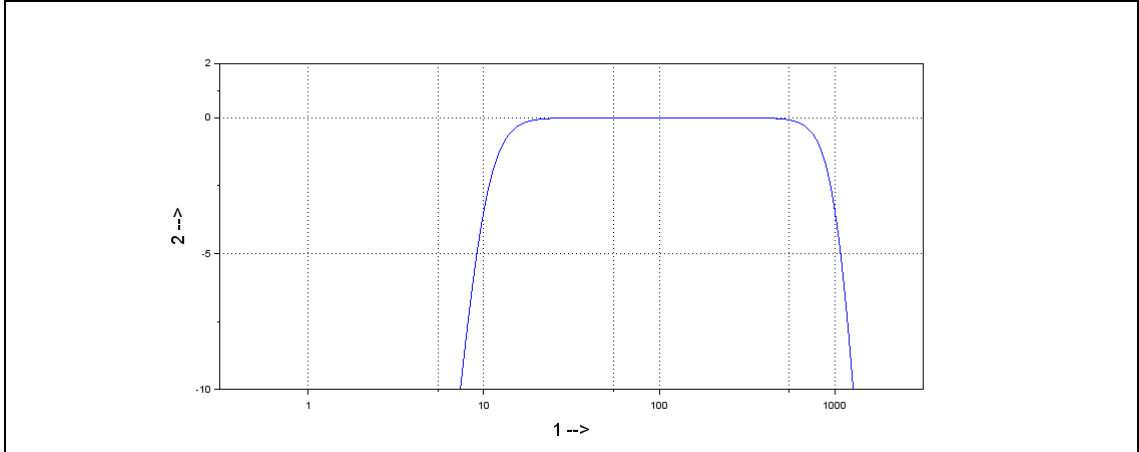

Fig. 2: Typical frequency response 10 Hz–1000 Hz

- 1 Frequency in Hz
- 2 Amplification in dB

1 Hz–1000 Hz

The frequency response is recorded using two reference sensors.

- 1 Hz. . . 10 Hz laser sensor
- 10 Hz. . . 1200 Hz acceleration sensor

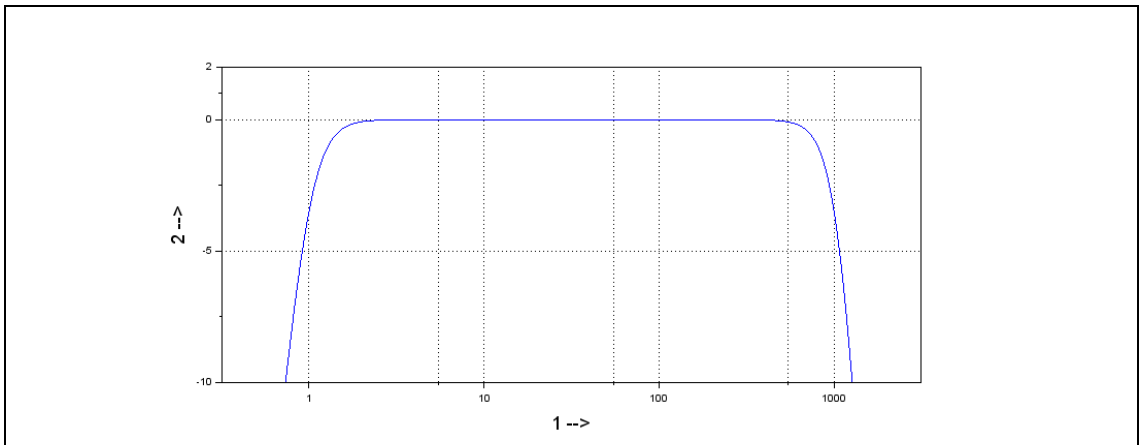

Fig. 3: Typical frequency response 1 Hz–1000 Hz

- 1 Frequency in Hz
- 2 Amplification in dB

11.6 Mechanical data



Additional materials and fixings can be found in section "HE101 type code" on page 20.

| | |
|---|--|
| Housing material: | Stainless steel V2A, material no.: 1.4305 (standard) |
| Fixing: | Width A/F 24 (hex) M8 x 8 mm Incline: 1.25 mm (standard) |
| Assembly type: | Standing/vertical or lying/horizontal |
| Measurement direction | Along the fixing axis |
| Max. torque of the Sensor | 8 Nm |
| Max. torque of the M12 union nut on the connector | 0.4 Nm |
| Weight: | ca. 200 g |
| Protection class: | IP 66/67 (in mated condition) |

Tab. 6: Mechanical data

11.7 Housing dimensions

11.7.1 Version: Standard

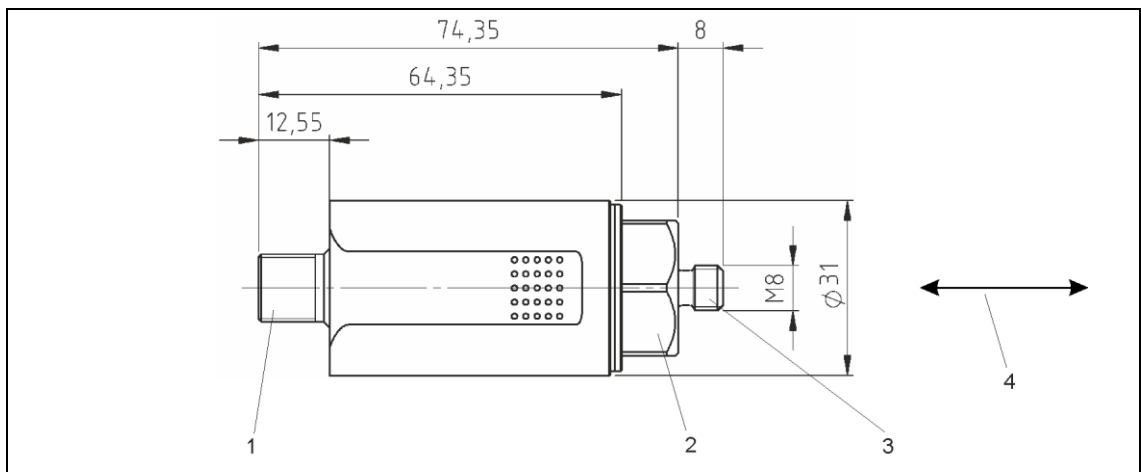

Fig. 4: Housing with M12 connector

All dimensions in mm

- 1 M12 connector
- 2 Width A/F 24
- 3 Fixing
- 4 Measuring direction along the fixing axis

11.7.2 Version: ATEX / IECEx / EACEx Ex d

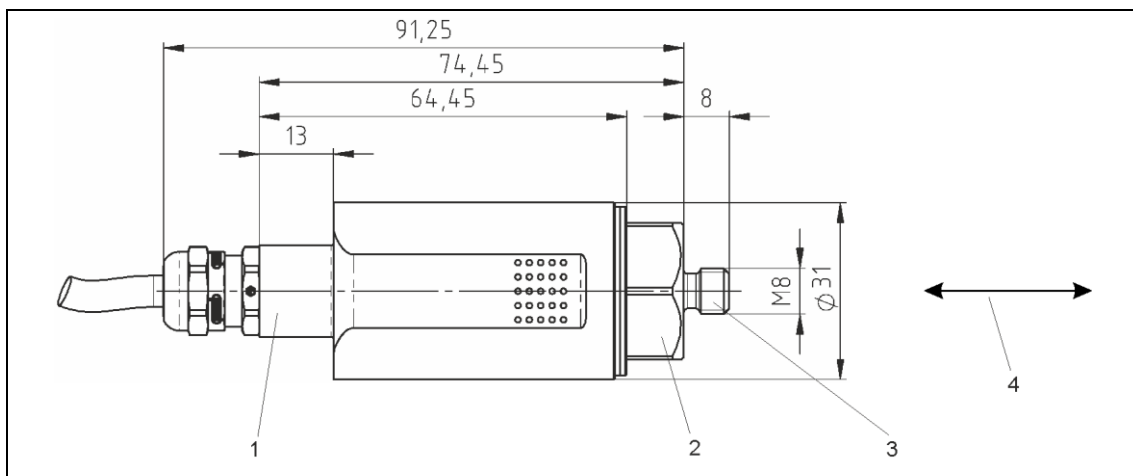
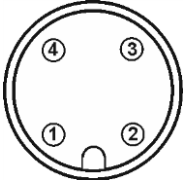

Fig. 5: Housing with integrated cable

All dimensions in mm

- 1 Cable gland for integrated cable
- 2 Width A/F 24
- 3 Fixing
- 4 Measuring direction along the fixing axis

12 Connections

| | |
|---|---|
| Version: | Standard |
| Plug, M12, 4-pole | |
|  | |
| | Pin 1: GND Pin 2: 10...30 V DC Pin 3: 4...20 mA (mm/s) Pin 4: 4...20 mA (°C) |

| | | |
|--|---|---|
| Version: | ATEX / IECEx / EACEx pressure-resistant casing Ex d ATEX / IECEx / EACEx protection through housing, Ex tb | |
| integrated cable | | |
| 1) 2) 3) 4) | brown white blue black | Pin 1: GND Pin 2: 10...30 V DC Pin 3: 4...20 mA (mm/s) Pin 4: 4...20 mA (°C) |
| <i>PUR sheathed cable; Ø: approx. 6.5 mm, 4-pole, 0.34 mm²</i> | | |

13 Assembly and disassembly

13.1 General notes

Assembly and disassembly work on and with the vibration monitoring unit may only be performed by an authorised specialist familiar with the safety regulations governing handling electrical components.



The housing of the vibration monitoring unit must be earthed via the fixing – through the machine earth of the mounting surface or through a separate protective conductor (PE).

13.2 Fixing the vibration monitoring unit to the mounting surface

13.2.1 Prerequisites

- Mounting surface is clean and flat; i.e. free of paint, rust, etc.
- Measuring head area of the vibration monitoring unit must lie flat on the mounting surface.

13.2.2 Tool

- Hex key, width A/F 24

13.2.3 Work steps and instructions

- Screw vibration monitoring unit into the threaded hole of the mounting surface in a friction-locked manner using a hex key. The tightening torque should be 8 Nm.
- The tightening torque of the M12 union nut of the plug connection must not exceed 0.4 Nm



To obtain precise measurement values, the vibration monitoring unit must be fixed to the mounting surface in a friction-locked manner.



Auxiliary structures for fixing are to be avoided. If unavoidable, make them as firm as possible!



Earth/ground loops are amongst the most common problems in measurement set-ups with sensitive sensor technology. These issues arise due to unintentional differences in potential in the electrical circuit between the sensor and evaluation unit. As a countermeasure, we recommend our standard earthing concept or, depending on the application our Alternative earthing concept



Ensure that the earth connection is electrically secure.

14 Installation and commissioning

14.1 General notes

Installation and commissioning the vibration monitoring unit must be performed by an authorised specialist who is familiar with the safety regulations when handling electrical components.



Protect the connection cable and any extension cables from electrical interference or mechanical damage. Comply with the local regulations and directives.

14.2 Wiring diagram

Earth/ground loops are amongst the most common problems in measurement set-ups with sensitive sensor technology. These issues arise due to unintentional differences in potential in the electrical circuit between the sensor and evaluation unit.



Ensure that the earth connection is electrically secure.

14.2.1 Standard earthing concept

With the standard earthing concept, the sensor cable shield has no connection to the sensor housing. The sensor housing has the same potential as the machine earth.



- 1 Machine earth
- 2 Evaluation unit (measuring device, PLC, etc.)
- 3 Blue – 4–20 mA current signal (Vibration velocity)
- 4 Black – 4–20 mA current signal (Vibration velocity)
- 5 Cable shield
- 6 Evaluation unit earth potential

14.2.2 Alternative earthing concept

With the alternative earthing concept, the sensor cable shield is connected to the sensor housing. The sensor housing is uncoupled from the machine earth by means of an EMC adapter (red). With the alternative earthing concept, an electrically secure earth connection can only be ensured for versions with an M12 plug connection. For versions with an integrated cable, the alternative earthing concept cannot be used.

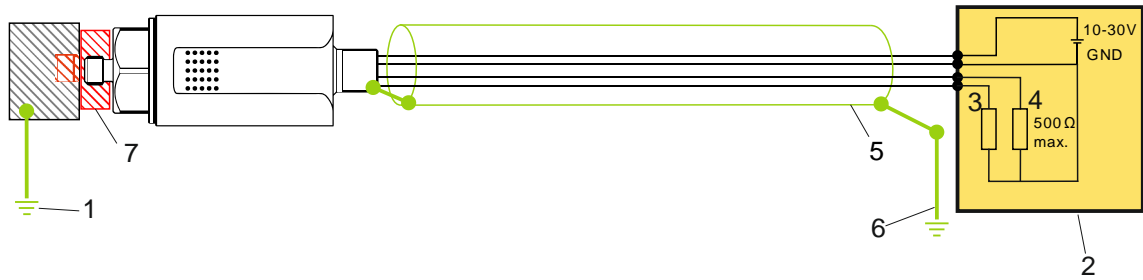

- 1 Machine earth
- 2 Evaluation unit (measuring device, PLC, etc.)
- 3 Blue – 4–20 mA current signal (Vibration velocity)
- 4 Black – 4–20 mA current signal (Vibration velocity)
- 5 Cable shield
- 6 Evaluation unit earth potential
- 7 EMC adapter (Hauber art. no. 10473)



Please advise us if you are opting for the alternative earthing concept when enquiring. We will offer you the relevant sensor cable and the EMC adapter.

15 Maintenance and repair

15.1 General notes



Repair and cleaning work on vibration monitoring units may only be performed by an authorised specialist familiar with the safety regulations governing handling electrical components.



Replace defective cables immediately!
A defective vibration monitoring unit must be completely replaced.



The vibration monitoring unit HE101 is maintenance-free.

15.2 Fault resolution table

| Fault | Cause | Action |
|--------------------------------|--|---|
| No measured value (4-20 mA) | No voltage supply | Check voltage source and/or supply cable |
| | Connection cable interrupted | Replace connection cable |
| | Fuse defective | Replace fuse |
| | Connection has incorrect polarity | Establish correct connection polarity |
| | Vibration monitoring unit defective | Replace vibration control unit |
| Incorrect measurement value | Vibration monitoring unit not friction-locked. | Mount vibration monitoring unit in a friction-locked manner. |
| | Vibration monitoring unit mounted in wrong position. | Mount vibration monitoring unit in correct position. |
| EMC problems | | For further information, see chapter "Alternative earthing concept" on page 17. |

Tab. 7: Fault resolution table

16 Transport, storage and disposal

The sensor must be protected from damaging environmental factors and mechanical damage during transport with the use of adequate packing.

The sensor may not be stored in ambient temperatures outside the permitted operating temperature.

The product contains electronic components and must be disposed of properly in accordance with local laws and regulations.

17 Accessories

| | Standard | ATEX / IECEx Ex d, tb |
|--|----------|-----------------------|
| Accessories | | |
| Factory calibration certificate | x | x |
| Evaluation device types 652 and 656 | x | x |
| HE400-type portable measuring instrument | x | |
| Magnetic base | x | |
| Various mounting adapters; e.g. M8 -> M10 | x | x |
| Configurable mating plug | x | x |
| Connection cable, socket M12, 4-pin, 0.34 mm ² , L= 2 m, 5 m, 10 m, or customised | x | |
| Rubber nozzle | x | x |
| Metallic protective hose | x | x |
| EMC adapter | x | |



For use OUTDOORS or using SPRAY WATER, the vibration monitoring unit should have the rubber nozzle pulled over it for additional protection.



Rubber nozzle

18 HE101 type code

| | | | | | | |
|--------|-----|-----|-----|-----|-----|-----|
| HE101. | 00. | 16. | 01. | 00. | 00. | 000 |
|--------|-----|-----|-----|-----|-----|-----|

HE series

101 = transmitter 4–20 mA ~ mm/s rms
+ Temp. 4–20 mA ~ 0...100°C

ATEX / IECEX / EACEX

00 = No ATEX / IECEX / EACEX
01 = ATEX / IECEX / EACEX Ex d and Ex tb (zones 1 / 2 / 21 / 22)
03 = UL Proc. Cont. Eq. Haz. Loc. Division 2

Measuring range

16 = 16 mm/s rms (standard)
32 = 32 mm/s rms
64 = 64 mm/s rms

Frequency range

00 = 10–1,000 Hz (standard)
01 = 1–1,000 Hz

Housing material

00 = 1.4305 (V2A) (standard)
01 = 1.4404 (V4A)
02 = 1.4462 Duplex stainless steel

Housing fixing thread (standard)

00 = M8 x 8 mm; incline 1.25 mm

Connection

000 = M12 connector (standard)
020 = 2 m integrated cable
050 = 5 m integrated cable
100 = 10 m integrated cable



Is your desired configuration not listed? Please get in touch with us, we can offer you a customer-specific solution.

19 EU-Declaration of conformity

Declaration of conformity

HAUBER-Elektronik GmbH
 Fabrikstraße 6
 D-72622 Nürtingen-Zizishausen

hereby declare, bearing sole responsibility, that the products listed below to which this declaration refers, the essential health and safety requirements are in conformity with the following standards or normative documents.

Product series

HE100, HE101, HE102, HE103

Directives and Standards

| EU-Directives | Standards |
|---------------|--|
| 2014/30/EU | EN 61000-6-2:2005 EN 61000-6-3:2007 + A1:2011 |
| 2014/34/EU | EN 60079-0:2019 EN 60079-1:2014 EN 60079-11:2012 EN 60079-31:2014 |

ATEX annex

UL International Demko A/S **notified body number 0539** for Annex IV in accordance with Article 21 of the Council Directive 2014/34/EU of 26 February 2014, notifies to the applicant that the manufacturer has a production quality system which complies to **Annex IV** of the Directive.

Affixed CE marking



Markings and certificates

HE100.01 / HE101.01 / HE102.01 / HE103.01

| Marking | Certificate |
|--|--------------------------|
| ⚡ II 2 G Ex db IIC T4 Gb ⚡ II 2 D Ex tb IIIC T120 °C Db | PTZ 16 ATEX 0029 X Rev 3 |

HE100.02

| Marking | Certificate |
|--|--------------------------|
| ⚡ II 2 G Ex ib IIC T4 Gb ⚡ II 2 D Ex ib IIIC T125 °C Db | PTZ 16 ATEX 0029 X Rev 3 |

Signature

Nürtingen, April 15th 2021

Place and date

Tobias Bronkal, Managing Proprietor