



Remote Monitoring for Business

Wireless 200 VDC Voltage Meters

General Description

The [Wireless 200 VDC Voltage Meter](#) is an analog measuring device that reports the measured DC voltage on user specified intervals.

- Wireless interface for measuring voltage
- Measures voltage up to 200 VDC

Free iMonnit basic online wireless sensor monitoring and notification system to configure sensors, view data and set alerts via SMS text and email

Principle of Operation

By connecting the leads on the Monnit Wireless 200 VDC Voltage Meter to the positive and negative terminals of another device, battery or sensor, it can measure the DC voltage and send data to the iMonnit Online Sensor Monitoring and Notification System. The data is stored in the online system and can be reviewed and exported as a data sheet or graph. Notifications can be set up through the online system to alert the user when certain thresholds have been met or exceeded.

Example Applications

- Machinery
- Electrical Motors
- DC Generators
- Batteries
- Transducers
- [Additional applications](#)

Features of Monnit ALTA Sensors

- Wireless range of 1,200+ feet through 12+ walls *
- Frequency-Hopping Spread Spectrum (FHSS)
- Best in class interference immunity
- Best in class power management for longer battery life **
- Encrypt-RF® Security (Diffie-Hellman Key Exchange + AES-128 CBC for sensor data messages)
- All ALTA sensors now have up to 3200 readings:
 - 10-minute heartbeats = 22 days
 - 2-hour heartbeats = 266 days
- Over-the-air updates (future proof)
- Free iMonnit basic online wireless sensor monitoring and notification system to configure sensors, view data and set alerts via SMS text and email

*Actual range may vary depending on environment.

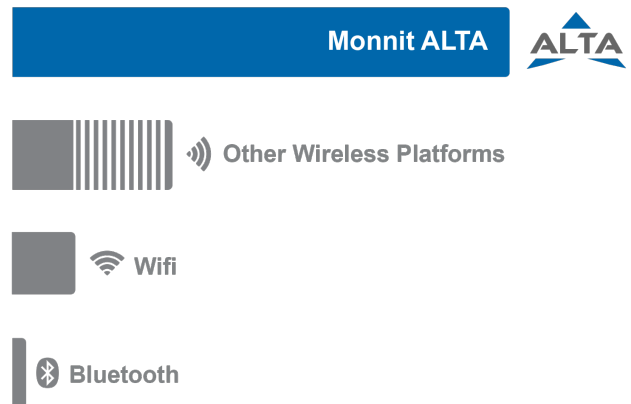

**Battery life is determined by sensor reporting frequency and other variables. Other power options are also available.

Wireless Range Comparison

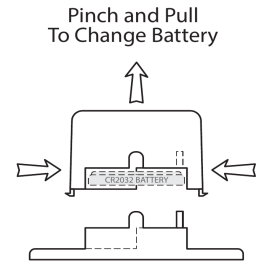
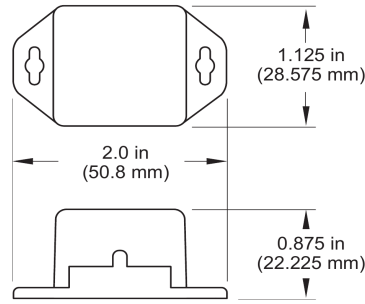



Wireless 200 VDC Voltage Meter (Coin Cell) | Technical Specifications

Supply voltage	2.0–3.6 VDC *
Current consumption	0.2 μ A (sleep mode), 0.7 μ A (RTC sleep), 570 μ A (MCU idle), 2.5 mA (MCU active), 5.5 mA (radio RX mode), 22.6 mA (radio TX mode)
Operating temperature range (board circuitry and coin cell)	-7°C to +60°C (20°F to +140°F)
Optimal battery temperature range (coin cell)	+10°C to +50°C (+50°F to +122°F)
Absolute Maximum Voltage	250 VDC
Accurate Range	0 to 200 VDC**
Accuracy	+/- (.1V + 1% of reading)
Calibrated Accuracy	+/- (.05V + 5% of reading)
Input Impedance	1.33 MOhm
Response Time	100 ms
Leaded wire specification	2 Wires, 1 ft. (12 in), Red (+), Black (-), 22 AWG (Custom lengths available upon request)
Integrated memory	Up to 3200 sensor messages
Wireless range	1,200+ ft non-line-of-sight
Security	Encrypt-RF® (256-bit key exchange and AES-128 CTR)
Weight	1.0 oz.
Certifications	<div style="display: flex; align-items: center; gap: 10px;">    Industry Canada </div> 900 MHz product; FCC ID: ZTL-G2SC1 and IC: 9794A-G2SC1. 868 and 433 MHz product tested and found to comply with: EN 300 220-2 V3.1.1 (2017-02), EN 300 220-2 V3.1.1 (2017-02) and EN 60950

* Circuit cannot withstand negative voltage. Please take care when installing batteries.



** If application exceeds 200 VDC the sensor will return a maximum reading of 200 V.

*** Operation mode must be specified at time of purchase.

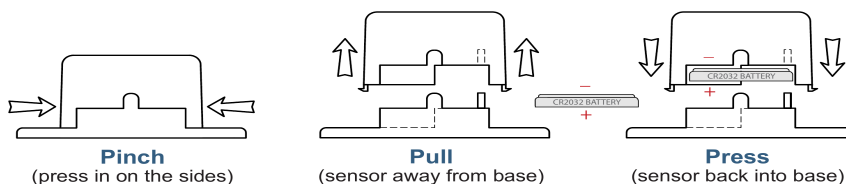
PinchPower™ Enclosure

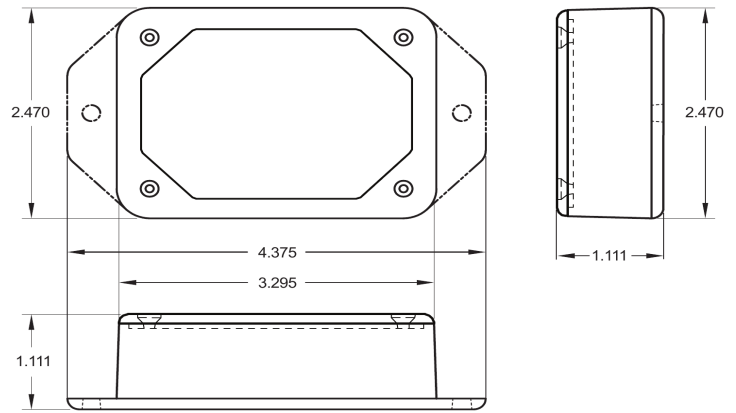



ALTA Wireless 200 VDC Voltage Meter (AA) Technical Specifications	
Supply voltage	2.0–3.6 VDC (3.0–3.6 VDC using power supply) *
Current consumption	0.2 μ A (sleep mode), 0.7 μ A (RTC sleep), 570 μ A (MCU idle), 2.5 mA (MCU active), 5.5 mA (radio RX mode), 22.6 mA (radio TX mode)
Operating temperature range (board circuitry and batteries)	-18°C to 55°C (0°F to 130°F) using alkaline -40°C to 85°C (-40°F to 185°F) using lithium **
Optimal battery temperature range (AA)	+10°C to +50°C (+50°F to +122°F)
Absolute Maximum Voltage	250 VDC
Accurate Range	0 to 200 VDC **
Accuracy	+/- (.1V + 1% of reading)
Calibrated Accuracy	+/- (.05V + 5% of reading)
Input Impedance	1.33 MOhm
Response Time	100 ms
Leaded wire specification	2 Wires, 1 ft. (12 in), Red (+), Black (-), 22 AWG (Custom lengths available upon request)
Integrated Memory	Up to 3200 sensor messages
Wireless range	1,200+ ft non-line-of-sight
Security	Encrypt-RF® (256-bit key exchange and AES-128 CTR)
Weight	4.0 oz.
Certifications	<div style="display: flex; align-items: center; gap: 10px;">    Industry Canada </div> 900 MHz product; FCC ID: ZTL-G2SC1 and IC: 9794A-G2SC1. 868 and 433 MHz product tested and found to comply with: EN 300 220-2 V3.1.1 (2017-02), EN 300 220-2 V3.1.1 (2017-02) and EN 60950

* Circuit cannot withstand negative voltage. Please take care when installing batteries.

** If application exceeds 200 VDC the sensor will return a maximum reading of 200 V.

*** Operation mode must be specified at time of purchase.



Power Options

Two replaceable 1.5V AA sized batteries are included with the standard model. A line-power version with battery backup is also available—allowing it to be powered by a standard 3.0–3.6V power supply and use the internal batteries if there is a power interruption.

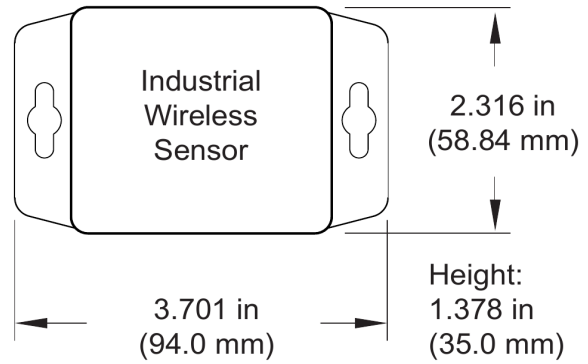
Power options must be selected at time of purchase as the internal hardware of the sensor must be changed to support the selected power requirements.



ALTA Industrial Wireless 200 VDC Voltage Meter | Technical Specifications

Supply voltage	2.0–3.8 VDC (3.0–3.8 VDC using power supply) *	
Current consumption	0.2 μ A (sleep mode), 0.7 μ A (RTC sleep), 570 μ A (MCU idle), 2.5 mA (MCU active), 5.5 mA (radio RX mode), 22.6 mA (radio TX mode)	
Operating temperature range (board circuitry and battery)	-40°C to +85°C (-40°F to +185°F)	
Included battery	Max temperature range	-40° to +85°C (-40° to +185°F)
	Capacity	1200 mAh
Absolute Maximum Voltage	250 VDC	
Accurate Range	0-200 VDC	
Accuracy	+/- (.1V + 1% of reading)	
Calibrated Accuracy	+/- (.5V + .5% of reading)	
Input Impedance	1.33 MOhm	
Response Time	100 ms	
Leaded wire specification	2 Wires, 1 ft. (12 in), Red (+), Black (-), 22 AWG (Custom lengths available upon request)	
Integrated memory	Up to 3200 sensor messages	
Wireless range	1,200+ ft non-line-of-sight	
Security	Encrypt-RF® (256-bit key exchange and AES-128 CTR)	
Weight	4.7 ounces	
Enclosure rating	NEMA 1, 2, 4, 4x, 12 and 13 rated, sealed and weather proof	
UL rating	UL Listed to UL508-4x specifications (File E194432)	
Certifications	   Industry Canada	900 MHz product; FCC ID: ZTL-G2SC1 and IC: 9794A-G2SC1. 868 and 433 MHz product tested and found to comply with: EN 300 220-2 V3.1.1 (2017-02), EN 300 220-2 V3.1.1 (2017-02) and EN 60950

* Circuit cannot withstand negative voltage. Please take care when installing batteries.

** Operation mode must be specified at time of purchase.

*** If application exceeds 200 VDC the sensor will return a maximum reading of 200 V.

Proper Installation

If the sensor is not connected to the power source properly, it will appear that the sensor is broken. Please follow this wiring diagram to ensure proper performance and detection.

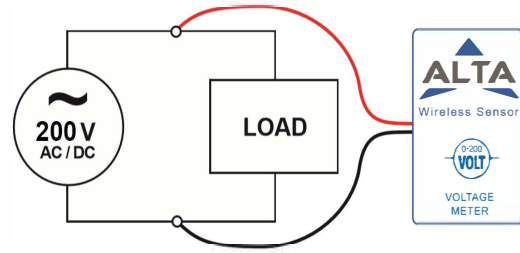

Commercial Grade Sensors

Monnit commercial grade sensors are designed for applications in ordinary environments (normal room temperature, humidity and atmospheric pressure). Do not use these sensors under the following conditions as these factors can deteriorate the product characteristics and cause failures and burnout.

- Corrosive gas or deoxidizing gas: chlorine gas, hydrogen sulfide gas, ammonia gas, sulfuric acid gas, nitric oxides gas, etc.
- Volatile or flammable gas
- Dusty conditions
- Low-pressure or high-pressure environments
- Wet or excessively humid locations
- Places with salt water, oils chemical liquids or organic solvents
- Where there are excessively strong vibrations
- Other places where similar hazardous conditions exist

Use these products within the specified temperature range. Higher temperature may cause deterioration of the characteristics or the material quality.

Industrial Grade Sensors | Type 1, 2, 4, 4X, 12 and 13 NEMA Rated Enclosure

Monnit's Industrial sensors are enclosed in reliable, weatherproof NEMA-rated enclosures. Our NEMA-rated enclosures are constructed for both indoor or outdoor use and protect the sensor circuitry against the ingress of solid foreign objects like dust as well as the damaging effects of water (rain, sleet, snow, splashing water, and hose-directed water).

- Safe from falling dirt
- Protects against wind-blown dust
- Protects against rain, sleet, snow, splashing water, and hose-directed water
- Increased level of corrosion resistance
- Will remain undamaged by ice formation on the enclosure