

Adding a Sensor Node to the HOBOnet® Wireless Sensor Network

Important: Keep the sensor node near the station while completing these steps.

If you are setting up a new station, follow the instructions in the station quick start guide before setting up this sensor node (go to www.onsetcomp.com/resources/documentation/24380-man-rx2105-rx2106-qsg for RX2105 and RX2106 stations or www.onsetcomp.com/resources/documentation/18254-man-qsg-rx3000 for RX3000 stations).

1

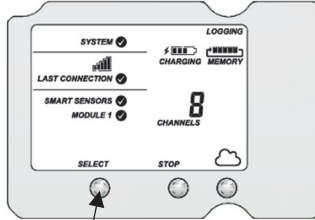

Press the Select button on the station to switch to the module with the manager (module 2 on RX2105 or RX2106 stations).

2

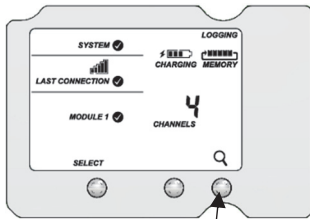

Press the Search button. The magnifying glass icon blinks while the station is in search mode waiting for sensor nodes to join the network.

3

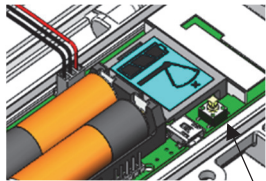

Open the door and install the rechargeable batteries. Press this button on the sensor node for 3 seconds.

4

Watch the sensor node LCD during the process of joining the network:

a.



This signal strength icon blinks while searching for a network.

b.



Once a network is found, the icon stops blinking and the bars cycle from left to right.

c.



This network connection "x" icon blinks while the sensor node completes the registration process, which may take up to five minutes.

d.



Once the sensor node has finished joining the network, the "x" icon is no longer displays and the channel count on the station LCD increases by two (one for rainfall and one for the sensor node battery).

5

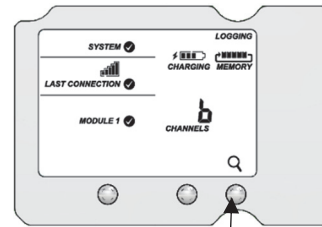

Press the Search button on the station again to stop the search for sensor nodes.

6



Go to www.hobolink.com to monitor sensor node status and health. See the HOBOLink Help for details.

Installing the Bracket and Sensor Node

1

Orient the bracket so the text TOP is facing upwards.

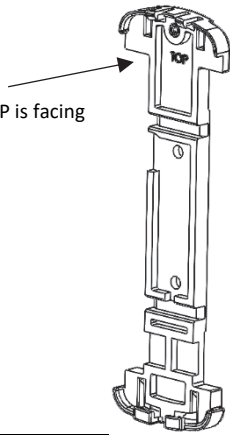

2

To install the bracket onto a wall, use the two long screws included in the package. Screw the bracket to a wall using the two holes on the mid-section of the bracket.

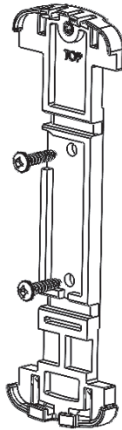

3

To install the bracket onto a pole, slip a cable tie through each of the channels on the bracket and fasten the tie around the pole.

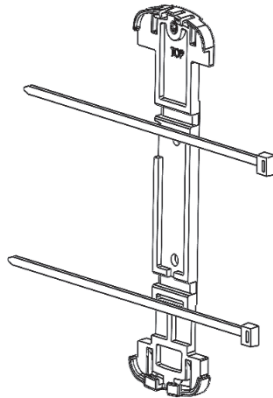

4

Insert the bottom of the sensor node into the retaining clips on the bottom of the bracket then press the top of the sensor node into the clips at the top of the bracket.

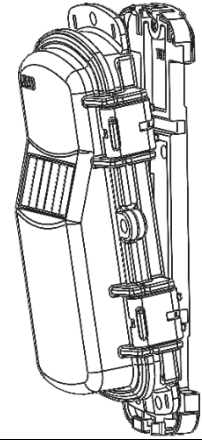

5

Use the short screw included in the package to fasten the sensor node to the bracket.

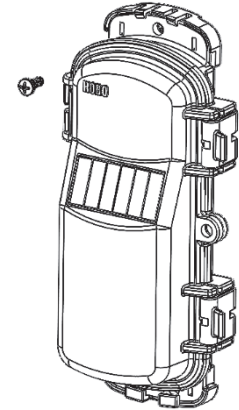

6

Close the sensor node and use a padlock to keep it secure.

Note: Ensure that the node seal is clean from foreign debris.

Mounting and Positioning the Sensor Node

- Position the sensor node towards the sun, making sure the solar panel is oriented so that it receives optimal sunlight throughout each season. It may be necessary to periodically adjust the sensor node position as the path of the sunlight changes throughout the year or if tree and leaf growth alters the amount of sunlight reaching the solar panel.
 - Make sure the sensor node is mounted a minimum of 1.8 m (6 feet) from the ground or vegetation to help maximize distance and signal strength.
 - Consider using plastic poles such as PVC to mount the sensor node as certain types of metal could decrease the signal strength.
 - Place the sensor node so there is full line of sight with the next sensor node. Use a repeater if there is an obstruction between sensor nodes.
 - There should not be more than five sensor nodes in any direction from a repeater or the manager. Data from sensor nodes travels or “hops” across the network and may not reach the station if the sensor node is more than five hops away.
-

Sensor Node Mounting Guidelines

- Mount the rain gauge sensor so that it is level using the built-in bubble level attached to the base.
 - Be sure there is an unobstructed path for water runoff from the drain screens.
 - The sensor contains a magnet-operated switch that may not operate correctly if you mount the rain gauge on or near any object that is attracted to a magnet.
 - Exposure to winds can reduce the measured rainfall amounts. Mount the sensor where there are no obstructions of rainfall at low angles (such as trees, houses, fences) and as low as possible out of the wind.
 - If installing the sensor on a sheet metal roof, insulate the unit by making a platform out of wood. Mount the base of the rain gauge at least 4 cm (1 inch) away from any steel or iron surface and make sure the reed switch is at least 4 cm (1 inch) away from any steel or iron objects (e.g. nails).
 - For the most accurate rainfall measurements, it is recommended that you mount the sensor upslope, about 3 meters (10 feet) away from the tripod, on a 1.5 meter high mounting pole (M-MPB). Alternatively, you can mount the sensor on the tripod mast.
 - Tall objects can interfere with accurate rain measurements. It is recommended that you place the rain bucket away from the obstruction by a distance greater than three times the height of the obstruction. If that is not possible, raise the rain bucket as high as possible to avoid shedding.
 - Avoid splashing and puddles. Be sure the gauge is high enough above any surface that rain will not splash into the top of the collector.
 - Vibration can significantly degrade accuracy of the tipping bucket mechanism. In windy locations make sure that the bucket will be vibration-free. Consider using guy wires to secure a pole or tower-mounted bucket.
-

Assembling and Mounting the Sensor Node

1. Remove the cone from the base by rotating the base until the latches on the cone line up with the latch openings in the base, then lift the cone away from the base.
2. The tipping assembly on the base has been secured to avoid possible damage to the assembly. Remove the rubber band to release the tipping assembly.
3. While holding the mounting base against the pole, place the two ends of a U-bolt around the pole and through the two holes in the base.

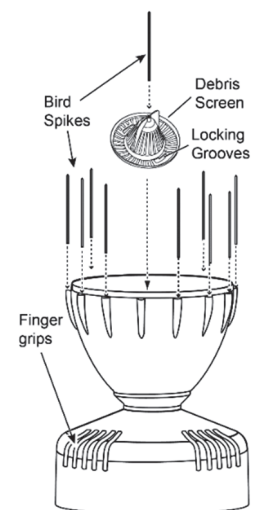
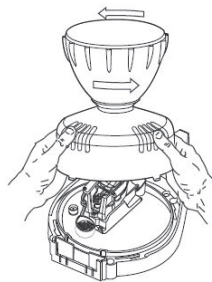

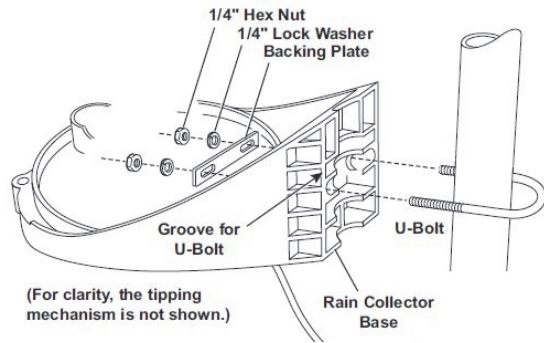

4. Slide the metal backing plate over the bolt ends as they stick out toward the rain collector cone. Secure the backing plate with a washer, a lock washer, and a hex nut on each of the bolt ends. Adjust the height of the rain collector, then tighten the nuts.
5. To use bird spikes, insert one spike into each socket around the rim of the cone. The sockets are tapered; push firmly or

tap lightly with a hammer for a more secure fit. Be careful; bird spikes may be sharp.

6. Place the cone back onto the base by putting the latches on the cone into the latch openings in the base and rotating the cone clockwise until the latches “lock” into place.
7. Place the debris screen, pointed end up, into the cone. The screen prevents large bits of debris from blocking the funnel hole. If bird nesting is a problem, you can place a spike in the hole on top of the debris screen. Note that using a bird spike in the debris screen may make the screen more likely to be blown over or out in a high wind gust.



For specifications, complete mounting guidelines, and other details about this sensor node, refer to the full product manual. Scan the code at the left or go to: www.onsetcomp.com/resources/documentation/22244-rxw-rgx-manual