



RXW Pulse Input Sensor

Models:

- RXW-UCC-900 and RXW-UCD-900 (US)
- RXW-UCC-868 and RXW-UCD-868 (Europe)
- RXW-UCC-921 and RXW-UCD-921 (Taiwan)
- RXW-UCC-922 and RXW-UCD-922 (Australia/NZ)

Included Items:





- Two wire nuts

This sensor measures pulses and is designed to work with the HOBOnet® (HOBOnet® RX) Wireless Sensor Network in which data is transmitted wirelessly from the sensor mote across the network to the station and then uploaded to HOBOLink® web-based software. With HOBOLink®, you can monitor sensor readings, view graphs, set up alarms, download data, and more.

Specifications

Sensor	RXW-UCC-xxx For Electronic Switches	RXW-UCD-xxx For Contact Closures
Measurement Input Frequency	120 Hz (120 pulses per second)	2 Hz (2 pulses per second)
Measurement Range	0–65,533 pulses per logging interval	
Resolution	1 pulse	
Lockout Time	45 μs ±10%	327 ms ±10%
Recommended Input Type	Electronic solid state switch closure or CMOS-level digital output (example: FET, opto-FET or open collector)	Mechanical contact closure (example: reed switch in a tipping-bucket rain gauge)
Preferred Switch State*	Active low input	Normally open
Edge Detection	Falling edge, Schmitt Trigger buffer (logic levels: low ≤0.6 V, high ≥2.7 V)	
Minimum Pulse Width	1 ms	
Input/Output Impedance	100 KΩ	
Open Circuit Input Voltage	3.3 V	
Maximum Input Voltage	3.6 V	
User Connection	24 AWG wires, 2 leads: white(+), black(-)	
Wireless Mote		
Operating Temperature Range	-25° to 60°C (-13° to 140°F) with rechargeable batteries -40 to 70°C (-40 to 158°F) with lithium batteries	
Radio Power	12.6 mW (+11 dBm) non-adjustable	
Transmission Range	Reliable connection to 457.2 m (1,500 ft) line of sight at 1.8 m (6 ft) high Reliable connection to 609.6 m (2,000 ft) line of sight at 3 m (10 ft) high	
Wireless Data Standard	IEEE 802.15.4	
Radio Operating Frequencies	RXW-UCC-900 and RXW-UCD-900: 904–924 MHz RXW-UCC-868 and RXW-UCD-868: 866.5 MHz RXW-UCC-921 and RXW-UCD-921: 921 MHz RXW-UCC-922 and RXW-UCD-922: 916–924 MHz	
Modulation Employed	OQPSK (Offset Quadrature Phase Shift Keying)	
Data Rate	Up to 250 kbps, non-adjustable	
Duty Cycle	<1%	
Maximum Number of Motes	Up to 50 wireless sensors or 336 data channels per one HOBOnet RX station	
Logging Rate	1 minute to 18 hours	
Number of Data Channels	2	
Battery Type/Power Source	Two AA 1.2 V rechargeable NiMH batteries powered by built-in solar panel or two AA 1.5 V lithium batteries for operating conditions of -40° to 70°C (-40° to 158°F)	
Battery Life	With NiMH batteries: Typical 3–5 years when operated in the temperature range -20° to 40°C (-4°F to 104°F) and positioned toward the sun (see <i>Deployment and Mounting</i>), operation outside this range will reduce the battery service life With lithium batteries: 1 year, typical use	
Memory	16 MB	

Specifications (continued)

Dimensions	Cable length: 6.5 m (21.3 ft.) Mote: 16.2 x 8.59 x 4.14 cm (6.38 x 3.38 x 1.63 inches)
Weight	Cable: 250 g (9 oz) Mote: 223 g (7.87 oz)
Materials	Mote: PCPBT, silicone rubber seal
Environmental Rating	Mote: IP67, NEMA 6
Compliance Marks	 RXW-UCC-900 and RXW-UCD-900: See last page  RXW-UCC-868 and RXW-UCD-868: The CE Marking identifies this product as complying with all relevant directives in the European Union (EU).  RXW-UCC-921 and RXW-UCD-921: See last page  RXW-UCC-922 and RXW-UCD-922: See last page

- For maximum battery life, the pulse input sensors should be used with their preferred switch type. The sensors will work with active high inputs (RXW-UCC-xxx) and normally closed switches (RXW-UCD-xxx), but battery life will not be optimized.

Mote Components and Operation

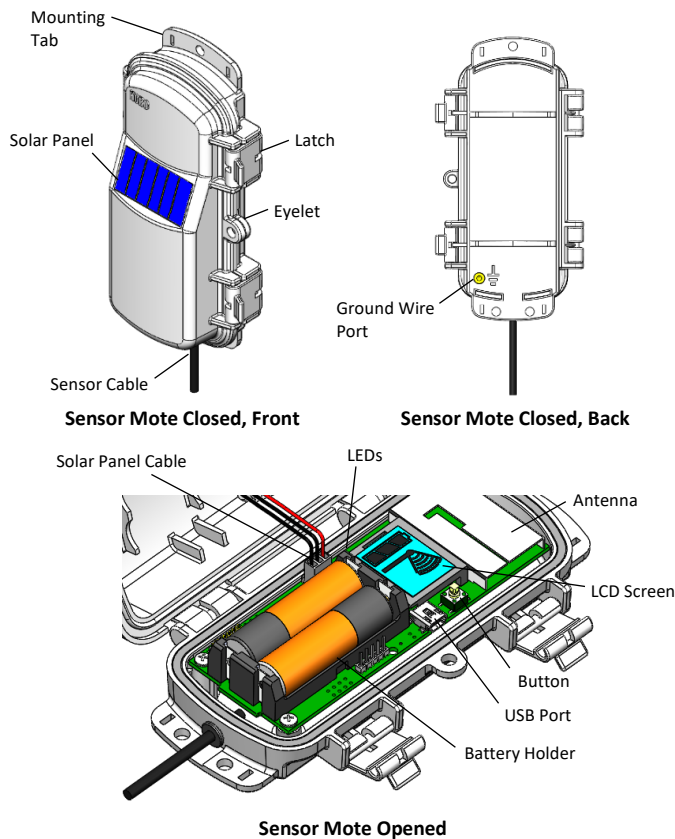

Ground Wire Port: Use this port to connect a ground wire (see *Deploying and Mounting*).

Antenna: This is the built-in antenna for the radio communications across the HOBOnet Wireless Sensor Network.

LEDs: There are two LEDs to the left of the LCD screen. The green LED blinks during the process of joining a network, blinking quickly while the mote searches for a network and then slowly as the mote registers with the network. Once the network registration process is complete, the blue LED blinks at 4 seconds to indicate normal operation. If the mote is not currently part of a network, the blue LED will be off. If the blue LED is on and not blinking, there is a problem with the mote. Contact Onset Technical Support.

Solar Panel Cable: This cable connects the built-in solar panel to the mote circuitry.

Battery Holder: The location where the batteries are installed as shown (see *Battery Information*).

USB Port: Use this port to connect to the mote to a computer via USB cable if you need to update the firmware (see *Updating Mote Firmware*).

Button: Push this button for 1 second to illuminate the LCD or 3 seconds for the mote to search for a HOBOnet Wireless Sensor Network to join (see *Adding the Mote to the HOBOnet Wireless Sensor Network*).

LCD Screen: The mote is equipped with an LCD screen that displays details about the current status. This example shows all symbols illuminated on the LCD screen followed by definitions of each symbol in the table.

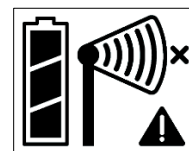

Mounting Tab: Use the tabs at the top and bottom of the mote to mount it (see *Deploying and Mounting*).





Solar Panel: Position the solar panel towards the sun to charge the mote batteries (see *Deploying and Mounting*).

Sensor Cable: This is the cable that connects the mote to the sensor.

Eyelet: Use this eyelet to attach a 3/16 inch padlock to the mote for security.

Latch: Use the two latches to open and close the mote door.

LCD Symbol	Description
	The battery indicator shows the approximate battery charge remaining.

LCD Symbol	Description
	This is a signal strength indicator. The more bars, the stronger the signal between motes. If there is no x icon next to the signal strength indicator, then the mote is part of a HOBOnet Wireless Sensor Network.
	An empty signal strength icon plus the x icon indicates that the mote is not currently part of a network. See <i>Adding the Mote to the HOBOnet Wireless Sensor Network</i> for details on how to add a mote to the network.
	When the mote is in the process of joining a network, the signal strength icon will blink and then the bars in the icon will cycle from left to right. The x icon will blink during the last step in the network registration process (see <i>Adding the Mote to the HOBOnet Wireless Sensor Network</i> for details).
	This indicates a problem with the sensor itself (the mote is operational). Check the sensor and make any adjustments to it as needed. Contact Onset Technical Support if the problem persists.

Adding the Mote to the HOBOnet Wireless Sensor Network

The mote must join a HOBOnet Wireless Sensor Network before it can begin measuring temperature and transmitting data. This requires accessing the station and the mote at the same time so it is recommended that you complete these steps before deploying the mote.

Important: If you are setting up a new station, follow the instructions in the station quick start before setting up this mote (go to www.onsetcomp.com/support/manuals/24380-man-rx2105-rx2106-qsg for RX2105 and RX2106 stations or go to www.onsetcomp.com/support/manuals/18254-MAN-QSG-RX3000 for RX3000 stations).

To add a mote to the network:

1. If the LCD is blank on the station, press any button to wake it up.
2. Press the Select button once (which shows the number of smart sensors installed) and then press it again to switch to the module with the manager (module 2 on RX2105 or RX2106 stations).

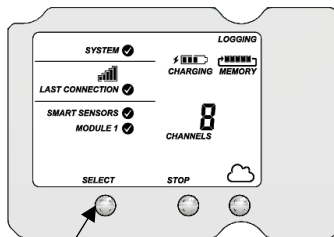

Press this button to view the module

3. Press the Search button (the magnifying glass). The magnifying glass icon will blink while the station is in search mode.

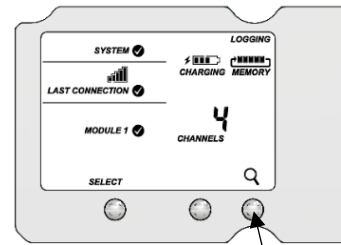

Press this button so the station is ready to have motes join the network

4. Open the mote door and install the batteries if you have not already done so.
5. Press the button on the mote for 3 seconds. The signal strength icon will flash and then cycle.

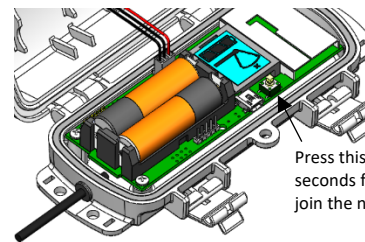

Press this button for 3 seconds for the mote to join the network

6. Watch the LCD on the mote.

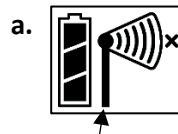

a.

This signal strength icon blinks while searching for a network.



b.

Once a network is found, the icon will stop flashing and the bars will cycle from left to right.



c.

This network connection "x" icon blinks while the mote completes the registration process, which may take up to five minutes.



d.

Once the mote has finished joining the network, the "x" icon is removed and the channel count on the station LCD increases by two (one for the pulse input sensor and one for the mote battery).

This process may take up to five minutes. The green LED blinks quickly while the mote searches for a network to join and then blinks slowly while it completes the network registration. Once the mote has finished joining the network, the green LED turns off and the blue LED then blinks indefinitely while the mote is part of the network.

Note: If the mote cannot find the network or has trouble remaining connected during this process, make sure the mote is in a vertical, upright position and within range of the station.

- Press the Search button (the magnifying glass) on the station to stop searching for motes.

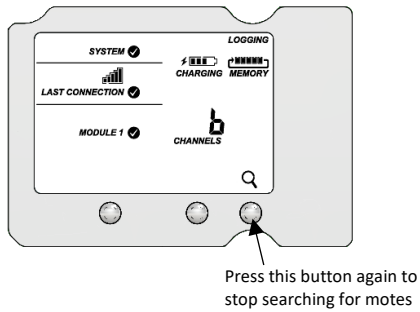

If you added more than one more mote to the network, then the total channel count on the station LCD for the manager module will represent all measurement channels plus a battery channel for each mote in the network.

Sensor measurements will be recorded at the logging interval specified in HOBOLink, transmitted to the station, and uploaded to HOBOLink at the next connection interval (readout). Use HOBOLink to monitor mote status and health. If a mote is temporarily offline, any logged data is saved until it is back online. In addition, if a mote is offline for 30 minutes, the station will automatically connect to HOBOLink and report the mote as missing. Once the mote is back online, any logged data will be uploaded the next time the station connects to HOBOLink.

See the HOBOLink Help for details on how to change the logging and connection intervals, view data, check mote status, add the mote to a map, and more.

Input Connections

The pulse input sensor has two input connections. The white wire (+) is powered at 3.3 V through a 100 KΩ resistor. This power is supplied from the mote battery. The black wire (-) is connected to the mote's ground connection. The input cable can be connected directly to screw terminals on the sensor or to sensor cables with the included wire nuts.

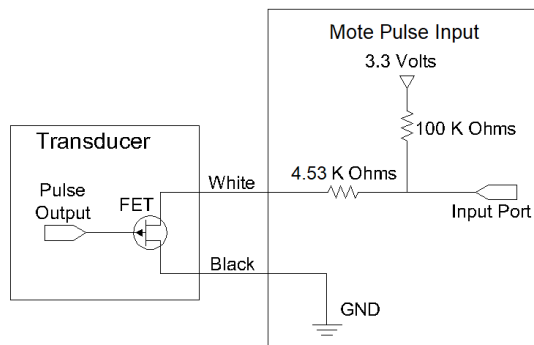

Wiring for RXW-UCC Pulse Input

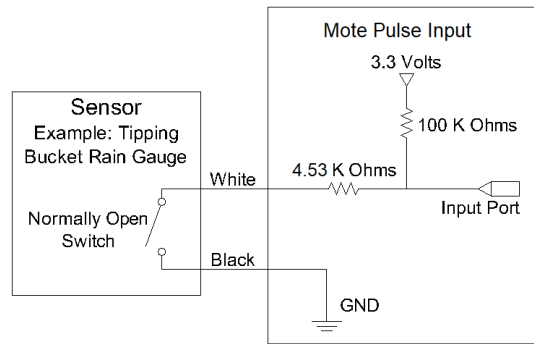

Wiring for RXW-UCD Pulse Input

Connection Using Wire Nuts

Important: If using wire nuts, make sure the connection is protected from the elements.

- Strip 1 cm (0.39 in.) of insulation from the end of wires, taking care not to nick the metal conductors.
- Twist the stripped wires together clockwise and then screw on the wire nut clockwise.
- Check the connection by gently pulling on the wires to verify a solid mechanical connection. Always strain-relief the connection to make sure that the connection is not broken by being jerked or repeatedly worked back and forth.

Deployment and Mounting

Mounting and Positioning the Mote

- Mount the mote to a mast or pipe using cable ties or affix the mote to a wooden post or flat surface with screws. Insert the cable ties or screws through the holes on the mounting tabs.
- Consider using plastic poles such as PVC to mount the mote as certain types of metal could decrease signal strength.
- Make sure the mote remains in a vertical position once it is placed in its deployment location for optimal network communications.
- Make sure the mote door is closed, with both latches fully locked to ensure a watertight seal.
- Consider using a 3/16 inch padlock to restrict access to the mote. With the mote door closed, hook a padlock through the eyelet on the right side of the door and lock it.
- Position the mote towards the sun, making sure the solar panel is oriented so that it receives optimal sunlight throughout each season. It may be necessary to periodically adjust the mote position as the path of the sunlight changes throughout the year or if tree and leaf growth alters the amount of sunlight reaching the solar panel.
- Make sure the mote is mounted a minimum of 1.8 m (6 ft) from the ground or vegetation to help maximize distance and signal strength.
- Place the mote so there is full line of sight with the next mote. If there is an obstruction between two sensor

motes or between the sensor mote and the manager, then use a repeater mounted on the obstruction. For example, if there is a hill between the sensor mote and the manager, place a repeater at the top of the hill between the sensor mote and the manager.

- There should not be more than five motes in any direction at their maximum transmission range from the manager. Data logged by a wireless sensor must travel or “hop” across the wireless network from one mote to the next until it ultimately reaches the manager connected to the station. To make sure the data can successfully travel across the network, the mote should not be more than five hops away from the manager.
- The HOBONet Wireless Sensor Network can support up to 50 wireless sensors or 336 data channels per one HOBONet RX station.
- Use a #4-40 screw to attach a ground wire to the port on the back of the mote if you are deploying the mote in a location where lightning is a concern.

RXW-UCC Pulse Input Sensor Deployment Guidelines

- The RXW-UCC pulse input sensor is designed for devices with a normally open solid-state switch, FET switch, or open collector, with a maximum pulse frequency of 120 Hz. This input sensor will not work with sensors that have mechanical switch outputs, AC outputs, or outputs that must be de-bounced as described in the RXW-UCD guidelines.

RXW-UCD Pulse Input Sensor Deployment Guidelines

- The RXW-UCD pulse input sensor is designed to work with tipping-bucket rain gauges and other devices with normally open, mechanical contact closure, switched outputs with a maximum pulse frequency of 2 Hz. This sensor has a pre-set lockout time of 327 ms and is designed to work with signals that must be de-bounced to be accurately measured. “Bounce” is a phenomenon where a single pulse may contain several false pulses or bounces. De-bouncing a signal is typically required when measuring signals from mechanical switches, contact closures, and reed switches.
- The lockout time prevents bounce-induced false pulses from being counted as separate switch closures. If your gauge has a counter display and battery, disconnect them and connect the pulse input sensor in their place. In most cases, the black and white wires can be connected directly to the relay output. (When connecting to relay or switch contacts, polarity does not matter.)

General Pulse Input Sensor Deployment Guidelines

- Coil and secure excess cable with cable ties.
- If cable is on the ground, use a conduit to protect against such things as animals, lawn mowers, and exposure to chemicals.
- When making a connection to a third-party sensor, take time to make sure that the connection is reliable and protected from rain, dirt, and direct exposure to the elements. Refer to the manufacturer’s product

documentation for additional information on system configuration.

- Refer to the station manual and Tripod Setup Guide at www.onsetcomp.com/support/manuals for more information regarding setting up stations.

Maintenance

The mote is designed for outdoor use, but should be inspected periodically. When inspecting the mote, do the following:

- Verify the mote is free of visible damage or cracks.
- Make sure the mote is clean. Wipe off any dust or grime with a damp cloth.
- Wipe off any water before opening the mote.
- Make sure the interior seal is intact and the latches are fully locked when the mote door is closed.



Verifying Functionality

To verify proper operation of the pulse input sensor, make sure the station is logging with a fast logging interval (for example 1 minute) and perform a test that simulates pulses so that you can compare it to data logged. For example with the RXW-UCD pulse input sensor, enter a known number of pulses (for example, if using a tipping-bucket rain gauge, tip the bucket several times). Connect to HOBOLink and export the logged data to verify that the number of pulses is correct.

If the pulse input sensor is not capturing pulses, check the connections to the sensor and verify the device being measured is functioning normally.

Updating Mote Firmware

If a new firmware version is available for the mote, use HOBOLink to download the file to your computer.

1. In HOBOLink, go to Devices, RX Devices, and click your station name.
2. On the station page, click Overview and scroll down to Device Information.
3. Click the Wireless tab. This icon  appears next to the mote if there is a new version of firmware available.
4. Click the firmware  upgrade link. Click Download and save the firmware .bin file to your computer.
5. Connect the mote to the computer with a USB cable (open the mote door and use the USB port to the right of the LCD). The blue LED is illuminated while connected.
6. The mote appears as a new storage device in the computer’s file storage manager. Copy the downloaded firmware file to the new storage device (the mote). The blue LED will blink slowly while the file is copying.
7. After the file is copied to the mote, the LED will stop blinking and remain a steady blue. Eject the storage device from the computer and disconnect the cable from the mote. The firmware installation process will begin automatically on the mote. The blue LED will blink rapidly while the firmware is installed. Once the firmware installation is complete, the LCD symbols return and the mote will automatically rejoin the network.

Notes:

- Mac® users: A message may appear indicating the disk has not ejected properly when disconnecting the mote from the computer. The mote is operational and you can ignore the message.
- If the blue LED turns off abruptly while copying the file or installing the firmware, a problem has occurred. Contact Onset Technical Support for help.

Battery Information

The mote uses two 1.2 V rechargeable NiMH batteries, charged by the built-in solar panel. The quality and quantity of solar light can affect whether the battery is sufficiently charged to last through the night and cloudy periods. Make sure the mote is placed in a location that will receive several hours of sunlight each day. If the mote does not receive enough sunlight to recharge the batteries, the battery life is estimated at 3–4 months. When batteries are regularly recharged, expected battery life is estimated at 3–5 years. Battery life varies based on the ambient temperature where the mote is deployed, the logging interval, the number of tripped alarms, and other factors. Deployments in extremely cold or hot temperatures can impact battery life. Estimates are not guaranteed due to uncertainties in initial battery conditions and operating environment.

The pulse input sensor consumes about 1 μA of current with the input high (switch open) and about 33 μA with the input low (switch closed). For maximum battery life, use the pulse input sensor with normally open switches or with transducers that are off (circuit open) for 90% of the time or longer.

Mote operation will stop when battery voltage drops to 1.8 V. Mote operation will return if the battery recharges to 2.3 V. If the batteries are unable to be recharged, replace them with fresh rechargeable batteries. **Note:** if you install used rechargeable batteries that together are less than 2.3 V, the mote will not resume operation.

To replace rechargeable batteries:

1. Open the mote door.
2. Remove the old batteries and install fresh ones observing polarity.
3. Make sure the solar panel cable is plugged in.

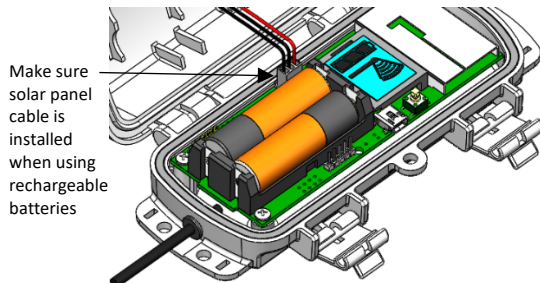

The mote contacts the network once the new batteries are installed. The green LED blinks during this process while the bars in the signal strength indicator on the LCD cycle from left to right and then the x icon blinks. Once this process is

complete, the x icon is removed, the green LED stops blinking, and the blue LED begins blinking instead.

Lithium Batteries

You can use two 1.5 V lithium batteries (HWSB-LI) for operation at the extreme ends of the mote operating range. Lithium battery life is estimated at 1 year, but varies based on the ambient temperature where the mote is deployed, the logging interval, the number of tripped alarms, and other factors. Estimates are not guaranteed due to uncertainties in initial battery conditions and operating environment. When using lithium batteries, you must disconnect the solar panel cable because the batteries will not be recharged.

To install lithium batteries:

1. Open the mote door.
2. Remove any old batteries and install the new ones observing polarity.
3. Push in the side tab of the solar panel cable connector and pull the connector out of the cable port.
4. Place the connector in the slot on the inside of the mote door. Make sure the solar panel cables are tucked inside the door so that they do not interfere with the interior seal when the mote is closed.

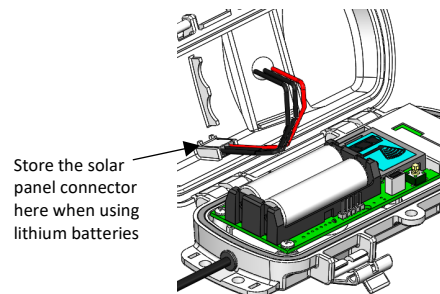

The mote contacts the network once the new batteries are installed. The green LED blinks quickly while the mote searches for a network to join and then blinks slowly while it completes the network registration. Once the mote has finished joining the network, the green LED turns off and the blue LED then blinks indefinitely while the mote is part of the network.

⚠ WARNING: Do not cut open, incinerate, heat above 85°C (185°F), or recharge the lithium batteries. The batteries may explode if the mote is exposed to extreme heat or conditions that could damage or destroy the battery cases. Do not mix battery types, either by chemistry or age; batteries may rupture or explode. Do not dispose of the logger or batteries in fire. Do not expose the contents of the batteries to water. Dispose of the batteries according to local regulations for lithium batteries.

Federal Communication Commission Interference Statement

This equipment has been tested and found to comply with the limits for a Class B digital device, pursuant to Part 15 of the FCC Rules. These limits are designed to provide reasonable protection against harmful interference in a residential installation. This equipment generates uses and can radiate radio frequency energy and, if not installed and used in accordance with the instructions, may cause harmful interference to radio communications. However, there is no guarantee that interference will not occur in a particular installation. If this equipment does cause harmful interference to radio or television reception, which can be determined by turning the equipment off and on, the user is encouraged to try to correct the interference by one of the following measures:

- Reorient or relocate the receiving antenna
- Increase the separation between the equipment and receiver
- Connect the equipment into an outlet on a circuit different from that to which the receiver is connected
- Consult the dealer or an experienced radio/TV technician for help

This device complies with Part 15 of the FCC Rules. Operation is subject to the following two conditions: (1) This device may not cause harmful interference, and (2) this device must accept any interference received, including interference that may cause undesired operation.

FCC Caution: Any changes or modifications not expressly approved by the party responsible for compliance could void the user's authority to operate this equipment.

Industry Canada Statements

This device complies with Industry Canada license-exempt RSS standard(s). Operation is subject to the following two conditions: (1) this device may not cause interference, and (2) this device must accept any interference, including interference that may cause undesired operation of the device.

Avis de conformité pour l'Industrie Canada

Le présent appareil est conforme aux CNR d'Industrie Canada applicables aux appareils radio exempts de licence. L'exploitation est autorisée aux deux conditions suivantes : (1) l'appareil ne doit pas produire de brouillage, et (2) l'appareil doit accepter tout brouillage radioélectrique subi, même si le brouillage est susceptible d'en compromettre le fonctionnement.

To comply with FCC and Industry Canada RF radiation exposure limits for general population, the logger must be installed to provide a separation distance of at least 20cm from all persons and must not be co-located or operating in conjunction with any other antenna or transmitter.

NCC Statement

經型式認證合格之低功率射頻電機，非經許可，公司、商號或使用者均不得擅自變更頻率、加大功率或變更原設計之特性及功能。

低功率射頻電機之使用不得影響飛航安全及干擾合法通信；經發現有干擾現象時，應立即停用，並改善至無干擾時方得繼續使用。前項合法通信，指依電信法規定作業之無線電通信。低功率射頻電機須忍受合法通信或工業、科學及醫療用電波輻射性電機設備之干擾。

Translation:

Article 12

Without permission granted by the NCC, any company, enterprise, or user is not allowed to change frequency, enhance transmitting power or alter original characteristic as well as performance to an approved low power radio-frequency device.

Article 14

The low power radio-frequency devices shall not influence aircraft security and interfere with legal communications. If found, the user shall cease operating immediately until no interference is achieved. The said legal communications means radio communications is operated in compliance with the Telecommunications Act. The low power radio-frequency devices must be susceptible with the interference from legal communications or ISM radio wave radiated devices.