



CO2D 51
with extra 100 mm length
duct probe EDP 100



CO2D 51 MDR2B
with extra 100 mm length
duct probe EDP 100

Application

- Indoor Ventilation Control
- CO₂ monitoring in
offices, conference rooms, cinemas/theatre halls,
exhibition halls, restaurants, shopping malls etc.

Features

- Maintenance free NDIR sensor
- Measuring ranges
400-2.000 ppm
0-2.000 ppm
0-5.000 ppm
0-10.000 ppm
selectable ranges with DIP switch
On request 0-1.000 ppm
- Output(s)
0-10 Vdc, 2-10 Vdc, 4-20 ma, 0-5 Vdc or 1-5 Vdc
(One CO₂ output and Two CO₂ outputs available)
- Estimated operating life 15 years
- ABC – Automatic Baseline Calculation
- Accuracy 70 ppm +3 % reading
- Power supply 24 Vac/dc
- IP65 protection for both enclosure and probe
- Standard probe length 100 mm
Duct probe length can be extended to 200 mm with
EDP 100 (100 mm + 100 mm = 200 mm)

Options

- Modbus RS485 communication
- LCD Display
- 1 x relay output , can be set individually
- 2 x relay outputs, can be set individually
- Buzzer

See ordering codes and technical data
on next page for more detailed information

Ordering codes

Mounting type	Output 1 CO ₂	Output 2 CO ₂	"Options"	Advanced Options
CO2D = Duct	0 = no output 1 = 0-10 Vdc 2 = 2-10 Vdc 3 = 0-5 Vdc 4 = 1-5 Vdc 5 = 4-20 mA	0 = no output 1 = 0-10 Vdc 2 = 2-10 Vdc 3 = 0-5 Vdc 4 = 1-5 Vdc 5 = 4-20 mA	M = Modbus RS485 D = LCD display R1 = Relay x 1 R2 = Relays x 2 B = Buzzer E = 1.000 ppm	P = PID out T = RTC L = Datalogger

Ordering examples

Type no.	Description
CO2D 51	Duct Carbon Dioxide (CO ₂) transmitter, Two CO ₂ outputs, Output 1: 4-20 mA and Output 2: 0-10 Vdc
CO2D 51 M	Duct Carbon Dioxide (CO ₂) transmitter, Two CO ₂ outputs, Output 1: 4-20 mA and Output 2: 0-10 Vdc Modbus RS485 communication
CO2D 51 MDR2B	Duct Carbon Dioxide (CO ₂) transmitter, Two CO ₂ outputs, Output 1: 4-20 mA and Output 2: 0-10 Vdc Modbus RS485 communication, LCD Display, 2 x relay outputs and Buzzer
EDP 100	Extra Duct Probe, length 100 mm x diameter 30 mm Standard duct probe length is 100 mm. Duct probe length can be extended to 200 mm with EDP 100 (100 mm + 100 mm = 200 mm)

Notes:

Relay and Buzzer options should be ordered with LCD option for installer to change the set values and relay actions anytime. For advanced options and special application contact us on info@vcp.se

On request:

Temperature and Humidity option

Technical data





Electrical	Power Supply	24 Vac (± %5), 50-60 Hz ¹⁾ 15-35 Vdc
	Power Consumption	< 2.5 W
Outputs	Current Output	4-20 mA, maximum 500 Ω
	Voltage Output	0-10 Vdc, minimum 1.000 Ω
	Relay Output	0-5 Vdc, minimum 1.000 Ω max. rating 1A @ 220 Vac
Accuracy	CO2	70 ppm + 3% reading
CO2 sensor	Sensing Element	NDIR
	ABC period	8 days
	t90	< 120 sec.
	Sensor life time	> 15 years expected
	Resolution	1 ppm
	Operating Temperature	0 to +50°C
	Operating Humidity	0 to +85% % rH
Operating Pressure	800 to 1.200 mbar	
General data	Media	Air or non-aggressive gasses
	Storage temperature	-20 to +50°C
Ranges	CO2	400-2.000 ppm
		0-2.000 ppm
		0-5.000 ppm
		0-10.000 ppm
		selectable ranges with DIP switch
Connections	X1-X2 Terminals	Pluggable screw terminal
	X3 Terminals	Fixed screw terminal
	Cable	maximum 1.5mm ²
	Cable Gland	M16
Protection	Enclosure	IP65 or NEMA 4
	Probe	IP65 or NEMA 4
Standards	EMC Directive	EN 61326-1
Weight Packed	300 grams	
Display	For CO2D types supplied with display the display type is LCD with visual area 25x40 mm	

General Notes

- 1.. High density of some other gasses may effect the reading.
- 2.. Observe maximum permissible cable lengths.
- 3.. If cable runs parallel to the mains cable: Use shielded cables.
- 4.. Test only with certified calibration gasses.
- 5.. The cable entry always should have to be pointing downwards.
- 6.. The data indicated under 'Technical Data' apply only to vertically mounted transmitters.
- 7.. Wall type transmitters should have to be mounted in the center of wall but not near to any doors and windows

DIP Switch Settings

1.. Please check if there is any special instruction on the enclosure or inside the cover

DIP	CO2 Ranges
	400-2.000 ppm
	0-2.000 ppm
	0-5.000 ppm
	0-10.000 ppm

Electrical Connections

- 1.. Please be sure about current direction for current outputs and polarity for voltage outputs.
- 2.. Relay contact is Normally Open and rating is max. 1A at 230VAC
- 3.. We kindly advise using 24V for avoiding high voltage harmonics and external power relay for bigger loads
- 4.. Please use shielded and twisted paired cables for Modbus connections
- 5.. Please observe RS485 termination rules, max. 32 devices in a single Modbus line

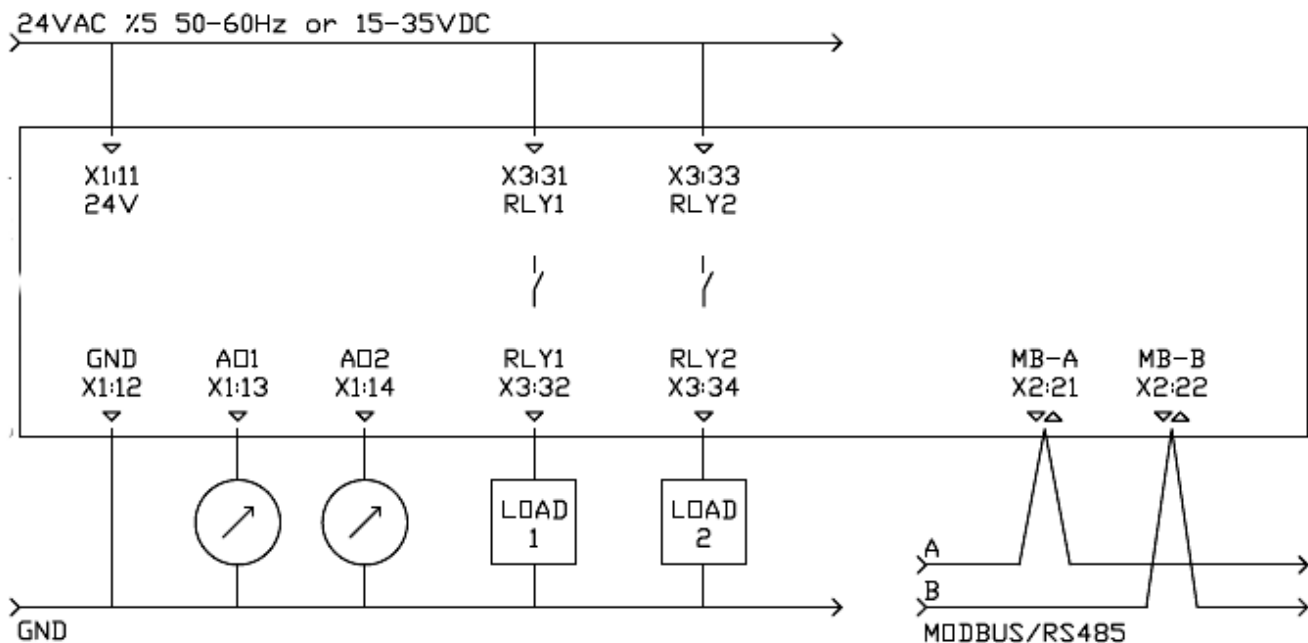

Transmitter Hardware

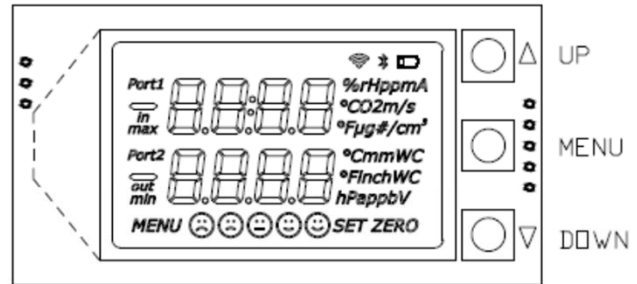
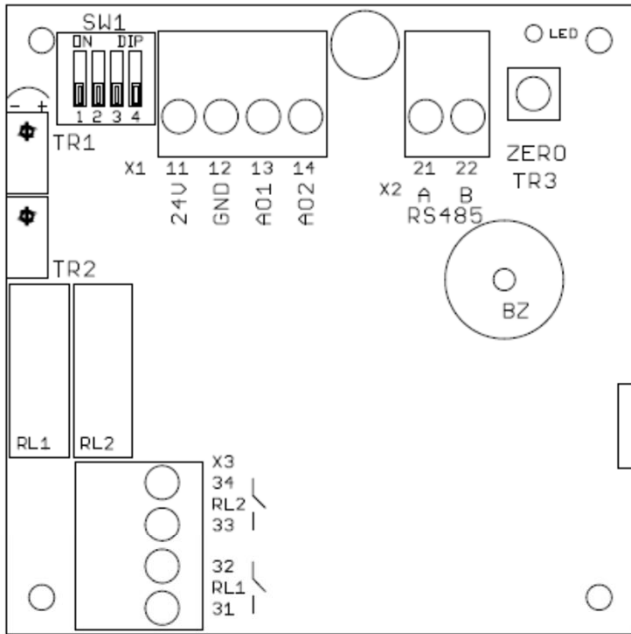

SW1 DIP Switch for configuration range and response time

X1 TERMINAL

11	24V	15...35 Vdc or 24 Vac (± %5, 50-60 Hz)
12	GND	ground for power and reference for outputs
13	AO1	analog output 1
14	AO2	analog output 2

X2 TERMINAL

21	A / RS485	modbus communication positive pair
22	B / RS485	modbus communication negative pair

LED bead LED, periodically lights ON and OFF
modbus communication, blinks when there is a communication

TR1 not used

TR2 not used

ZERO / TR3 not used

RL1 & RL2 relay 1 and relay 2

BZ buzzer

X3 TERMINAL

31	NO - RL1	relay 1 dry contact max. rating 1A @ 220 Vac
32	NO - RL1	relay 1 dry contact max. rating 1A @ 220 Vac
33	NO - RL2	relay 2 dry contact max. rating 1A @ 220 Vac
34	NO - RL2	relay 2 dry contact max. rating 1A @ 220 Vac

Display and Buttons

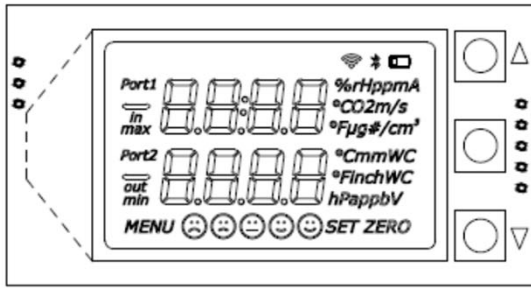

- UP *press for increasing the value or choosing the next parameter*
- MENU *press and wait to enter MENU, click to navigate between sub menus one by one*
- DOWN *press for decreasing the value or choosing the previous parameter*

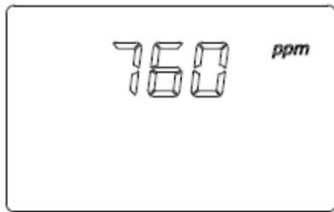

main screen
transmitter is working



keep pressing MENU button until seeing SET
transmitter is not working in MENU mode

Parameters for Relay and Buzzer

Main Screen >>>>> r1 L > r1 H > r1 A > r2 L > r2 H > r2 A > BL > BH > BA > Main Screen

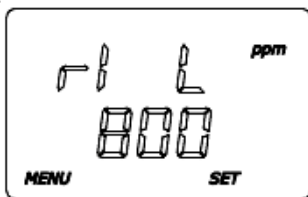

LOW set point for Relay 1

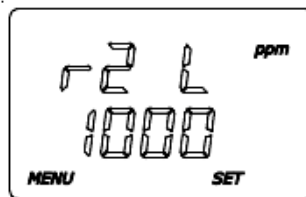

LOW set point for Relay 2

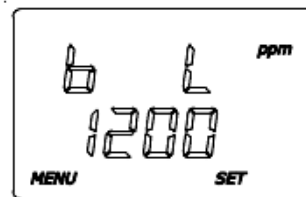

LOW set point for Buzzer

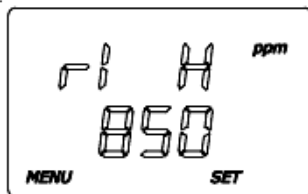

HIGH set point for Relay 1

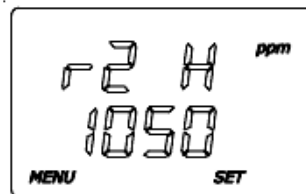

HIGH set point for Relay 2

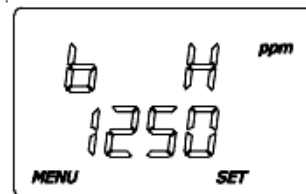

HIGH set point for Buzzer

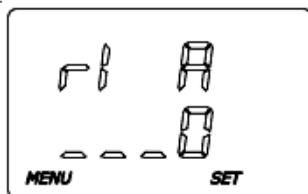

ACTION selection for Relay 1

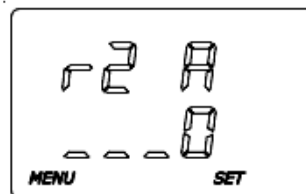

ACTION selection for Relay 2

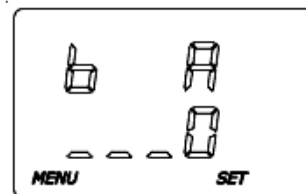

ACTION selection for Buzzer

Actions for Relay and Buzzer

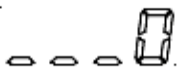

action 0, valid for relays and buzzer,
 relay contact is always OPEN
 buzzer is always SILENCE

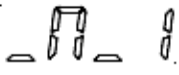

action 1, valid for relays and buzzer,
 relay contact is CLOSED between points, OPEN under LOWpoint and OPEN over HIGHpoint
 buzzer is WARNING between points, SILENCE under LOWpoint and SILENCE over HIGHpoint



action 2, valid for relays and buzzer,
 relay contact is OPEN between points, CLOSED under LOWpoint and OPEN over HIGHpoint
 buzzer is SILENCE between points, WARNING under LOWpoint and SILENCE over HIGHpoint

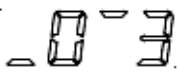

action 3, valid for relays and buzzer,
 relay contact is CLOSED over HIGHpoint, OPEN under LOWpoint, hysteresis between points
 buzzer is WARNING over HIGHpoint, SILENCE under LOWpoint, hysteresis between points



action 4, valid for relays and buzzer,
 relay contact is OPEN over HIGHpoint, CLOSED under LOWpoint, hysteresis between points
 buzzer is SILENCE over HIGHpoint, WARNING under LOWpoint, hysteresis between points



action 5, valid only for buzzer,
 buzzer is WARNING over HIGHpoint, SILENCE under LOWpoint,
 buzzer is WARNING intermittently between points,

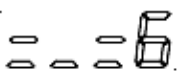

action 6, valid only for buzzer,
 buzzer is WARNING under LOWpoint, SILENCE over HIGHpoint,
 buzzer is WARNING intermittently between points,



action 7, valid only for buzzer,
 buzzer is following relay 1 contact,
 buzzer is WARNING when relay 1 contact is CLOSED, SILENCE when the contact is OPEN

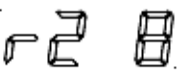

action 8, valid only for buzzer,
 buzzer is following relay 2 contact,
 buzzer is WARNING when relay 2 contact is CLOSED, SILENCE when the contact is OPEN

Cont.. Actions for Relay and Buzzer

ACTIONS	under LOW	between LOW & HIGH	over HIGH
0 : 0.0.0	Open / Silence	Open / Silence	Open / Silence
1 : 0.I.0	Open / Silence	Closed / Warning	Open / Silence
2 : I.0.I	Closed / Warning	Open / Silence	Closed / Warning
3 : 0.X.I	Open / Silence	Hysteresis	Closed / Warning
4 : I.X.0	Closed / Warning	Hysteresis	Open / Silence
5 : 0.-.I	Silence	Pre Alarm	Warning
6 : I.-.0	Warning	Pre Alarm	Silence
7 : =r1	Silence when RL1 is Open, Warning when RL1 is Closed		
8 : = r2	Silence when RL2 is Open, Warning when RL2 is Closed		

0 : Relay Contact is OPEN, Buzzer is in Silent mode

I : Relay Contact is CLOSED, Buzzer is in Warning mode

X : Relay Contact is at HYSTERESIS position, OPEN if previous position open, CLOSED if previous position closed
 : Buzzer is in HYSTERESIS mode, Silent if previous mode is silent, Warning if previous mode is warning

- : Buzzer is in PRE ALARM mode, Buzzer is warning intermittently

Modbus RS485 Protocol

Default Settings: Modbus ID:1, 9600, 8bit, None, 1. Register Table starts from Base 1.

Use Function 3 for Reading and Function 6 for Writing Holding Registers.

Whenever writing to any Modbus Parameter, new parameter is activated instantly and you should have to configure master device according to new parameters.

For every reboot/initializing, Modbus is activated with default parameters for 3 seconds.

After 3 seconds, Modbus is reconfigured according your parameter settings.

Unlisted registers are for analog output calibrations and some system parameters.

Please do not change unlisted registers..

Register	R/W	Range	Description
1	R & W	1...254	Modbus Address
2	R & W	0...4	Baudrate, 0: 9.600, 1: 19.200, 2: 38.400, 3: 57.600, 4: 115.200
3	R & W	0...3	Bit_Parity_Stop, 0: 8bit_None_1, 1: 8bit_None_2, 2: 8bit_Even_1, 3: 8bit_Odd_1
4	R		CO2 level as ppm
5	R		Temperature as C x100, divide by 100 for exact value
6	R	0 or 1	Relay 1, contact position, 0: OFF - Contact is Open, 1: ON - Contact is Closed
7	R	0...1.000	Relay 1, LOW point
8	R	0...1.000	Relay 1, HIGH point
9	R	0...4	Relay 1, ACTION
10	R	0 or 1	Relay 2, contact position, 0: OFF - Contact is Open, 1: ON - Contact is Closed
11	R	0...1.000	Relay 2, LOW point
12	R	0...1.000	Relay 2, HIGH point
13	R	0...4	Relay 2, ACTION
14	R	0 or 1	Buzzer, 0: OK-Silence, 1: PreAlarm - warning intermittently, 2: WARNING continuously
15	R	0...1.000	Buzzer, LOW point
16	R	0...1.000	Buzzer, HIGH point
17	R	0...4	Buzzer, ACTION
18-29	R		Only for service needs
30	R		CO2 level as ppm
31	R		Temperature as C x100, divide by 100 for exact value
32	R		Temperature as C
33	R		Temperature as F x100, divide by 100 for exact value
34	R		Temperature as F
35	R		Humidity as %rH x100, divide by 100 for exact value
36	R		Humidity as %rH

Dimensions (mm)

